



Massachusetts Institute of Technology
77 Massachusetts Avenue, 24-215
Cambridge, MA 02139-4307

(617) 452-2660
canes@mit.edu
mit.edu/canes



ADVANCED NUCLEAR POWER PROGRAM

MIT-Japan Study

Future of Nuclear Power in a Low-Carbon World: The Need for Dispatchable Energy

**Charles Forsberg, Richard Lester, Nestor Sepulveda,
and Geoffrey Haratyk**

Massachusetts Institute of Technology, Department of Nuclear Science and Engineering; 77 Massachusetts Ave., Cambridge, MA 02139

Akira Omoto and Tomihiro Taniguchi,

Tokyo Institute of Technology, 2-12-1, Ookayama, Meguro-ku, Tokyo, Japan

Ryoichi Komiyama and Yasumasa Fujii

The University of Tokyo, Department of Nuclear Engineering and Management, Graduate School of Engineering, 7-3-1, Hongo, Bunkyo-ku, Tokyo, Japan

Kazuaki Matsui

Institute of Applied Energy, Shimbashi SY-Building, 1-14-2, Nishi-Shimbashi, Minato-ku, Tokyo, Japan

Xing. L. Yan

Japan Atomic Energy Agency, 4002, Narita-cho, Ooarai, Higashi-Ibaraki-gun, Ibaraki-ken, Japan

Tomofumi Shibata and Tomoko Murakami

Institute of Energy Economics Japan, Inui-Building, 1-13-1, Kachidoki, Cyuou-ku, Tokyo, Japan

MIT-ANP-TR-171

September 2017

For Public Distribution

MIT-Japan Study

Future of Nuclear Power in a Low-Carbon World: The Need for Dispatchable Energy

Charles Forsberg¹
Akira Omoto²
Richard Lester¹
Ryoichi Komiyama³
Yasumasa Fujii³
Tomihiro Taniguchi²
Nestor Sepulveda¹
Geoffrey Haratyk¹
Kazuaki Matsui⁴
Xing. L. Yan⁵
Tomofumi Shibata⁶
Tomoko Murakami⁶

¹Massachusetts Institute of Technology, Department of Nuclear Science and Engineering; 77
Massachusetts Ave., Cambridge, MA 02139

² Tokyo Institute of Technology, 2-12-1, Ookayama, Meguro-ku, Tokyo, Japan

³The University of Tokyo, Department of Nuclear Engineering and Management, Graduate School of
Engineering, 7-3-1, Hongo, Bunkyo-ku, Tokyo, Japan

⁴ Institute of Applied Energy, Shimbashi SY-Building, 1-14-2, Nishi-Shimbashi, Minato-ku, Tokyo,
Japan

⁵Japan Atomic Energy Agency, 4002, Narita-cho, Ooarai, Higashi-Ibaraki-gun, Ibaraki-ken, Japan

⁶ Institute of Energy Economics Japan, Inui-Building, 1-13-1, Kachidoki, Cyuou-ku, Tokyo, Japan

For Public Distribution

Acknowledgements

The report represents the results of joint studies by the Massachusetts Institute of Technology (MIT) and several institutions in Japan. The MIT contributions were organized by Dr. Charles Forsberg with contributions from Professor Richard Lester, Dr. Geoffrey Haratyk and Nestor Sepulveda. On the part of Japan, the report was primarily authored by Professor Akira Omoto of the Tokyo Institute of Technology, Professor Ryoichi Komiyama and Professor Yasumasa Fujii of the University of Tokyo, Mr. Tomofumi Shibata of IEEJ (the Institute of Energy Economics Japan) and Dr. Xing. L. Yan of the Japan Atomic Energy Agency, with support from Professor Tomihiro Taniguchi of Tokyo Institute of Technology, Mr. Kazuaki Matsui of Institute of Applied Energy, and Ms. Tomoko Murakami of IEEJ. The authors are responsible for the overall content. The authors would like to acknowledge generous financial support from the United States Department of Energy and cooperative arrangements provided by Ministry of Economics, Trade and Industry, the Government of Japan.

CANES PUBLICATIONS

Topical and progress reports are published under seven series:

Advances in Nuclear Energy Disciplines (ANED) Series
Advanced Nuclear Power Technology (ANP) Series
Nuclear Fuel Cycle Technology and Policy (NFC) Series
Nuclear Systems Enhanced Performance (NSP) Series
MIT Reactor Redesign (MITRR) Series
Nuclear Energy and Sustainability (NES) Series
Nuclear Space Applications (NSA) Series

Please visit our website (mit.edu/canes/) to view more publication lists.

MIT-ANP-TR-171	C. W. Forsberg, et al. MIT-Japan Study Future of Nuclear Power in a Low-Carbon World: The Need for Dispatchable Energy (September 2017)
MIT-ANP-TR-170	C. W. Forsberg, et al. Light Water Reactor Heat Storage for Peak Power and Increased Revenue: Focused Workshop on Near-Term Options (July 2017)
MIT-ANP-TR-169	J. Conway, N. Todreas, Offshore Floating Nuclear Plant (OFNP): A (July 2017)
MIT-ANP-TR-168	G. N. Genzman, N. Todreas, R. Abeyaratne, and M. Dahleh, Ship Collision and the Offshore Floating Nuclear Plant (OFNP): Analysis of Possible Threats and Security Measures (September 2016)
MIT-ANP-TR-167	K. Shirvan, G. Daines, K. P. So, A. Mieloszyk, Y. Sukjai, and Ju Li, Silicon Carbide Performance as Cladding for Advanced Uranium and Thorium Fuels for Light Water Reactors , (August 2016)
MIT-ANP-TR-166	C. W. Forsberg, S. Lam, D. M. Carpenter, D. G. Whyte, R. Scarlat, C. Contescu, L. Wei, J. Stempien, and E. Blandford, Tritium Control and Capture in Salt-Cooled Fission and Fusion Reactors: Status, Challenges and Path Forward (May 2016)
MIT-ANP-TR-165	C. Forsberg, D. Carpenter, D. Whyte, R. Scarlat, and L. Wei, Tritium Control and Capture in Salt-Cooled Fission and Fusion Reactors: Experiments, Models, and Benchmarking (January 2016)
MIT-ANP-TR-164	J. Zhang, J. Buongiorno, M.W. Golay, N.E. Todreas, Safety Analysis of OFNP-300 and OFNP-1100 (for design basis events) (November 2015).
MIT-ANP-TR-163	J. Stempien, R. Ballinger, C. Forsberg, M. Kazimi, Tritium Transport, Corrosion, and Fuel Performance Modeling in the Fluoride Salt-Cooled High-Temperature Reactor (FHR) (September 2015).
MIT-ANP-TR-162	C. Forsberg, Strategies for a Low-Carbon Electricity Grid with Full use of Nuclear, Wind and Solar Capacity to Minimize Total Costs (August 2015).

MIT-ANP-TR-161 A. Briccetti, J. Buongiorno, M.W. Golay, N.E. Todreas, **An Analysis of the Spreading of Radionuclides from a Vent of an Offshore Floating Nuclear Power Plant** (2015).

MIT-ANP-TR-160 J. Jurewicz, J. Buongiorno, M.W. Golay, N.E. Todreas, **Design and Construction of an Offshore Floating Nuclear Power Plant** (June 2015).

MIT-ANP-TR-159 Matthew Brian Strother, J. Buongiorno, M.W. Golay, N.E. Todreas, **Hydrodynamic Analysis of the Offshore Floating Nuclear Power Plant** (2015).

MIT-ANP-TR-158 Jacob DeWitte, N.E. Todreas, R. Ballinger, **Maximizing Nuclear Power Plant Performance via Mega-Uprates and Subsequent License Renewal** (January 2015).

MIT-ANP-TR-157 Charles Forsberg, Lin-Wen Hu, Per Peterson and Kumar Sridharan, **Fluoride-Salt-Cooled High-Temperature Reactor (FHR) for Power and Process Heat** (December 2014).

MIT-ANP-TR-156 Nghia T. Nguyen and Neil E. Todreas, **An Inverted Pressurized Water Reactor Design With Twisted-Tape Swirl** (June 2014).

MIT-ANP-TR-155 K. Shirvan, R. Ballinger, J. Buongiorno, C Forsberg, M.S. Kazimi, N.E. Todreas, **Advanced Offshore Seabed Reactors** (April 2014).

MIT-ANP-TR-154 C. Forsberg, L-W. Hu, J. Richard, R. Romatoski, B. Forget, J. Stempien, R. Ballinger, **Fluoride-Salt-Cooled High-Temperature Test Reactor (FHTR): Goals, Options, Ownership, Requirements, Design, Licensing, and Support Facilities** (December 2014).

MIT-ANP-TR-153 C. Forsberg, D. Curtis, J. Stempien, R. MacDonald, P. Peterson, **Fluoride-Salt-Cooled High-Temperature Reactor (FHR) Commercial Basis and Commercialization Strategy. A Fluoride-Salt-Cooled High-Temperature Reactor (FHR) with a Nuclear Air-Brayton Combine Cycle (NACC) and Firebrick Resistance-Heated Energy Storage (FIRES)** (December 2014).

MIT-ANP-TR-152 A. Briccetti, J. Buongiorno, M. Golay, N. Todreas, **Siting of an Offshore Floating Nuclear Power Plant** (May 2014).

MIT-ANP-TR-151 M.J. Minck, and C. Forsberg, **Preventing Fuel Failure for a Beyond Design Basis Accident in a Fluoride Salt Cooled High Temperature Reactor** (January 2014).

MIT-ANP-TR-150 Y-H. Lee, T. McKrell, and M.S. Kazimi, **Safety of Light Water Reactor Fuel with Silicon Carbide Cladding** (January 2014).

MIT-ANP-TR-149 Y. Sukjai, E. Pilat, K. Shirvan, and M.S. Kazimi, **Silicon Carbide Performance as Cladding for Advanced Uranium and Thorium Fuels for Light Water Reactors** (January 2014).

MIT-ANP-TR-148 Bloore DA, Pilat EE, Kazimi MS. **Reactor Physics Assessment of Thick Silicon Carbide Clad PWR Fuels** (July 2013).

MIT-ANP-TR-147 Forsberg C, Hu L-wen, Peterson PF, Sridharan K. **Fluoride-Salt-Cooled High-Temperature Reactors (FHRs) for Base-Load and Peak Electricity, Grid Stabilization, and Process Heat** (June 2013).

MIT-ANP-TR-146 Tingzhou Fei, E. Shwageraus, and M. J. Driscoll, **Innovative Design of Uranium Startup Fast Reactors** (November 2012).

MIT-ANP-TR-145 K. Shirvan and M.S. Kazimi, **Development of Optimized Core Design and Analysis Methods for High Power Density BWRs** (November 2012).

Table of Contents

Section	Page
Acknowledgements	3
CANES Publications	5
Table of Contents	7
Table of Figures	9
Table of Tables	11
List of Acronyms	12
Executive Summary	15
1. Introduction	23
1.1. Global Energy Considerations	24
1.2. Changes in Energy Systems	24
1.2.1. Paradigm Shift to a Lower-Carbon World	25
1.2.2. Paradigm shift: Electric sector changes	26
1.2.3. Paradigm Shift: Shift of energy to non-OECD and East	30
1.3. Major Findings of Phase I Study	30
1.4. Requirements	31
1.5. Report Structure	31
2. Technology Options for Nuclear Energy Replacing Fossil Fuels	34
2.1. The Challenge	35
2.2. Dispatchable Electricity with Base-load Reactors and Heat Storage	39
2.2.1. Heat Storage Coupled to Reactors with Steam Power Cycles	41
2.2.2. Electricity to Heat Storage	47
2.2.3. Nuclear Brayton Cycles with FIRES and Brick Recuperator Heat Storage	50
2.2.4. Heat Storage in the Reactor Core	55
2.2.5. Dispatchable Electricity for a Low-Carbon World	57
2.3. Non-Electrical Energy Systems: Heat, Energy Carriers, and Hydrocarbon Fuels	58
2.3.1. System Characteristics	58
2.3.2. Heat Economy	61
2.3.3. Energy Carriers: Hydrogen, Ammonia and others	62
2.3.3.1. Hydrogen	62
2.3.3.2. Ammonia	67
2.3.4. Liquid Hydrocarbon Fuels Production	68
2.3.4.1. Biofuels	69
2.3.4.2. Liquid Hydrocarbon Fuels from Air and Ocean Seawater	71
2.4. Gen-III+/IV Reactor Technologies	74
2.4.1. Light Water Reactors	75
2.4.2. High-Temperature Reactors	75
2.5. Small Modular Reactors	77
2.6. Observations and Recommendations on Technology Options	77
3. Market Mechanism Options	82
3.1. Markets	82
3.2. Different U.S./Japan Challenges	82
3.3. Mechanisms to Modify Market Behavior	84
3.3.1. Carbon price	85

3.3.2. Direct financial support: FIT, CfD, ZEC	86
3.3.2.1 FIT-CfD	86
3.3.2.2 ZEG	87
3.3.2.3 Clean Portfolio Standard	89
3.3.3. Clean Capacity Mechanism	90
3.3.4 French AREHN System	92
3.3.5. Other Conceivable Mechanisms	93
4. Models	95
4.1. MIT GenX Model	95
4.2. University of Tokyo Optimal Power Generation Mix Model (UT, Japan: Fujii)	100
4.3. Other Models	104
4.4. Conclusions	106
5. Conclusions and Recommendations	108
Appendix A: Impact of Large Scale Solar: The California Duck Curve	A-1
Appendix B: High Temperature Gas-cooled Reactor (HTGR) with Hydrogen and Variable Electric Production	B-1
B.1. HTGR Development in Japan	B-1
B.2. Hydrogen Production	B-4
B.3. Hybrid production system by HTGR	B-8
Appendix C: Case Studies of Global Hydrogen Demand/Supply from Low-Carbon Resources Toward 2050	C-1
Appendix D: Reactor Heat Storage Options for Base-Load Reactors with Variable Electricity and Steam Output	D-1
D.1. Reactor Constraints	D-1
D.2. Thermal Storage Options	D-4
D.2.1. Steam Accumulators (Direct hot water/steam storage)	D-5
D.2.2. Heat Storage (oil, salt, etc.) In Secondary Low-Pressure Media	D-8
D.2.3. Cryogenic Liquid Air Storage	D-11
D.2.4. Pressurized Counter-Current Condensing-Steam Solid Heat Storage	D-12
D.2.5. Atmospheric-Pressure Crushed-Rock Heat Storage	D-14
D.2.6. Nuclear Geothermal Heat Storage	D-16
D.3. Choice of Heat Storage Technology	D-20
D.3.1. Technology Characteristics of Different Storage Systems	D-20
D.3.2. Operational Strategies: Differences between Heat Storage and Electricity Storage	D-21
D.4. References	D-23

Table of Figures

Section	Page
Fig. 1.1. Human Development Index versus Annual Per Capita Electricity Consumption	24
Fig. 1.2. Historical and Predicted Global Energy Consumption from the International Energy Outlook 2016 Report	25
Fig. 1.3. Changing Structure of the Electricity Grid	28
Fig. 1.4. In the 2008 electricity cost supply stack (left), natural-gas combined-cycle gas turbines (CCGT) units are more expensive to dispatch than coal-fired units. In 2015 (right), the situation has been reversed and coal is displaced by CCGT.	29
Fig. 1.5. Outline of the Report Structure	32
Fig. 2.1. Solar PV Market Income and Average Wholesale Electricity Prices versus Solar PV Penetration	36
Fig. 2.2. Projected Normalized Revenue for Solar and Nuclear for Tokyo Electric as Solar Generating Capacity is Increased	37
Fig. 2.3. Hourly Wholesale Electricity Prices in Western Iowa over Two Years	38
Fig. 2.4. Impact of Wind Penetration into the MISO Market on Wind and Nuclear Power Plant Revenue	39
Fig. 2.5. Westinghouse Thermal Heat Storage Module for 1 MWh of Electricity Storage	43
Fig. 2.6. Packed Bed Heat Storage System	44
Fig. 2.7. Schematic of Hot-Rock Heat Storage in Charging Mode	44
Fig. 2.8. Impact of Addition of Solar to the California Electricity Market on a Spring Day and Nuclear Storage Strategy to Address Changes in Market	46
Fig. 2.9. Configuration of FIRES coupled with an industrial process	47
Fig. 2.10. Potential Impact of FIRES on Nuclear and Solar Plant Revenue	49
Fig. 2.11. Grid Perspective of High-Temperature Reactor with Supplemental Natural Gas Firing and FIRES	50
Fig. 2.12. NACC with Heat Storage and Use of Auxiliary Fuels (Natural Gas, Hydrogen, Stored Heat [FIRES and Brick Recuperator], Other)	51
Fig. 2.13. Nuclear Air-Brayton Combined Cycle (NACC)	53
Fig. 2.14. Schematic of GTHTR300C Power System	55
Fig. 2.15. Reactor Response to Provide Variable Output on a Minute Scale	56
Fig. 2.16. Japanese HTGR Program	56
Fig. 2.17. Integrated Energy Network	58
Fig. 2.18. Energy Consumption in Quads by Sector in the United States	59
Fig. 2.19. Energy Consumption by Sector (Energy Balance Flow 2012) in Japan	60
Fig. 2.20. Theoretical Energy Input for High-Temperature Electrolysis	63
Fig. 2.21. Iodine Sulfur Process for Production of Hydrogen from Water	64
Fig. 2.22. Schematic of GTHTR300C nuclear steelmaking system based on a unit of nuclear reactor	65
Fig. 2.23. 2009 Operating Hours per Year for Electricity Peaking Plants in MISO [2010]	67
Fig. 2.24. Conceptual figure of carbon-free ammonia energy system	68
Fig. 2.25. Cost of Biomass Feedstock vs. Price of Petroleum	70
Fig. 2.26. Schematic figure of direct air capture (DAC)	72
Fig. 2.27. Schematic figure of a plant for CO ₂ capture from air that uses NaOH as the absorber	73
Fig. 2.28. Electrolytic Catalytic Exchange Membrane Module to Recover Carbon Dioxide, Hydrogen, and Oxygen from Seawater	74
Fig. 3.1. U.S. Wholesale Electricity Prices versus Time	83
Fig. 3.2. Creation of base load market	93
Fig. 4.1. 2050 Minimum-Cost Texas Grid vs. Allowable Generation Technologies and CO ₂ Emissions in g/kWh.	97
Fig. 4.2. Optimal 2050 Texas Installed Capacity vs. Added Technologies and CO ₂ Limits	98

Fig. 4.3.	Geographical Distribution of High Voltage Power Transmission Lines and Nodes in OPGM Model	101
Fig. 4.4.	Schematic Diagram of MIT FIRES in OPGM Model	101
Fig. 4.5.	Price Duration Curves in Hokkaido	102
Fig. 4.6.	Optimal Power Generation Mix Mode Combined with RES-Based Hydrogen Storage	103
Fig. 4.7.	Breakdown of Wind Power Output for Grid Supply, Hydrogen Production and Curtailment	104
Fig. 4.8.	Installed Capacity for Low-Carbon Wind and Solar Power Systems Relative to Capacity of Current Systems	105
Fig. 4.9.	Energy Storage Capacity Required in 100% Renewable Electric Scenarios	106
Fig. A.1.	California “Duck Curve” of Dispatchable Demand for Electricity versus Time Over a Spring Day as More Solar is Added to the California Electrical Grid	A-1
Fig. A.2.	Wholesale electricity prices over 24 hours During the Second Sunday of April in 2012 and 2017	A-2
Fig. A.3.	Electricity Production	A-2
Fig. B.1.	HTTR – a VHTR test reactor constructed at JAEA Oarai R&D Center	B-1
Fig. B.2.	Japan’s VHTR system – GTHTR300C with cogeneration options	B-2
Fig. B.3.	HTTR-GT/H ₂ for demonstrating HTGR hydrogen cogeneration on HTTR	B-4
Fig. B.4.	Principle of thermochemical IS process for nuclear hydrogen production	B-4
Fig. B.5.	HTGR-based hydrogen cogeneration process (GTHTR300C)	B-5
Fig. B.6.	Nuclear hydrogen cogeneration plant arrangement (GTHTR300C)	B-6
Fig. B.7.	HTGR renewable energy hybrid system for grid stability	B-9
Fig. B.8.	Basic control scheme for GTHTR300C	B-10
Fig. B.9.	Reactor response to daily renewable power generation variation	B-10
Fig. B.10.	Reactor response to renewable power generation variation of minute scale	B-11
Fig. B.11.	Reactor response to renewable power generation variation of second scale	B-12
Fig. C.1.	Share of global hydrogen demand in the climate policy case	C-3
Fig. C.2.	CO ₂ emission reduction contributions in the world	C-3
Fig. C.3.	Schematic of GTHTR300C nuclear steelmaking system based on a unit of nuclear reactor	C-5
Fig. D.1.	Typical 1200 MWe Pressurized Water Reactor Plant Cycle Efficiency vs. Power Level	D-2
Fig. D.2.	PWR Steam Plant with Selected Options for Steam Removal and Return to Turbine Plant	D-4
Fig. D.3.	Steam Accumulator Schematic	D-5
Fig. D.4.	Alternative Accumulator Options: Steel Vessel Charlottenburg Power Station Accumulators Built in Berlin in 1929 (Upper Left), Proposed Pipe Rack Accumulator (Lower Left) and Prestressed Concrete Vessel (PCV) (Right, Proposed Adele PCV for Adiabatic Compressed Air Storage System [Zunft, 2014]; Schematic (right) courtesy of Zublin)	D-6
Fig. D.5.	Nuclear Thermal Energy Storage System (Charging Mode)	D-9
Fig. D.6.	Westinghouse Thermal Heat Storage Module for 1 MWh of Electricity Storage	D-10
Fig. D.7.	A schematic diagram of the cryogenic energy storage technology	D-11
Fig. D.8.	Highview 5MW/15MWh Commercial Demonstration plant in Manchester Integrated with Viridor Biogas Power Plant	D-12
Fig. D.9.	Operation of Pressurized Counter-Current Heat Storage	D-13
Fig. D.10.	Atmospheric Steam as Heat Transfer Fluid and an Alumina Packed Bed as Storage Media, X-ray and IR Images Every 10 Seconds	D-14
Fig. D.11.	Hot Rock Storage with Steam and Electric Input	D-15
Fig. D.12.	Nuclear Geothermal Heat Storage	D-16
Fig. D.13.	Fractional Energy Losses vs. Cycle for Three Reservoir Sizes	D-17
Fig. D.14.	An Earth Battery System with CO ₂ is Shown	D-19
Fig. D.15.	Alternative Buy and Sell Strategies for Batteries (Sell Limited Hours) and Nuclear Heat Storage (Sell Many Hours) in California Electricity Market, Spring Day Shown	D-22

Table of Tables

Section	Page
Table 2.2. Annual Carbon Dioxide Emissions from Japan in FY 2014	64
Table 2.3. Basic Plant Parameters of the Nuclear Steel System based on 600 MWth HTGCR	65
Table 2.4. Comparison of Options for Producing Hydrocarbon Fuels from Biomass	70
Table 3.1. Putting a price on carbon lowers CO2 emissions and increases the wholesale price of electricity, which would benefit nuclear plants. The price increase for consumer could be partly alleviated by charging the polluters for the cost of carbon damage (simulation results obtained with 2015 energy mix)	86
Table B.1. Major Technical Parameters (GTHTR300C)	B-2
Table B.2. GTHTR300C parameter for hydrogen cogeneration and storage	B-5
Table B.3. Financial Parameters	B-7
Table D.1. Solar Power Accumulators	D-7
Table D.2. Relative Storage Option Characteristics	D-20

List of Acronyms

ARENH Regulated Access to Incumbent Nuclear Electricity
CCGT combined-cycle gas turbines
CfD Contract-for-Differences
CGNPC China Guangdong Nuclear Power Holding Co.
CRE Commission de régulation de l'électricité
CRIEPI Central Research Institute for Electric Power Companies
DAC Direct Air Capture
E-CEM electrolytic catalytic exchange membrane
EDF Electricite de France
EPA Environment Protection Agency
FERC Federal Energy Regulatory Commission
FHR Fluoride salt-cooled High-temperature Reactor
FIRES Firebrick Resistance-Heated Energy Storage
FIT Feed-In-Tariff
GHG Green House Gas
GNP Gross National Product
GTHTR Gas Turbine High Temperature Reactor
HRSG Heat Recovery Steam Generator
HTE High-Temperature Electrolysis
HTGR High-Temperature Gas-cooled Reactor
HTTR High-Temperature Test Reactor
HTR High Temperature Reactor
IAEA International Atomic Energy Agency
ICE Intercontinental Exchange
IRs Intermittent energy Resources
ISO Independent System Operator
JPY Japanese Yen
LFR Lead-Cooled Fast Reactor
LWR light-water reactor
LNG Liquid Natural Gas
METI Ministry of Economics, Trade and Industry
MISO Midwest Independent System Operator
MIT Massachusetts Institute of Technology
MSR Molten Salt Reactor
NACC Nuclear Air-Brayton Combined Cycle
NAS sodium-sulfur battery
NEPOOL The New England Power Pool
NGNP Next Generation Nuclear Plant

NOME Nouvelle Organisation du Marche de l'Electricite
NYMEX New York Mercantile Exchange
OECD Organization of Economic Cooperation and Development
OPGM Optimal Power Generation Mix
PJM Pennsylvania New Jersey Maryland
PRIS Power Reactor Information System
PTC production tax credit
PV photovoltaics
RES Renewable Energy System
SOFC Solid Oxide Fuel Cell
SGIP Self-Generation Incentive program
SMR Small Modular Reactor
TEPCO (Tokyo Electric Power Company)
ZEC Zero-Emission Credits

MIT-Japan Study: Executive Summary

The Future of Nuclear Power in a Low-Carbon World: The Need for Dispatchable Energy

To address the question of how do we create an economic low-carbon power system with minimum burden to the society, researchers from the Massachusetts Institute of Technology, the University of Tokyo, the Tokyo Institute of Technology, the Institute of Applied Energy, the Japan Atomic Energy Authority and the Institute for Energy Economics Japan undertook a series of studies to address how to make this transition in the context of the Future of Nuclear Power. The goal of affordable energy in a low-carbon world requires low-carbon dispatchable energy sources to replace fossil fuels in that role. Wind and solar photovoltaic are intermittent energy resources (IRs) that require a dispatchable energy source to provide electricity at times of low wind and solar conditions. Nuclear power plants can provide dispatchable heat and electricity by varying power levels but operating at partial load significantly increases the cost of energy.

The mismatch between efficient energy production (fully utilizing the output of nuclear, wind and solar) and demand in a low-carbon world can be partly met by energy storage technologies. The central challenge is cost. Nuclear reactors generate heat that is converted to electricity whereas wind and solar photovoltaic generate electricity directly. The cost of storing heat is *an order of magnitude less than the cost of storing electricity* (batteries, pumped storage, etc.); thus, the opportunity to develop economic heat storage technologies coupled to nuclear to provide a replacement for fossil fuels in their central role of providing economic dispatchable energy to match energy production with demand. Hourly to seasonal heat storage may enable base-load nuclear reactors to provide variable electricity—an expanded role for nuclear energy that becomes the enabling technology for IRs by economically solving the storage challenge. Solar thermal systems also provide heat and couple to thermal storage systems but are limited to areas of high-quality direct sunlight.

The other requirement for deep decarbonization is to develop non-fossil energy carriers (hydrogen, ammonia, non-fossil hydrocarbons) to replace fossil fuels as transportable fuels and in other applications. This will require development of multiple technologies with integrating heat (nuclear) with electricity (nuclear, wind and solar photovoltaic) energy systems for cost effective solutions. Many of the most efficient industrial processes require heat input.

The Challenge to Create a Low-Carbon Energy System

To maintain standards of living in the developed world and to eliminate poverty worldwide will require massive quantities of energy and massive growth in energy resources. Because energy production is about 8% of the gross national product (GNP) of the world, it is essential to avoid large increases in energy costs as that would significantly decrease human welfare. Concerns about climate change have resulted in the goal of deep reductions in greenhouse gas emissions from the energy sector. If resources were unlimited, it would be technically easy to create a low-carbon energy system. The low-carbon energy challenge is that energy production consumes a significant fraction of the world GNP and thus there are severe economic constraints for any low-carbon system that replaces our use of fossil fuels.

Mankind's variable energy needs have been historically met by burning carbon—from wood to coal to oil and natural gas. The resources in capital and labor to build energy conversion systems from cooking stoves to gas turbines to produce electricity and heat are small. Most of the required resources are used to find the fuel (wood, coal, oil, natural gas) and bring it to the fire. The costs of storing these fuels are small. *As a consequence, it is economic to operate fossil energy conversion systems (from cooking stoves to gas turbines) with variable output to match the variable energy needs of mankind.* In economic terms, fossil-fuel systems to meet variable energy demand have low capital costs and high operating costs.

In a low-carbon world the primary energy sources are nuclear, wind and solar. These systems have high capital costs and low fuel costs. If these systems are operated at half their productive capacity, the cost of energy doubles. Wind and solar output depends upon local wind and solar conditions. If one begins to install large solar facilities, by the time solar is producing 15% of the total electricity needs over a year, solar output at times of good solar conditions exceeds electricity needs, solar output is curtailed and the price of electricity collapses to zero. The resources society used to build the solar systems are wasted at such times. The collapse in revenue for solar systems makes it uneconomic to further expand solar. The same occurs with wind as wind output approaches 30%. Because these energy sources are non-dispatchable, they can't meet the variable energy demands of society. Efforts are underway to partly address this challenge by use of dispatchable renewables (biogas, geothermal and small renewables) as well as other mechanisms (batteries, electric car charging times, and time-of-day pricing for consumers). Nuclear plant output can be varied to match production with demand but operating nuclear reactors at part load increases the cost of energy and implies inefficient use of resources. These effects have been seen in parts of Europe, the United States and Japan. While subsidies can force the larger scale use of these low-carbon energy sources, this increases the cost of energy to society. The primary proposed solution to match production with demand has been electricity storage (hydro pumped storage, batteries, etc.) but with large increases in energy costs (see below)

There are major near-term challenges for nuclear energy in Japan and the United States. Those in Japan are primarily due to the Fukushima Daiichi accident. In the United States the development of natural gas fracking has caused a dramatic drop in natural gas prices that has decreased electricity prices and resulted in the closure of some nuclear power plants for economic reasons. Although 60% of U.S. electricity that does not emit greenhouse gases is from nuclear, low natural gas prices will likely cause further closures of nuclear plants. In some parts of the United States, subsidized IRs have also driven down the price of electricity at times of high wind or solar output and hurt nuclear plant economics. Long-term policy objectives, in particular environmental (carbon releases) considerations, are not valued in deregulated markets. Although nuclear power generation has unique features for sustainable development in terms of long-term availability of resources, affordability, clean air, and supply security, its near-term outlook in Japan and the United States is not promising.

In the effort to shift to a low carbon economy, society needs to find an answer to the question “how do we create an economic power system with minimum burden to society by a combination of low-carbon dispatchable and non-dispatchable energy sources, replacing the traditional role of fossil fuels, to fulfill the requirements for a safe, secure, reliable, affordable and environmentally acceptable energy source?”

Changes in Nuclear and Renewable Technologies Are Required for a Low-Carbon World

For the electricity sector the generally proposed strategy to match low-carbon production with demand is storage. The question is how to minimize the cost for hourly-to-seasonal energy storage. Wind and solar photovoltaic produce electricity and therefore couple to electricity storage technologies (hydro pumped storage, batteries, etc.). Nuclear power plants and solar thermal plants produce heat that is then converted into electricity. Heat storage can thus be coupled to nuclear reactors to enable a reactor operating at full capacity to send variable electricity to the grid. Heat storage costs are estimated to be an order-of-magnitude less expensive than electricity storage. The U.S. government goal for the cost of battery storage packs (not the entire system) is \$150/kWh whereas the heat storage goal for solar thermal plants is \$15/kWh. Thermal energy storage systems for storage on scales of hours to years are under development, while no longer-term (weekly to seasonal) electricity storage technologies are under development because of economic considerations. Most new utility-scale solar thermal plants incorporate heat storage to avoid selling electricity to the grid at low prices whereas battery (electricity) storage is not coupled to solar PV systems.

Four categories of heat storage technologies are being developed—each with different characteristics relative to the electricity grid. In each case when connected to a nuclear reactor, the nuclear reactor operates at full power, its most economic mode, with variable electricity to the grid with the additional option of variable heat to industry.

- *Variable electricity from base-load reactors with steam cycles.* There are six classes of technology (steam accumulators, sensible heat, cryogenic air, counter-current pebble bed, hot rock and nuclear geothermal) with storage times from hours to a year or more. Several of these technologies are being used in solar thermal power stations.
- *Conversion of excess electricity with a value less than the competing fossil fuel to high-temperature stored heat for industrial furnaces.* Large-scale nuclear-renewable systems will collapse the price of electricity below that of fossil fuels (on a heating basis) at times of high wind or solar input. A method to productively use this “excess” electricity is required. Firebrick Resistance-Heated Energy Storage (FIRES) uses low-price electricity to heat firebrick to high temperatures. When needed air is blown through the hot firebrick to recover the stored heat as hot air for industrial furnaces and kilns—a partial replacement for burning of fossil fuels. Excess energy when available in the electricity sector is used productively and economically in the industrial sector rather than being wasted.
- *Rapid response variable electricity from high-temperature gas-cooled reactors (HTGRs).* Recent technology advances indicate this power system may allow a HTGR operating at constant power to rapidly vary electricity to the grid on demand using the heat storage capacity associated with the reactor core.
- *Buy and sell electricity based on market conditions and need.* High-temperature reactors coupled to Nuclear Brayton Cycles have the potential to buy and sell electricity as required. These advanced power cycles include a high-temperature topping cycle with FIRES and efficient

methods to convert electricity to heat and back to electricity.

Heat storage technologies can be coupled to nuclear reactors that may enable nuclear reactors to provide economic energy storage to provide reliable dispatchable electricity as required by society. Low-cost heat storage becomes the enabling technology to enable larger-scale use of IRs. It is a synergistic relationship where the relative amounts of nuclear, wind, and solar will ultimately depend upon technology and the local cost of high-quality wind or solar resources.

The second challenge is decarbonization of the non-electricity sectors of society. Historically there has been little coupling between these sectors—each with its own supply chain of fossil fuels. Options to meet this challenge include hybrid energy systems for production of products such as hydrogen (clean fuels or peak electricity), ammonia, liquid hydrocarbon fuels, and industrial heat. Most of these products require some mixture of heat and electricity inputs—often heat inputs as high as 850°C such as desired for the Iodine Sulfur (IS) process for hydrogen production from water.

Associated with the second decarbonization challenge is the third renewable: biofuels. It is a major option in the United States but a minor option for Japan. Estimates are that there is potentially sufficient biomass to globally meet current liquid fuels needs—a quarter of global energy needs. The quantities of biofuels produced per unit of biomass are strongly dependent upon the added heat and hydrogen provided from other energy sources (nuclear, wind and solar) during processing with the potential to almost double liquid fuel per ton of biomass with large external energy inputs. This implies that biofuels processing could become the second largest energy market after electricity in a low-carbon world. However, there are serious coupled biomass policy questions:

- **Land use.** How much global land area should be reserved for other human activities (cities, food production, etc.) and the environment versus used to produce biomass for energy? Some energy crops co-produce food (human and animal) and energy but other options would produce biomass only for energy.
- **Carbon sequestration.** Should harvested biomass be used for carbon capture from the atmosphere with carbon sequestration as char or carbon dioxide to reduce the atmospheric concentrations of carbon dioxide? Plants are an efficient mechanism to remove carbon dioxide from the atmosphere. Some bioprocessing options can produce a char or a pure carbon dioxide stream for carbon sequestration. However, such options significantly reduce energy output per ton of biomass.
- **Liquid fuels.** Should biofuels be primarily used to produce liquid fuels for the transport sector? For applications from aircraft to heavy trucks to ships, there are no good alternatives to liquid fuels.

Because of limited global land area and limited planetary biomass, we conclude that biomass will be important for liquid fuels production but is not likely to play a significant role on a global scale as a stationary dispatchable energy source. The competing uses of biomass for land, carbon sequestration and liquid fuels are higher priorities.

Much of the work on hybrid systems (including those with biofuels) will be how to integrate nuclear heat with IR electricity for the production of a second product as a second route to use excess low-price

electricity by producing a storable product—an alternative to heat storage for electricity production. The same heat storage technologies that can help manage the non-dispatchability of IRs are central to many of these hybrid systems. The status of technology development for hybrid systems lags that for heat and electricity storage.

Historically research and development on advanced reactors has been based on (1) economics of base-load electricity, (2) sustainability involving fuel cycles and (3) safety. *Our thesis is that if nuclear energy is to fully contribute to a low carbon world a fourth criterion is required in developing advanced reactors—dispatchable energy to electricity and heat markets.* The addition of this criterion will change research, development and deployment priorities. As important as the reactor development are the power cycles, heat storage, and energy delivery systems that have been discussed. These include Brayton power cycles, multiple heat storage technologies that directly couple to reactors, FIRES, and the technologies for long-distance transport of heat as a commodity.

Changes in Regulatory and Other Policies are required for a Low-Carbon World

The challenge for a low-carbon energy system is developing and deploying technologies that meet the economic requirements of society. *Markets provide the most efficient mechanism to minimize economic costs to society but do not consider societal environmental or security constraints.* Market rules can be used to enable markets to include these goals. *There are several options to utilize markets to minimize societal costs while meeting low-carbon goals.*

- *Carbon taxes.* A carbon tax on fossil fuels is the most efficient mechanism to reduce carbon dioxide emissions. Efforts to first reduce carbon emissions from the electricity sector may raise electricity rates that would result in other industries increasing their direct use of fossil fuels to minimize electricity consumption. Such transfers of carbon dioxide emissions between different sectors of the economy are avoided with a carbon tax. Putting a price on carbon is a political challenge. The low level of carbon taxes in the U.S. (some states) and Japan (indirect taxing) are insufficient to give nuclear a competitive advantage over fossil fuels. In the U.S. there are proposals for revenue-neutral carbon taxes where revenue is rebated equally to every citizen. This may avoid many of the social impacts of carbon taxes while sending a strong signal to the market to reduce carbon emissions.
- *Subsidies for low-carbon electricity.* If subsidies to encourage low-carbon electricity are implemented, subsidies need to be linked with carbon displacement and the market price of electricity. One option is a portfolio standard where the electricity grid operator is required to purchase a certain percentage of the electricity from non-carbon generating technologies with the percentage changing with time. The advantage of a portfolio standard as opposed to a direct subsidy (FIT, ZEC, CfD, etc.) is that the price is set by the market instead of being dictated by the regulator. If there is a single portfolio standard, all clean generation technologies are remunerated at the same price (\$/MWh). Renewables, nuclear, and other technologies would compete on an equal field.

- **Subsidies for low-carbon assured electricity generation capacity.** In most deregulated electricity markets, the electricity grid provides capacity payments (\$/MW) to power generators to assure sufficient generating capacity to avoid blackouts. A more market oriented and innovative approach to value reliable, low-carbon generation capacity could be to add an environmental dimension to capacity mechanisms—capacity payments for low-carbon electricity generators. It would give an instrument for policy makers to ensure that a “cleaner” dispatchable electricity capacity and energy mix is achieved. The European Commission recently proposed to include the environmental dimension to capacity market by excluding generators emitting more than 550g CO₂/ kWh.
- **Subsidies to Encourage Base-load capacity or storage.** This includes options such as “base load market” (discussed in Japan) and subsidies to encourage energy storage capacity on a competitive bidding basis.

Results of Analysis

Energy systems are highly complex. Several different models were used in this study to develop an understanding of the likely evolution of the electricity grid under a wide set of circumstances. These models can also be used to help formulate research and development strategies by understanding the impacts if alternative technologies are successfully developed.

MIT GenX Model analysis of cost of decarbonization of electricity supply

GenX was used to model the electric sector of different Independent System Operators (specifically the Texas electricity grid that has high-grade wind and solar resources) in the U.S. in 2050 as a function of different technology choices and different constraints on carbon dioxide emission to

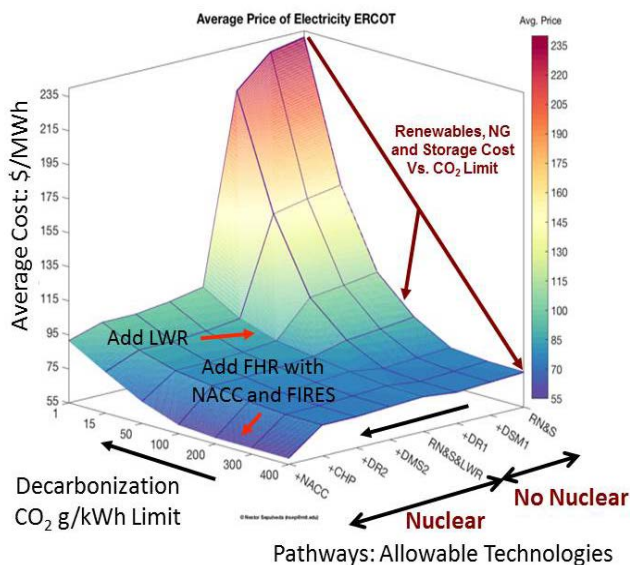

storage technologies (batteries, etc.).

determine the minimum cost generation mix. The analysis of the Texas grid is shown in the figure. Key conclusions are:

- In the United States without carbon constraints, natural gas (NG) produces almost all electricity independent of the other technologies that are available.
- The cost of electricity from a grid with only fossil fuels and IRs and no dispatchable low-carbon technologies will increase rapidly as restrictions are tightened on carbon dioxide emissions compared to an electricity grid with a mixture of dispatchable low-carbon technologies and IRs because of the cost of energy storage. This model assumes the use of standard electricity

- The optimum generation mix of low-carbon electricity sources changes with greenhouse gas emission constraints.
- The addition of dispatchable nuclear energy in the form of light-water reactors (LWRs) substantially reduces the cost of electricity in a low-carbon world relative to a world with only IRs and electricity storage technologies (left side of figure). The same effect would occur with any other low-carbon dispatchable energy technologies with similar cost characteristics. Other low-carbon technologies with that characteristic include fossil fuels with carbon capture and fusion.
- Existing nuclear plants can meet this requirement by going up and down in power; but, large savings are possible if nuclear systems designed for variable power output using heat storage and hybrid production are developed

UT (University of Tokyo) model analysis on the use of FIRES in the grid

A linear programming (optimal power generation mix OPGM) model was used to determine power system cost in the grid with large-scale integration of IRs in Japan, specifically for the case of using Firebrick Resistance-Heated Energy Storage (FIRES), where fluctuating electricity such as IR output is, through resistance heating, stored in fire brick and supplied to satisfy heat requirement in industry. It was concluded that when FIRES becomes economically affordable and is deployed in the Hokkaido area on a large scale, by storing excessive electricity from wind to heat firebrick and later by providing heat for industrial usage when electricity prices are lower, adequately balanced electricity demand and supply is possible and that sharp declines of the electricity price caused by large-scale IRs penetration is largely mitigated. The Hokkaido area was chosen because of its extremely favorable wind conditions and because wind today is the lowest cost IR by a significant margin. Its lower cost relative to solar is because in some locations wind blows many more hours per year than there are hours of good solar conditions.

The conclusion based on multiple studies using multiple methodologies and a wide variety of different assumptions is that energy systems without dispatchable energy sources are much more expensive with the cost rising dramatically as restrictions on greenhouse gas emissions are increased. A major challenge of a low carbon world is replacing fossil fuels as a dispatchable energy source. The existing low-carbon dispatchable energy source is nuclear energy. There are other potential options such as burning fossil fuels with carbon capture and sequestration.

Uncertainties

The large decreases in natural gas and oil prices driven by technology advances and rapid increase of IRs driven by policy changes and technology advances have occurred in less than 10 years. A shift to a low-carbon economy implies massive additional changes both in technologies and policies. Development and deployment of heat storage technologies has only begun where the technology limits and economics are not fully understood. The impact of other technologies such as demand management (time of day pricing of electricity, etc.) and electric cars (when recharge) depends as much on human behavior as

technology developments. Above all, political and geopolitical changes strongly impact energy futures. When we decide on technological and institutional options, decision must be based on how we foresee the future changes and what uncertainties are involved. This leads to the view that in this rapidly changing world we need frequent revisits to this issue of compatibility of IRs and nuclear and study optimum solution

Recommendations

- Technological and institutional innovation for both nuclear power and intermittent renewables is required to achieve a low-carbon grid without large increases in electricity costs.
- A fourth criterion for R&D on advanced nuclear reactors is necessary, economic dispatchable energy output to partly replace fossil fuels in that role. That capability is the enabling technology for the larger-scale economic use of intermittent renewables in electricity and heat markets in a low-carbon world, enabling storage and hybrid production of electricity and energy carriers.
- Multiple technologies need to be developed to provide dispatchable energy. We are only beginning the transition to a low-carbon system and thus the perspective herein is a snapshot in time of future projected nuclear technology options.
- *Electricity Prices* Excessive subsidies tend to distort electricity markets and, when remunerated, all clean generation technologies should be remunerated at the same price.
- *Electricity Capacity Markets* A more market-oriented and innovative approach to valuing reliable, low-carbon generation capacity could be to add an environmental dimension to capacity mechanisms. It would give an instrument for policy makers to ensure that a “cleaner” capacity and energy mix is achieved
- *Energy Storage* Given the important role of energy storage, subsidies could be applied, on a competitive basis, to storage capacity as well. Such subsidies should not specify technologies (electric storage or heat storage). The social requirement is low-cost storage.
- Further model development and analysis is recommended (1) to find what power systems result in the minimum burden to society by a combination of low-carbon dispatchable and non-dispatchable energy sources for smooth transition to a low carbon grid and (2) assist formulation of long-term research and development goals.
- Given the rapidly changing energy markets, we need frequent revisits to how we integrate nuclear and IRs to achieve optimum goals for society.

1. Introduction

Concerns about climate change will require a transition from fossil fuels to nuclear, wind, and solar. Because energy is about 8% of the gross national product of the world, it is essential to avoid large increases in energy costs that would significantly decrease human welfare. Fossil fuel electricity generating systems have relatively low capital costs and high operating costs—fuel. This characteristic enables economic variable electricity production that matches electricity demand because the cost of electricity from a fossil plant operating at part load is not that much different from a plant operating at full capacity.

Nuclear, wind and solar systems have high capital costs and low operating costs. If these electric generating assets are operated at half capacity, the cost of electricity is nearly doubled. Their high capital costs require full use of these systems. Wind and solar output depends upon location and local weather conditions—they do not provide dispatchable electricity or dispatchable energy for other uses and can't assure energy will be produced when needed. Today's nuclear systems can provide dispatchable electricity and heat but operating nuclear plants at low capacity factors is expensive. *The question is how do we create an economic power system with minimum burden to the society by a combination of low-carbon dispatchable and non-dispatchable energy sources, replacing the traditional role of fossil fuels, to fulfill the requirements for a safe, secure, affordable and environmentally acceptable energy source?* Independent of concerns about climate change, development of such nuclear systems would broaden the capabilities to economically meet global energy needs—a no-regrets nuclear energy strategy for the future.

To address these challenges researchers from the Massachusetts Institute of Technology, the University of Tokyo, the Tokyo Institute of Technology, the Institute of Applied Energy, the Japan Atomic Energy Authority and the Institute for Energy Economics Japan undertook a series of studies to address how to make this transition in the context of the Future of Nuclear Power. This included: (1) technologies to enable variable electricity to the grid while nuclear, wind, and solar plants operate at high capacity factors to minimize costs, (2) market structures (rules) to enable transition to a low-carbon system in deregulated electricity markets, (3) financial structures to enable building of facilities, and (4) electricity grid models to determine the impact on electricity prices of different advances in technology and different sets of rules.

The United States and Japan are among the largest market economies in the world with the capabilities to develop and deploy advanced technologies. They are logical partners for a transition to a low-carbon economy. However, there are also major differences. Japan has high energy costs and major energy concerns because most of its energy is imported. In contrast, with the development of fracking technologies for gas and oil recovery, energy costs in the United States have decreased and there are limiting concerns about energy security as the United States goes from importing to exporting natural gas. The contrasting near to mid-term energy environment provides a basis to examine these issues from different perspectives. There are also long-term differences including the large potential of biofuels in the United States but not in Japan.

In this chapter we set the stage to address these issue.

1.1. Global Energy Considerations

Abundant, affordable energy is the basis for modern societies. The United Nations ranks countries with a human development index [United Nations, 2015] that is a comparative measure of life expectancy, literacy, education and standards of living. There is a strong correlation (Fig. 1.1) between human development and per capita electricity consumption because energy is the common requirement for a safe and comfortable life and the manufacture of all goods (food, housing, clean water, etc.). The dividing line between the developed and undeveloped world is about 4000 kWh of annual electricity consumption per capita. To maintain standards of living in the developed world and to eliminate poverty worldwide requires massive quantities of energy and massive growth in energy resources.

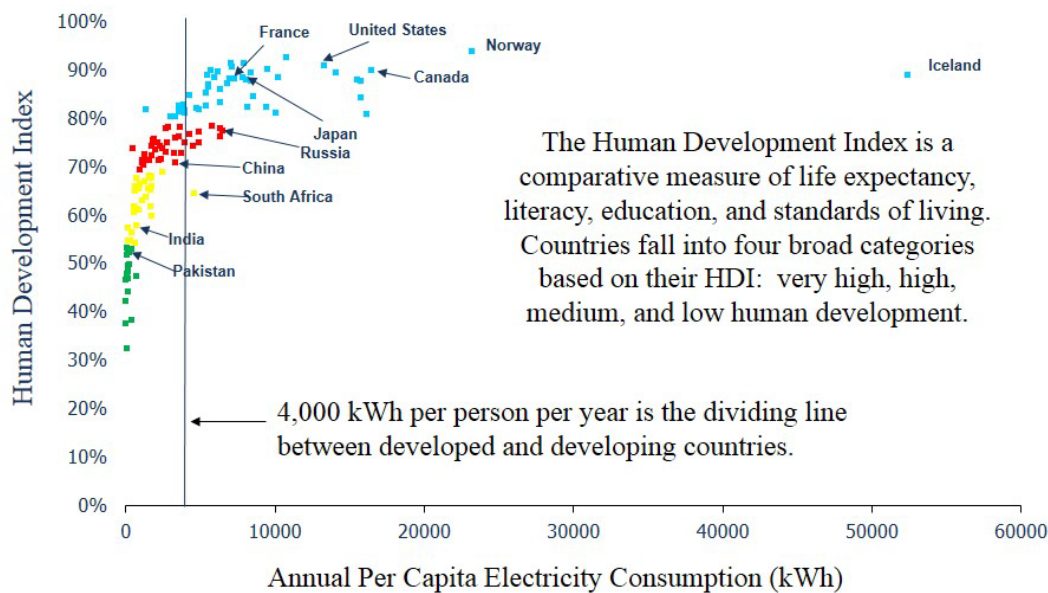

Fig. 1.1. Human Development Index versus Annual Per Capita Electricity Consumption

The cost of energy globally [Institute for Energy Research] and in the United States [U.S. Energy Information Agency, 2013] is about 8% of the gross national product. Because energy is such a large fraction of the global economy and the cost of living, minimizing the cost of energy is a social requirement. Doubling energy costs implies major reductions in global standards of living. There is a very large market for companies and countries that develop improved energy systems.

1.2. Changes in Energy Systems

Major changes are occurring in energy and electricity production worldwide that are causing a rethinking of how we produce and use energy.

1.2.1. Paradigm Shift to a Lower-Carbon World

There are two global trends that are reducing carbon emissions: (1) fracking to recover natural gas and oil and (2) low-carbon energy generating technologies. These trends are driven by economics and environmental goals—both clean air and reducing greenhouse gases to minimize climate change.

In the United States the largest energy trend of the last decade is the growing shift from coal to natural gas as the primary energy source--driven by a technical revolution in fracking. Since the 1980s improvements in natural gas fracking have increased recovery of natural gas from tight shale formations from about 1% to up to as high as 40% [King, 2012]. About a decade ago the technology had improved sufficiently to become economical in the United States. That resulted in dramatic increases in natural gas production, a factor of three drop in natural gas prices, and the substitution of natural gas for coal as the primary energy source. The economics continues to improve and its use in oil production appears to have placed a global limit on oil prices between \$50 and \$60 per barrel. This technology is now spreading to countries such as China. The predicted global energy consumption [U.S. EIA, 2016] through 2040 shows continued growth of oil and natural gas with natural gas passing coal globally and growing faster than any other energy source.

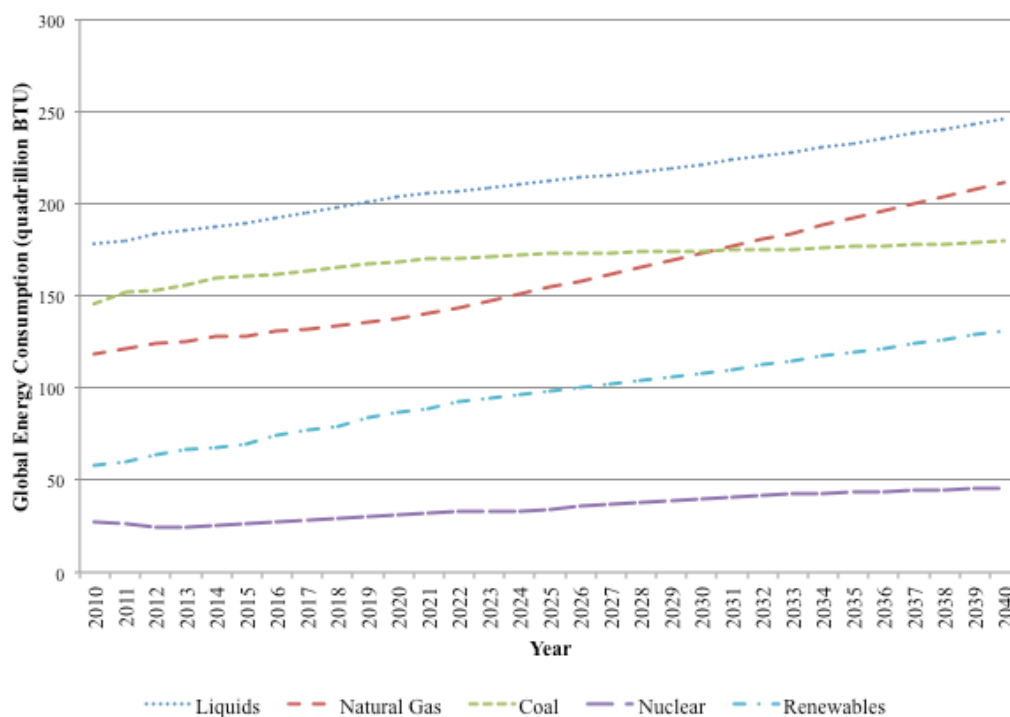

Fig. 1.2. Historical and Predicted Global Energy Consumption from the International Energy Outlook 2016 Report [EIA, 2016]

Natural gas (CH_4) has a much higher hydrogen to carbon ratio than coal; thus, burning natural gas has lower carbon dioxide emissions than burning coal per unit of heat. The other factor is the rapid advances in natural gas combined cycle (NGCC) plants for electricity production with heat-to-electricity efficiencies over 60%. These efficiencies are about 50% higher than coal to electricity plants. Consequently, the switch

to natural gas has dramatically driven down carbon dioxide emissions in the U.S., may reduce emissions in countries such as China that are beginning to use the technology and is reducing emissions elsewhere because of rapidly expanding global exports of natural gas. The dramatic decrease in natural gas prices also implies that the economic and political costs to transition to a zero-carbon society have increased—energy costs in a low-carbon world are likely to be significantly larger than expanded use of natural gas.

The second trend is the reduction in greenhouse gas emissions driven by concerns about climate change. This has resulted in many countries implementing policies to reduce greenhouse gas emissions by a combination of regulations and subsidies to low-carbon technologies, primarily renewables. In the public and policy discussions, the emphasis has been on low-carbon technologies but except in a few countries it has not been the major cause of reductions in greenhouse gas emissions—certainly not in the United States where lower natural gas prices are primarily responsible for lower greenhouse gas emissions. The major challenge with such policies has been costs. In Germany the increased tax burden from feed-in-tariffs (FITs) to support renewables have led to revisions including abolishment of FIT in Germany. In Japan the FIT burden will sooner or later approach the level of additional fuel costs replacing nuclear electricity (~ \$30 billion per year between 2011 and 2015). To avoid the political challenges of electricity price by taxation such as FIT or production tax credits (PTCs), new market strategies are being developed [MIT, 2016; UK, 2017] as will be discussed later.

There is one conclusion from the global experiences. If the economics are favorable, rapid changes in energy production can occur in twenty years. Large-scale natural gas fracking is a decade old in the United States and is rapidly transforming the energy system. The initial push for nuclear energy in the 1970s resulted in one-fifth of U.S. electricity generation and most of the electricity generation in France and Sweden from nuclear energy in about 20 years. Analysis and experience by companies such as Google [Koningstein, 2014] have come to similar conclusions. If the economics are unfavorable, the political and societal cost of switching to a higher-cost energy system are large with continuous changes in policy as costs become apparent to the public. The challenge for transitioning to a low-carbon economy is to find strategies that minimize costs while meeting the other social constraints.

1.2.2. Paradigm shift: Electric sector changes

Major shifts in technology and institutions are occurring in the electric sector that have a strong impact going forward.

Deregulation

Japan is in the process of deregulating the utilities. In the United States utilities are regulated by the 50 states with some federal regulation. About half the United States has deregulated electricity markets and the other half has regulated markets. In a regulated market, the utility has a monopoly for production and sales of electricity. The electricity prices are regulated by the government and the utility profits are determined based on how well the utility met goals defined by the government.

In a deregulated electricity markets the market determines electricity prices. If properly structured, markets will provide the lowest cost electricity as producers compete with each other. This economic

benefit is the basis for deregulating utilities. However, markets do not consider other social goals such as environment and energy security. To meet these goals governments define the market rules; thus, how these rules are written can determine what technologies are used for electricity generation. If there are goals such as a low-carbon electricity grid, innovation in market rules are as important as innovation in technology. Thus, this study examined options for market rules.

Changing Structure of the Electricity Grid

The structure of the electricity grid is changing (Fig. 1.3) because of technology that impacts the economics [MIT, 2016]. To gain the full economic benefits of these technical changes requires major changes in electricity market structure—innovation in institutions. The changes include:

- *Decentralized generation by the customer.* Historically large fossil and nuclear electricity generating plants provided the lowest cost electricity; thus, electricity was generated in large plants and distributed to customers. There were exceptions such as large industrial facilities with combined electricity and heat production facilities that sold electricity to the grid—but these are technically sophisticated industrial customers. The advent of technologies such as photovoltaics (PV) creates the option of decentralize generation by large numbers of customers [MIT, 2015] with electricity flows in all directions on the grid (Fig. 1.3) with many customers that are also producers. Solar is deployed in both as a central station and decentralized electricity generating technology. Wind is almost always deployed as a centralized electricity generating technology.
- *Non Dispatchable Electricity Generation.* Fossil and nuclear electricity generating systems are dispatchable—the output can be varied to meet customer demand. Most hydroelectricity is dispatchable. The exception is run-of-the-river hydro where there is no storage reservoir and output depends upon river flow. Wind and solar are not dispatchable; output depends upon solar and wind conditions. If these are significant contributors to the electricity system, storage systems are required to match production with demand. The costs of those storage systems are part of the cost of these renewables.
- *Demand-side Management.* Historically utilities produced sufficient electricity to meet demand. This resulted in building expensive electricity generating plants that that operated a few tens to hundreds of hours to meet peak demand. Demand-side management refers to reducing the demand at selected times to reduce the need to build electricity generating capacity that operates at low capacity factors. Demand side management has been used for decades where large industrial customers agreed to reduce electricity demand at the utility request in exchange for lower electricity rates. The development of electronic electricity meters, controllers and the internet technically enable extending demand side management to small customers such as households to control when appliances such as hot water consume electricity or recharge batteries. The implementation of demand-side management to a larger class of customers requires changes in electricity market rules that provides incentives for the customer to use this technology. It has the potential to significantly shift electricity demand by a few hours [MIT, 2016].

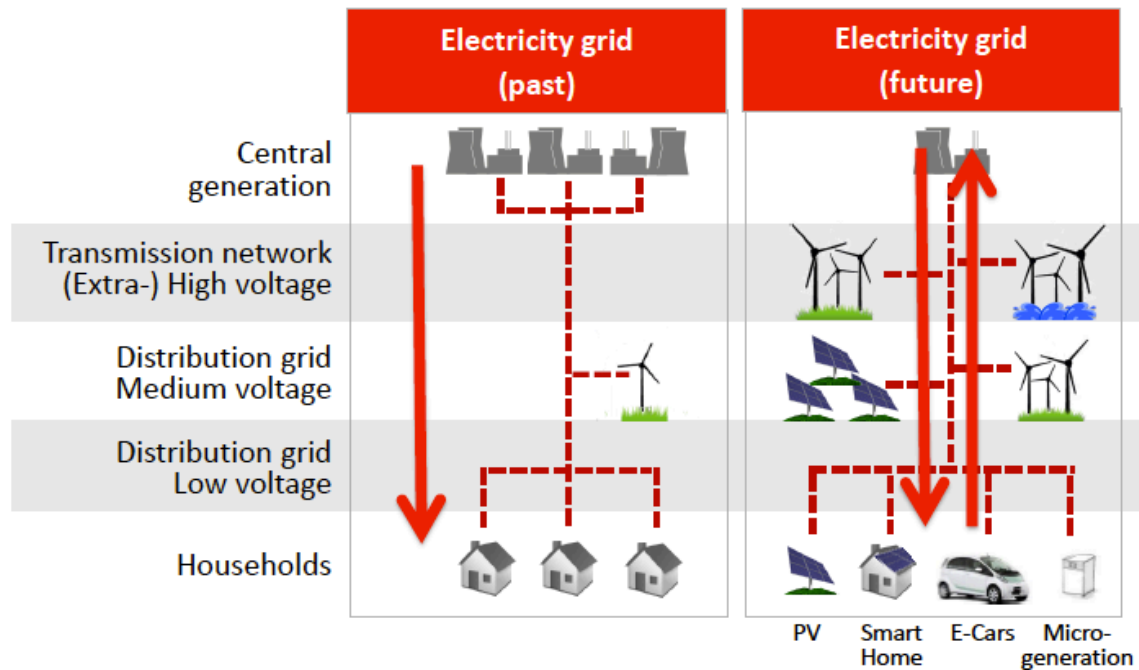

Fig. 1.3. Changing Structure of the Electricity Grid [J. Specht, E.ON, August 2014]

Utility Sector Changes in the United States and Japan

In the United States the electricity sector experienced several major shifts. First, the development of shale gas has created an abundance of cheap natural gas. Natural gas spot prices fell from \$8.9 / MMBtu in 2008 to \$2.6 / MMBtu in 2015 at the Henry Hub. The Henry Hub is a distribution hub on the natural gas pipeline system in Erath, Louisiana. Due to its importance, it lends its name to the pricing point for natural gas futures contracts traded on the New York Mercantile Exchange (NYMEX) and the OTC swaps traded on Intercontinental Exchange (ICE). Electricity generated from natural gas has become cheaper than electricity generated from coal in most regions, as illustrated in Figure 1.4. As a consequence, natural gas is displacing coal as the most important fuel for the production of electricity in the United States with large decreases in the wholesale price of electricity.

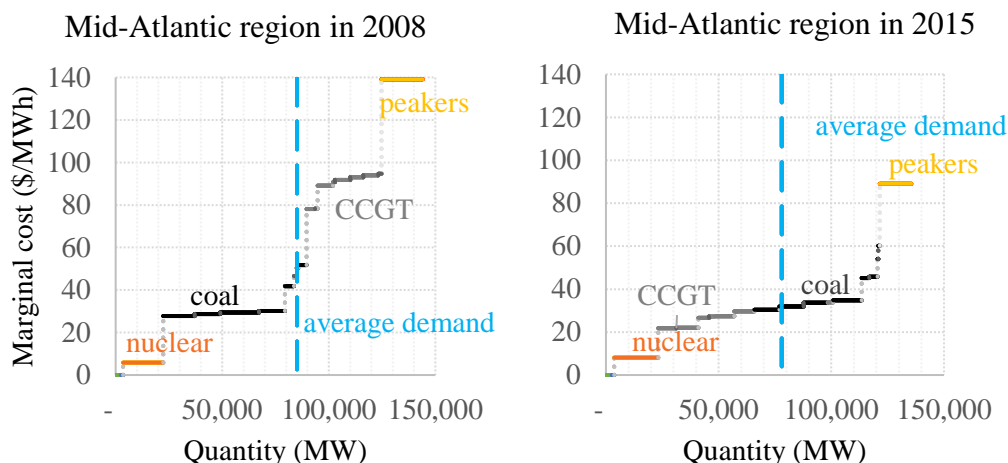

Fig. 1.4. In the 2008 electricity cost supply stack (left), natural-gas combined-cycle gas turbines (CCGT) units are more expensive to dispatch than coal-fired units. In 2015 (right), the situation has been reversed and coal is displaced by CCGT.

Second, electricity demand growth stalled. Third, we observed a rapid growth of renewable (wind and solar PV) capacity installation. In the Midwest region for instance, wind capacity installed grew from 6.4 GW in 2008 to 19.3 GW in 2015, accounting to 11% of the total installed capacity. The development of renewables was driven primarily by state and federal subsidies since renewables are still uneconomical in most locations, despite a spectacular decrease in capital costs over the past 10 years (Lazard, 2016). Nevertheless, the US still owes 80% of carbon-free electricity to nuclear and hydro power.

These changes in supply and demand led to a significant decrease in electricity prices. Between 2008 and 2015, electricity prices fell by 40 to 50% in the US hubs. In locations with high concentration of renewables and limited transmission capabilities, the price decrease was even greater. Commercial nuclear reactors have consequently seen decreases in their revenue. Tens of gigawatts of nuclear capacity have become unprofitable and are at risk of retiring prematurely in the U.S. [Haratyk, 2017].

The situation in Japan is very different. Japan so far has not benefited from cheap shale gas. There is an increasing burden of FIT to renewables (\$20 billion as of FY 2016). Furthermore, utilities are paying ~\$30 billion/year for natural gas and oil for lost electricity production from nuclear units in 2011 to 2015, though this amount is reduced recently due to three changes (restarting nuclear units, cheap fossil price and currency exchange rate). As a consequence, international comparison of electricity tariff for industry and residential consumers in the last 20 years [CRIEPI (Central Research Institute for Electric Power Companies), 2017] shows that Japan had stable or reduced tariff until 2011 amid other advanced countries with rising tariff. Nevertheless, this trend has changed recently due to a) increased import of gas and oil to replace nuclear power generation (30B\$/year), and b) feed-in-tariffs (FIT) for renewables (currently amounted to 18B\$/year). As a consequence, the rise in tariff is around 19% for residential and 29% for industrial users according to statistics for FY2015 (till the end of March 2016) [METI (Ministry of Economics, Trade and Industry), 2015].

In terms of renewable energy policies, there is a difference between the United States and Japan. In Japan the cost of renewables subsidies are paid for by the electricity customer—the electricity customer

sees the full price of energy policies. Supported by the FIT, the installed capacity of Japanese solar power exceeded installed and available (when licensed under new post-Fukushima regulation) nuclear capacity by December 2016; i.e., solar 43Gwe, nuclear 41.5Gwe. If all the FIT-certified (but not installed yet) solar capacity is installed, solar will add up to 80GWe. In the United States federal subsidies are in the form of production tax credits paid for by the taxpayer while state government subsidies, such as renewable portfolio standards and net metering, are paid for by the electricity customer.

As a consequence of these paradigm shifts, although nuclear power generation has unique features for sustainable development in terms of long-term availability of resources, stable price, clean air, and supply security, its future outlook in the United States and Japan is not promising in the near-term including the prospect of new nuclear build. This naturally raise a concern if a shift to low carbon economy and sustainable development is possible without nuclear power.

1.2.3. Paradigm Shift: Shift of energy to non-OECD and East

According to IAEA PRIS (Power Reactor Information System) [IAEA], around 80% of 450 operating reactors in the world belongs to OECD countries, whereas less than 70% of 60 plants currently under construction belongs to non-OECD countries. Regional distribution of new nuclear build shows 60% in East (including Middle and South). Clearly there is a shift, as far as new build is concerned, of a) from OECD to non-OECD, and b) from West to East. Also, given difficulty of financing capital-intensive nuclear projects, there is a new financing scheme among new nuclear builds (be it in planning stage or construction phase) that depends on government-to-government deal in support of non-OECD countries, which factor is also seen behind the increase of new builds in non-OECD countries. Given the recent increased cost of new nuclear build globally [“Nuclear New Build: Insights into Financing and Project Management”, OECD/NEA, 2015] and increased share of intermittent renewables with low electricity cost by subsidies, in some new entrants, competitiveness of nuclear electricity is becoming an issue even before the start of construction.

1.3. Major Findings of Phase I Study

Our Phase I study *Compatibility of Nuclear and Renewables with Grid Stability, Economics, and Deregulation* [Forsberg 2016] did an initial examination of the challenges of integrating nuclear and renewables. The major conclusions of the White paper (Appendix A) include:

- *Need to understand the challenges of simultaneously liberalizing electricity markets and integrating intermittent renewables on the grid.* In a deregulated markets increased deployment of wind or solar drives down electricity prices at times of high wind or solar output reflecting its low market value at these times. The collapse of revenue limits further expansion of these energy sources even if there are decreases in the capital costs of these technologies. This market effect hurts the economics of traditional base-load nuclear power plants that continue to sell electricity at times of low prices. It helps the economics of low-capital-cost high-operating cost fossil plants

that shut down at times of low electricity prices and operate only when electricity prices are high.

- *Need methods to productively use excess electricity generated in low-carbon grids to limit energy costs to society.* The collapse in electricity prices if large-scale installation of wind or solar reflects wasted resources—high capital cost equipment that is only partly utilized. To maximize economic benefit, these resources must be used near their full capacity.
- *Need for technology and institutional innovation.* Our technologies and institutional structures have been designed for a fossil-fuel energy system that is characterized by plants with low capital cost and high operating costs (fuel). The low-carbon options (nuclear, wind and solar) are characterized by high capital costs and low operating costs. This requires new innovative technologies that match the future requirements and associated institutional innovations.

The results of that White paper led to this report with conclusions and strategies to develop an economic low-carbon electricity grid.

1.4. Requirements

When considering energy policy including strategy for future generation portfolio, desirable energy is expected to be reliable (stable in terms of shield from political interruption and fluctuation of price), affordable and clean (in the context of air/water pollution and small footprint in Green House Gas (GHG) emission), though priority will vary depending on country specifics. It also goes without saying that safety must be assured. Japan had set 3E+S as a guiding principle for energy strategy (Energy security, Economic efficiency, Environmental protection and Safety). Supply security has different elements; a) avoiding risk of interruption of supply by political reason, and b) shielding from fuel price volatility. It is an important issue for a country like Japan which depends heavily on import, especially fossil, but is not in the US.

1.5. Report Structure

Energy systems (Fig. 1.5) involve complex interactions between technology, institutional structures, and finance. Thus, this report addresses all of these aspects.

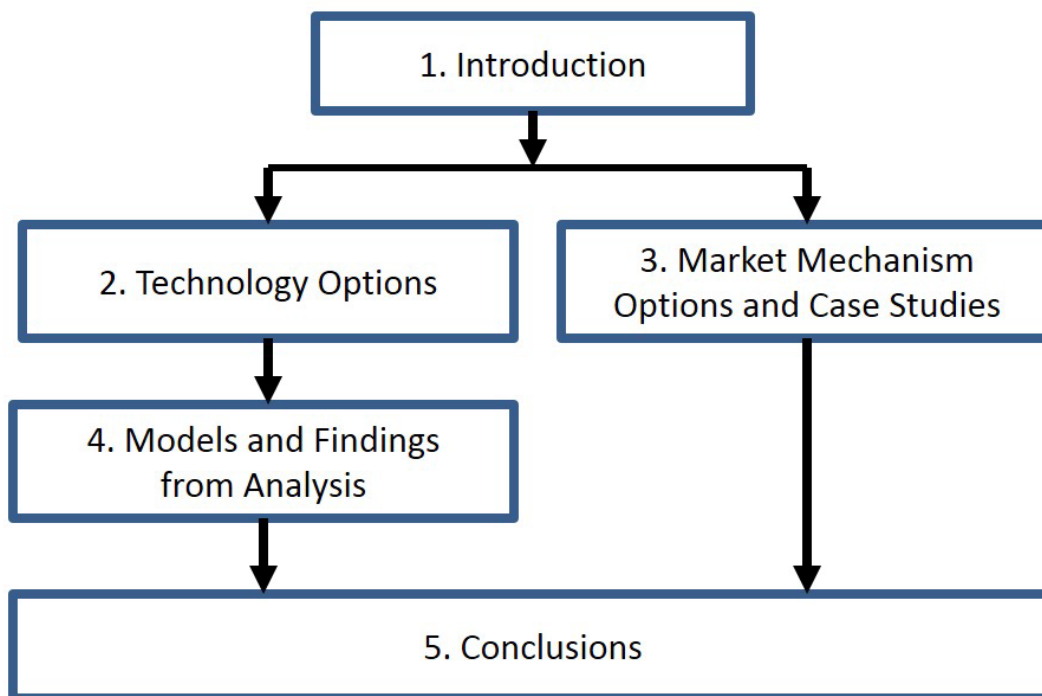

Fig. 1.5. Outline of the Report Structure

Chapter 2 describes the changes in the electricity markets and future technology options to enable nuclear power to replace fossil fuels in their role of providing dispatchable electricity to the grid and industry. Historically nuclear power has been used to provide base-load electricity. In a low-carbon world, there is the need for low-cost dispatchable electricity where the primary options are nuclear with thermal energy storage systems and renewables with work (electricity) storage systems—each with very different characteristics.

Chapter 3 discusses options for institutional innovations—what is required for electricity market rules to enable transition to a low-carbon grid.

Chapter 4 discusses the results of energy system models that can be used to understand the cost and other impacts of different technology and policy options.

Chapter 5 provides the major conclusions.

References

CRIEPI (Central Research Institute of Electricity Power Companies), 2017. “International comparison of electricity tariff”, CRIEPI report Y11013 (2012.4), and its update Y16501 (2017.1) (in Japanese)

Forsberg, C. W., et al. 2016. “Compatibility of Nuclear and Renewables with Grid Stability, Economics and Deregulation”, Joint MIT-Japan White Paper.

G, Haratyk, 2017. “Early Nuclear Retirements in Deregulated U.S. Markets: Causes, Consequences and Policy Options”, *Energy Policy*, 110, 150-166, <http://dx.doi.org/10.1016/j.enpol.2017.08.023>.

Institute for Energy Research, <http://instituteforenergyresearch.org/analysis/a-primer-on-energy-and-the-economy-energys-large-share-of-the-economy-requires-caution-in-determining-policies-that-affect-it/>

IAEA (International Atomic Energy Agency), PRIS; <https://www.iaea.org/pris/>

King, G. E., 2012, *Hydraulic Fracturing 101: What Every Representative, Environmentalist, Regulator, Reporter, Investor, University Researcher, Neighbor and Engineer Should Know About Estimating Frac Risk and Improving Frac Performance in Unconventional Gas and Oil Wells*. Society of Petroleum Engineers. doi:10.2118/152596-MS

Koningstein, R. and D. Fork, “What It Would Really Take to Reverse Climate Change,” *IEEE Spectrum*, November 18, 2014

Lazard, 2016. “Lazard’s Levelized Cost of Energy Analysis – Version 10.0”, Dec 2016.

Massachusetts Institute of Technology, 2015, *The Future of Solar Energy*

Massachusetts Institute of Technology, 2016. *The Future of the Utility*,

METI (Ministry of Economics, Trade and Industry), 2015. “Electricity tariff”, submitted to METI committee on basic energy policy, 2015.11.18 (in Japanese).

“Nuclear New Build: Insights into Financing and Project Management”, OECD/NEA, 2015

United Kingdom Upper House, 2017, *The Price of Power: Reforming the Electricity Market*, February

United Nations, 2015. Human Development Index – 2015 data United Nations; Annual Per Capita Electricity Consumption (kWh) - 2011 data World Bank, Updated: 7/15

United States Energy Information Agency, 2013.
https://www.eia.gov/totalenergy/data/annual/pdf/sec1_13.pdf

United States Energy Information Agency, 2016. "International Energy Outlook 2016," U.S. Department of Energy, DOE/EIA-0484(2016).

2. Technology Options for Nuclear Energy Replacing Fossil Fuels

We describe in this chapter the technical options for using nuclear energy as a dispatchable energy source to replace fossil fuels in that role in a low-carbon world. The addition of wind and solar increases the need for dispatchable energy; thus, the large-scale deployment of wind and solar depends upon developing economic large-scale low-carbon dispatchable energy sources. Some technical options for dispatchable nuclear energy can be deployed today but others require significant research and development.

Historically almost all commercial nuclear reactors have been designed and operated for one purpose: base-load electricity production. A few commercial reactors produce electricity and steam for industry or district heating. A few commercial reactors produce variable electricity. This historical use of nuclear energy is a consequence of the high-capital-cost low-operating-cost characteristics of nuclear energy and the low-capital-cost high-operating-cost characteristics of fossil fuels. Under these conditions total costs are minimized by operating the nuclear plants at full capacity with the fossil plants providing variable energy output as needed by society. Nuclear energy was designed to fit within a larger fossil fuel world as would be expected of any new energy technology in a world energy system dominated by fossil fuels. In a low-carbon world nuclear must meet new requirements that are discussed in Section 2.1.

The supply of wind and solar energy is intermittent and non-dispatchable; thus, a wide variety options are being investigated to address the mismatch between supply and demand created by an intermittent energy supply. This includes the use of dispatchable “flexible renewables” (biomass gas and small hydro) and demand management that moves energy demand to when electricity prices are low and excess electricity is available. Demand management is a large set of options including (1) industry (such as timing use of metal heat treating furnaces), (2) commercial enterprises (varying heating and cooling loads in buildings) and (3) consumers (from controlling operation of hot water heaters to when to charge electric cars).

Nuclear, wind and solar have different technical characteristics. Wind and solar are non-dispatchable—their output depends upon solar and wind conditions. Nuclear energy is dispatchable. Equally important, wind and photovoltaics (PV) produce electricity that naturally couples to electricity (work) storage technologies such as pumped hydro, batteries and similar technologies. Nuclear energy produces heat that couples to heat storage technologies—creating the option of nuclear reactors that operate at full capacity using thermal storage to provide variable output—as discussed in Section 2.2.

Electricity is only part of the energy system. In a low-carbon world substitutes for fossil fuels for the other energy sectors are required. The options including hydrogen, ammonia, biofuels and synthetic hydrocarbons that are discussed in Section 2.3. Massive quantities of heat and electricity will be required to produce these energy carriers.

Last, the changes in the requirements may impose changes on reactor types and reactor development strategies, as discussed in section 2.4.

2.1. The Challenge

The combination of fossil and nuclear plants results in low-cost electricity. Nuclear plants have high capital costs but low marginal operating costs, thus base-load operation is their economic mode of operation. Fossil plants (particularly gas turbines) have low capital costs and high operating costs (fuel); thus, the cost of electricity does not increase rapidly if the power plant is operated at part load. This favors the use of fossil plants to produce dispatchable electricity to match variable demand. The same is true for production of heat for industry. In a low-carbon world the question is what replaces fossil fuels for variable energy production?

Like nuclear plants, solar and wind have high capital costs and low marginal operating costs. If a solar or wind system operates only half the time when there is high solar or wind input, their cost of electricity is doubled. This favors operating at full capacity but large-scale deployment of wind or solar results in excess electricity production at times of high wind or solar output—decreasing the demand for base-load electricity and increasing the demand for dispatchable electricity for times of low wind or solar output.

The effects of these changes can be seen in electricity markets. Markets are used to minimize total costs to society of energy. In most deregulated electricity markets, electricity generators bid a day ahead on the price that they are willing to sell electricity into the market—typically for each hour of the day. The grid operator accepts electricity bids up to the expected electricity demand for each hour. The bid (\$/MWh) with the highest electricity price that is accepted sets the price for that hour and everyone who bids below that price gets this same price for electricity sold during that hour. Most markets have a variety of other mechanisms to assure reliable electricity and remain within the constraints of the electricity grid.

Different electricity generating technologies have different capital and operating costs. The operating plant with the most expensive marginal costs sets the electricity prices for that hour. Historically most electricity has been generated using fossil fuels; thus, the price set for each hour was from the fossil fuel plant operating at that hour with the highest marginal operating costs. Nuclear plants with low operating costs were base-load plants because their operating cost was always less than the operating costs of fossil fuel plants.

The addition of large quantities of wind or solar changes the electricity market. In a competitive market they bid zero dollars per megawatt hour—their marginal operating costs. The Massachusetts Institute of Technology (MIT) *Future of Solar Energy* [2015] study provides an examination of the solar option and the challenge of moving from an electricity grid dominated by fossil fuel generation to a grid with significant solar capacity.

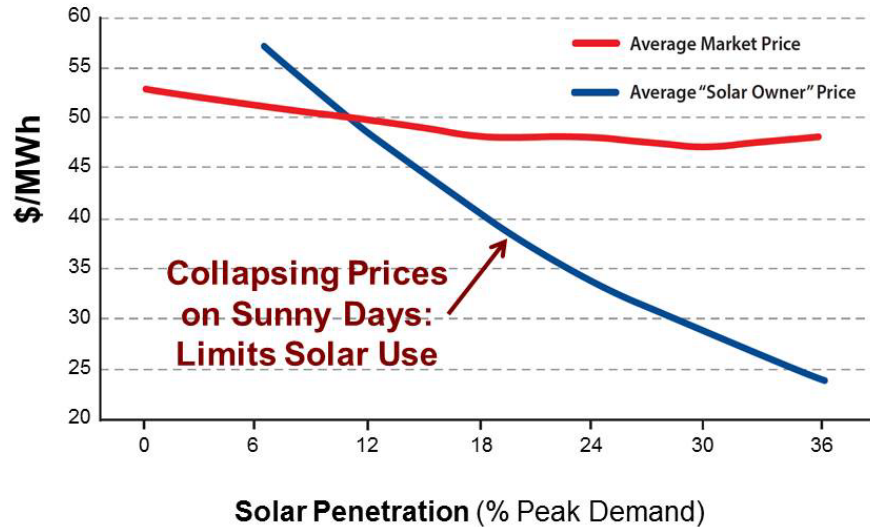

Fig. 2.1. Solar PV Market Income and Average Wholesale Electricity Prices versus Solar PV Penetration [MIT, 2015]

Figure 2.1 shows market income per unit of energy for solar plants as added solar plants are built. The average price of electricity received for the first few solar plants that are built is above the average yearly electricity price because the electricity is produced in the middle of the day when there is high demand and the prices are high. As more solar plants are built, electricity prices at times of high solar output decrease; thus, solar revenue collapses with large-scale solar deployment. This limits unsubsidized solar capacity to a relatively small fraction of total electricity production even if there are very large decreases in solar capital costs. Electricity price collapse at times of high solar input hurts not just the economics of solar but also wind and nuclear (Appendix A).

At the same time there are only small changes in the average price of electricity. When solar collapses electricity prices at times of high solar input, it reduces revenue for all power generators. Other power plants are required to provide electricity at times of low solar output—but these plants operate for fewer hours per year. Investors will not build new power plants to meet this need unless the price of electricity increases at times of low solar output to cover the costs of a power plant that operates only part of the time. Consequently the average costs of electricity show only limited decreases in prices. This favors the use of fossil fuel plants with low-capital-cost and higher-operating-cost to provide the required variable electricity. With existing technologies in deregulated markets the addition of solar and wind locks in the use of fossil fuels—the opposite of the goal of a low-carbon economy. It also hurts the economics of nuclear and geothermal, dispatchable low-carbon technologies.

Figure 2.2 shows a simulation [Haratyk 2017b] of the Tokyo Electric grid with the addition of solar. This assumes half the nuclear capacity is restarted. By the time solar provides 25% of the total electricity (50 GWe solar), the average revenue for solar plants has dropped by 50%. Large-scale solar deployment requires massive subsidies, as well as decreasing revenue for nuclear plants at times of high solar output, unless some productive use is found for the electricity generated at these times.

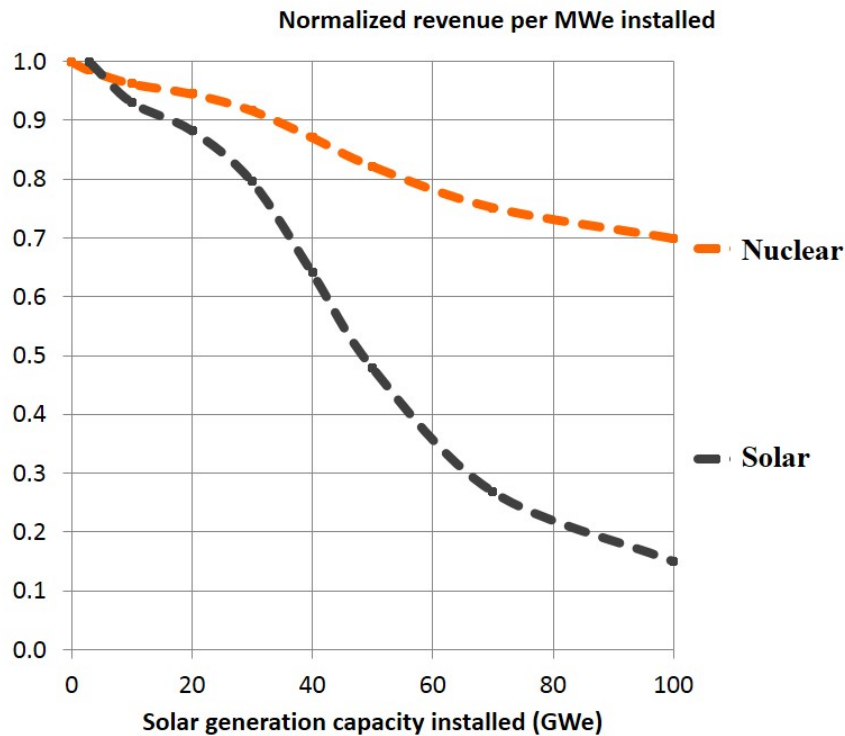

Fig. 2.2. Projected Normalized Revenue for Solar and Nuclear for Tokyo Electric as Solar Generating Capacity is Increased

The same effect occurs with wind. Recent studies have quantified this effect in the European market [Hirth, 2013; Hirth, 2015]. If wind grows from providing 0% to 30% of all electricity, the average yearly price for wind electricity in the market would drop from 73 €/MWe (first wind farm) to 18€/MWe (30% of all electricity generated). There would be 1000 hours per year when wind could provide the total electricity demand, the price of electricity would be near zero, and 28% of all wind energy would be sold in the market for prices near zero.

To use a real example, Fig. 2.3 shows wholesale prices for electricity in western Iowa in the United States, a state with a large installed wind capacity. One can see the impact of added renewables on electricity prices including negative prices enabled by wind subsidies on days of high wind conditions. Unless there are new technologies, the large-scale use of wind and solar will require large public subsidies because they collapse the price of electricity at times of maximum production.

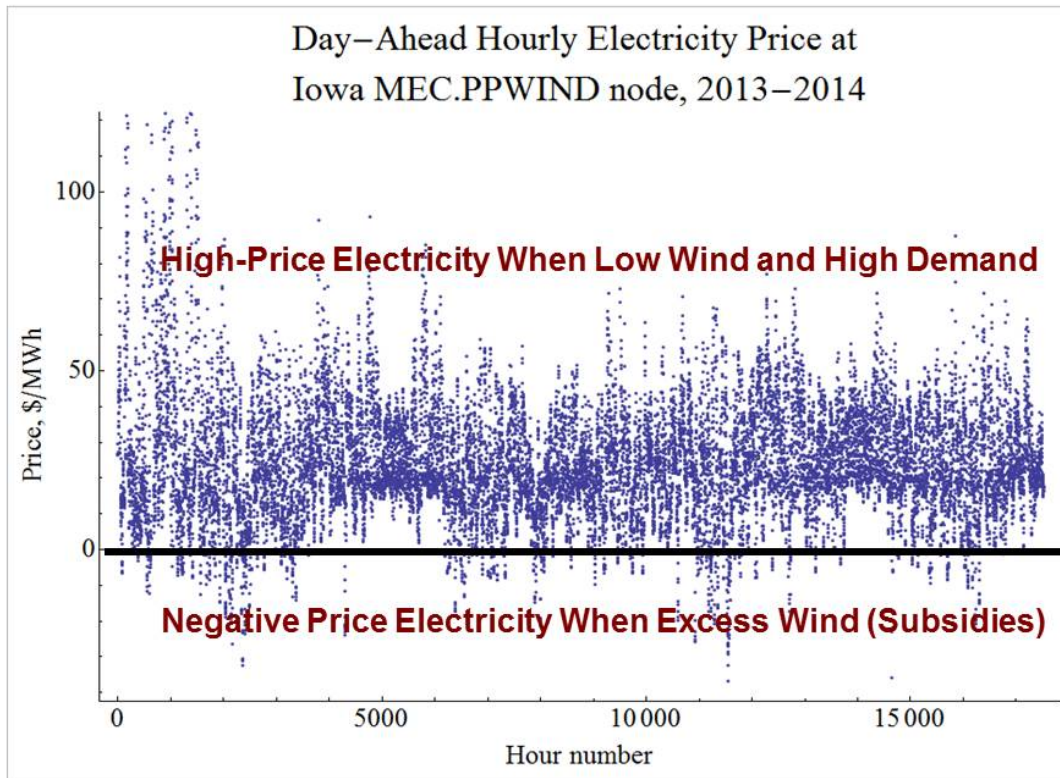

Fig. 2.3. Hourly Wholesale Electricity Prices in Western Iowa over Two Years

We modeled for the Midwest Independent System Operator (MISO) in the United States the impact of adding wind to the market price for electricity (Fig. 2.4). As with solar in the Tokyo electricity grid, increased wind penetration results in large decreases in wholesale electricity prices. Such large-scale use of wind would require large public subsidies since the revenue from the sale of electricity would be insufficient to pay for the wind farms. The impact on nuclear plant revenue is also shown.

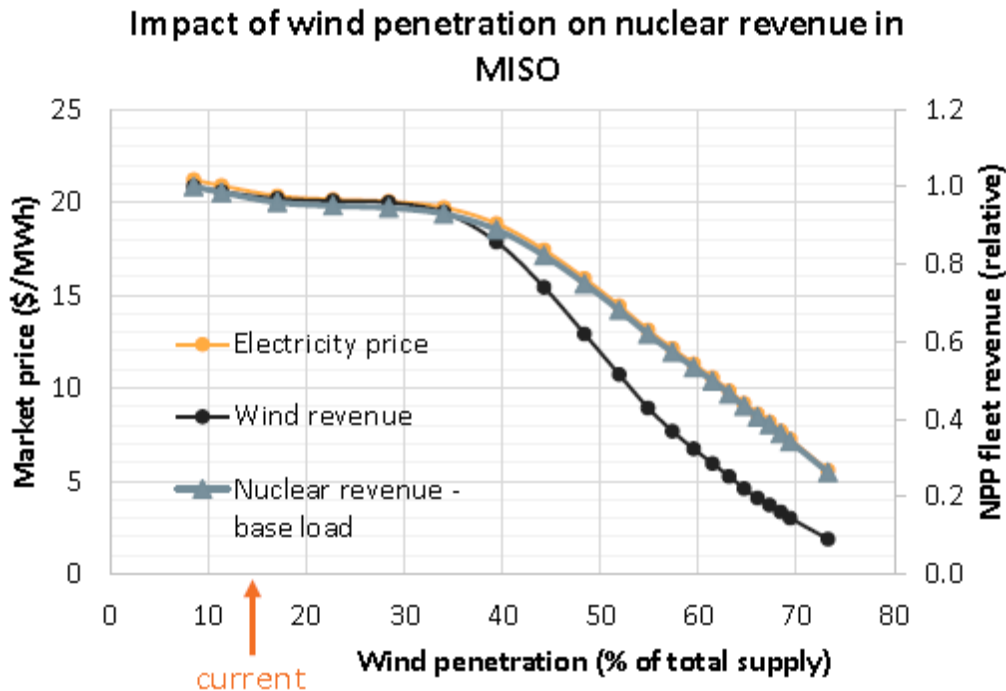

Fig. 2.4. Impact of Wind Penetration into the MISO Market on Wind and Nuclear Power Plant Revenue

It is a general characteristics of all generating technologies that they have decreasing marginal value with added installed capacity with solar showing the most rapid decline with market penetration followed by wind and then nuclear [Forsberg, 2013; Bistline, 2017, Mills, 2012]. Solar has the most rapid decline in marginal value as add capacity because most of the electricity is produced in the middle of the day over a few hours. If one continues to build capacity with any of these technologies, the value of each additional unit of power generation capacity goes down—ultimately to zero. The cross over to zero marginal value depends upon the particular electricity demand curve [Bistline, 2017].

The above considerations indicate the need to develop alternative nuclear power systems that can replace fossil fuels and their ability to produce variable economic energy on demand. We examine in this chapter the low-carbon nuclear energy options starting with the production of dispatchable electricity and then production of other storable forms of energy (hydrogen, ammonia, etc.) that could partly replace fossil fuels for applications such as transportation.

2.2. Dispatchable Electricity with Base-Load Reactors and Heat Storage

There are two storage options to match energy demand with energy production using the full production capacity of nuclear, wind, and solar: work and heat. The science of thermodynamics shows that work and heat are fundamentally different—the basis of much of power engineering that is about converting heat into electricity. Photovoltaic solar and wind produce electricity, a type of work. These technologies logically couple to work (electricity) storage devices include pumped hydro (gravitational

energy), batteries (chemical energy) and flywheels (kinetic energy). Nuclear and solar thermal systems produce heat that is then converted into electricity (work). There is the option of storing heat and then converting it to electricity to meet variable electricity demand.

There are large economic incentives to store heat rather than work. Thermal energy storage is potentially one to two orders of magnitude less expensive than storing work. The U.S. Department of Energy 2020 goal for thermal storage associated with solar power towers is \$15/kWhth [Office of Energy Efficiency and Renewable Energy 2017, Mehos et al., 2016]—a factor of ten lower than the goals for storing electricity in batteries. Recent studies (Schmidt, 2017) of eleven electrical storage technologies (pumped hydro, lead acid, lithium ion, nickel-metal hydride, sodium sulfur, vanadium redox flow, electrolysis, fuel cells) based on experience rates (learning curves) concluded capital costs are on a trajectory toward \$340/kWh plus or minus \$60/kWh once one TWh of capacity of each technology is installed. For technologies such as lithium ion batteries, several variants were included. These large differences in storage costs imply large differences in electricity rates in systems that require energy storage devices. Coupling low-cost heat storage to large solar power systems has become normal business practice to minimize selling of electricity at times of low prices. In contrast, coupling PV to storage is not generally done because of the high costs of electricity storage.

The large cost difference between electricity storage and thermal storage creates large economic incentives to couple nuclear plants to heat storage to reduce costs of energy storage. We examine four classes of heat storage technologies. In each case the reactor operates at full capacity with variable output.

- *Store Heat from Reactors with Steam Power Cycles.* Heat is sent from the reactor to storage for later conversion into electricity, another product, or use by industry. The power plant sends variable electricity to the grid.
- *Electricity Converted to High-Temperature Stored Heat.* Electricity at times of excess capacity is converted to high-temperature stored heat that can be used by industry or in nuclear power plant power cycles to produce additional peak electricity at times of high electricity demand. This technology transfers energy from the electricity sector to the industrial sector and potentially creating a minimum price for electricity (limits price collapse)
- *Store Heat from Reactors with Brayton Power Cycles.* Advanced Brayton cycles can include heat storage for variable electricity to the grid. Some of the power cycle options allow the power plant to buy or sell electricity depending upon market needs.
- *Store Heat in the Reactor Core.* One class of nuclear reactors, high-temperature gas-cooled reactors (HTGRs), has reactor cores with extremely large heat capacities. There is the option for variable electricity with constant reactor heat production by using the reactor core as a heat storage system.

Only with the need for low-carbon energy sources and/or the deployment of non-dispatchable wind and solar have there been incentives to develop heat storage technologies coupled to nuclear plants—those incentives have only existed for several years. Consequently, none of these technologies has yet been deployed. Some of these technologies are close to deployment but others require significant R&D.

2.2.1 Heat Storage Coupled to Reactors with Steam Power Cycles

Heat storage can be coupled to any type of reactor. However, heat storage options have only been explored in any detail for coupling to light-water reactors (LWRs) with steam power cycles—the current technology. We describe options that are under development to store heat from reactors at times of low electricity prices to produce added electricity when needed while the reactor operates at base-load to minimize total energy costs to society. Most of these options can also store heat for later use by industry. Details can be found in Appendix D and a recent workshop proceedings on heat storage and LWRs (Forsberg, July 2017a).

For most heat storage options coupled to a nuclear reactor, the reactor operates at base-load. This is its most economical mode of operation. At times of low electricity prices the minimum amount of steam is sent to the turbine to keep it on line while most of the steam is sent to the heat storage system. By keeping the steam turbine and generator on line, the electricity output to the grid can be quickly returned to full power when needed by sending all steam through the turbine. Heat storage systems have three subsystems.

- *Heat Input.* Steam is taken from the turbine hall and transported to the storage systems. In some storage systems such as steam accumulators the steam goes directly into the storage system. In other cases the steam is used to heat a secondary storage fluid using a heat exchanger with the condensate water returned to the reactor. The cost of this system is measured in \$/kWt capacity.
- *Heat Storage.* Heat can be stored in many forms (hot pressurized water, secondary heat storage liquid or solid, pebble bed, etc.). The cost storage is measured in dollars per unit of heat stored (\$/kWh).
- *Conversion of Heat to Electricity.* There are two options. The first option is a stand-alone power cycle. The second option is to send the heat back to the main turbine associated with the reactor. Where viable, the second option has two advantages: (1) the main turbine is always running so fast response and (2) the incremental cost of a somewhat larger turbine-generator is much less than a stand-alone power system. In LWRs about a third of the steam is used preheat feed water. Steam from storage may be sent to the turbines (high, medium or low pressure) or used to preheat feed water.

Six classes of heat storage systems that can couple to a nuclear power plant are have been identified. Several of these could be deployed in the near term but other options require significant research and development.

Steam Accumulators. A steam accumulator is a pressure vessel nearly full of water that is heated to its saturation temperature by steam injection. The heat is stored as high-temperature high-pressure water. When steam is needed, valves open and some of the water is flashed to steam that is sent to a turbine producing electricity while the remainder of the water decreases in temperature.

Steam accumulators have been used for energy storage and pressure buffers in steam plants for over a

century and are coupled to several solar thermal plants as a mechanism of heat storage to enable variable electricity production. The earliest large-scale steam accumulator for variable electricity production was built in Berlin in the 1920s, charged using steam from a fossil power plant, and had a peak output of 50 MWe. Steam accumulators are capable of rapid charge and discharge cycles. While there have been only limited studies of steam accumulators coupled to nuclear reactors, the technology could be deployed today. The cost of the high-pressure storage tanks probably limits these systems for hourly to daily energy storage where there are many cycles of storage per year to cover capital costs.

Sensible Heat Fluid Systems. Sensible heat storage involves heating a second fluid with steam, storing that second hot fluid at atmospheric pressure, and using that fluid later to provide the heat to produce steam to then produce electricity. This heat storage technology is used with solar thermal power systems at temperatures near those of LWRs.

A range of fluids have been used in these systems. Studies at North Carolina State University and Westinghouse indicate that heat transfer oils are likely to be the preferred heat transfer fluid when coupling sensible heat storage to an LWR.

There are two physical storage configurations: two-tank and thermocline systems. In a two-tank system, one tank will hold cold fluid and one will hold hot fluid, with the ratio of fill levels in the tanks indicating the state of charge. In a thermocline system during charging, hot fluid is injected at the top of the tank while cold fluid is removed from the bottom. To remove heat, the process is reversed. In both cases, one heat exchanger is used to heat the fluid with steam during charging and one is used to cool the fluid to produce steam or hot water when discharging. Solar thermal two-tank sensible heat storage has been demonstrated at the 100 MWh scale, and the thermocline type has been demonstrated at the 1 MWh scale.

Westinghouse has begun development of a sensible heat storage system for LWRs (Fig. 2.5) where each storage module stores sufficient heat to generate a MWh of electricity. Steam heats low-pressure oil that then transfers its heat to a heat storage module. In this system the storage tanks have vertical concrete plates as the primary heat storage media rather than oil because concrete is a much less expensive heat storage media and can be produced locally. The hot oil flows through narrow channels between slabs of concrete. To recover the heat, the direction of oil flow is reversed. The hot oil would be used to generate steam that is sent to (1) the main reactor turbine, (2) a partial replacement for steam to feed-water heaters, or (3) a separate power system. Alternatively it could be used to produce hot water for local needs.

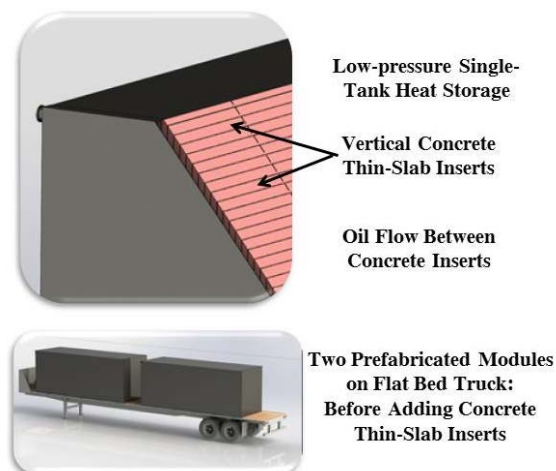

Fig. 2.5. Westinghouse Thermal Heat Storage Module for 1 MWh of Electricity Storage

Cryogenic Air Systems. A cryogenic air energy storage system stores energy by liquefying air. A less tightly coupled cryogenic system would use electricity to drive the chilling process; the option exists to more tightly integrate the chilling process with the nuclear plant and use steam turbines. The liquefied air can be stored in facilities similar to those used to store liquefied natural gas (LNG). The energy storage capacity of the liquid air reservoir can be enhanced through the integration of a sensible heat storage system. To produce electricity, the liquid air is compressed, heated using low-temperature heat (cooling water) from the power plant and then heated with steam from the NPP secondary side and sent through a gas turbine before being exhausted to the atmosphere.

This technology can be coupled to any heat source. A pilot plant is now operating in the United Kingdom that is coupled to a biogas power plant. The estimated round-trip efficiency for this technology coupled to a LWR is over 70%.

Packed-bed Thermal Energy Storage. A packed-bed thermal energy storage system (Fig. 2.6) consists of a pressure vessel filled with solid pebbles with a steam valve at the top and water outlet at the bottom. Heat is stored as sensible heat in the pebbles. To charge the system, steam is injected. The steam condenses as the cold pebbles are heated and water exits from the bottom of the vessel. At the end of the charging cycle all pebbles are hot and there is hot water filling the voids at the bottom of the vessel. To discharge the system, water is injected into the bottom of the vessel and steam is produced by the hot pebbles.

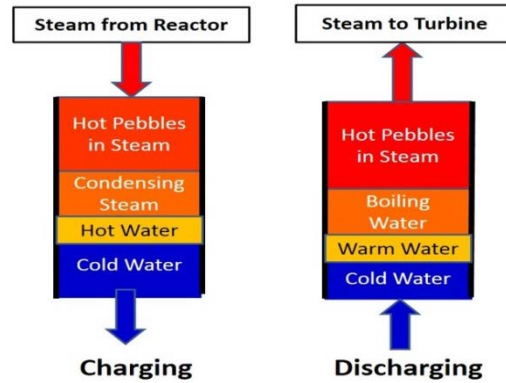

Fig. 2.6. Packed Bed Heat Storage System

In theory this should be the most efficient heat storage system in terms of round-trip efficiency. The heat storage system directly uses steam with no temperature losses in a heat exchanger in either direction—steam in and steam out. Packed beds are more thermodynamically efficient than other storage systems because they operate in a counter-current mode—the hottest steam sees the hottest pebbles. A sharp hot-to-cold front with small dimensions is only possible with a saturated-steam input where the very high heat transfer of condensation and boiling occurs over a very small zone in the bed. This is not true for superheated steam and other systems where the length of the heat transfer zone becomes excessively long relative to practical dimensions of real systems. Only limited analytical and experimental studies have been conducted on this heat storage option.

Hot Rock Storage. A hot rock energy storage system (Fig. 2.7) is similar in concept to a packed bed energy storage system except it operates at atmospheric pressure with air. A volume of crushed rock with air ducts at the top and bottom is created. To charge the system, air is heated using a steam-to-air heat exchanger delivering heat from the reactor, then the air is circulated through the crushed rock heating the rock. To discharge the system, the airflow is reversed, and cold air is circulated into the crushed rock at the bottom. This discharged hot air can be used to (1) produce steam for electricity or industry or (2) hot air for collocated industrial furnaces to reduce natural gas consumption.

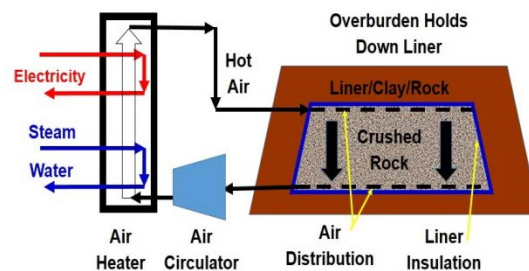

Fig. 2.7. Schematic of Hot-Rock Heat Storage in Charging Mode.

Heat storage systems are only charged at times of very low electricity prices. There is the option with

this system to first heat the air with a steam-air heat exchanger and then further heat the air with electric resistance heating. This can substantially boost rock temperatures and the efficiency of converting hot air back to electricity.

Only limited analytical studies have been done on hot rock storage. It potentially has very low incremental heat storage costs (crushed rock) that may enable its use to provide economic hourly to weekly heat storage.

Geothermal Heat Storage Systems. Nuclear geothermal heat storage systems combine the features of an enhanced geothermal energy facility with thermal energy storage. Thermal energy is stored by injecting hot water heated by steam from the reactor into the underground reservoir; energy is discharged by pumping hot water back to the surface for electricity production in a conventional geothermal plant. Limited studies have been completed but there are currently no development program or field experiments. The viability of geothermal systems depends upon the local geology. Significant research, development and demonstration would be required before deployment of this storage technology. This heat storage technology has different characteristics than the other heat storage options.

- *Seasonal heat storage.* It is the only heat storage option that is a candidate for seasonal energy storage because of the very low cost of the storage media—rock. This would enable hourly to seasonal thermal energy storage.
- *Strategic heat reserve.* This system has the potential for very low-cost multiyear storage, creating the option of a strategic energy storage reserve for a low-carbon society. It would replace the strategic oil reserve and other energy storage technologies based on fossil fuels.

Heat storage systems coupled to LWRs have the potential to be much less expensive than other storage options. In part this is because heat storage is ten to forty times less expensive than storing electricity (pumped hydro, batteries, etc.). In part this is because of the characteristics of the electricity market where large-scale wind or solar decreases electricity prices.

The addition of renewables results in large decreases in wholesale electricity prices for limited periods of time. Figure 2.8 shows the impact of solar additions between 2012 and 2017 on California electric prices on a spring day with high solar input and low electricity demand. Electricity prices collapse at times of high solar production. In this specific example the prices have gone negative because of government subsidies that allow the solar producer to pay the grid to take electricity to collect production tax credits. The price increases as the sun goes down because of lower solar electricity production and peak demand occurs in the early evening. As a result of these market factors, many utility solar thermal power plants are built with thermal storage systems while wind and photovoltaic systems do not include electricity storage systems (batteries, etc.) because of high costs.

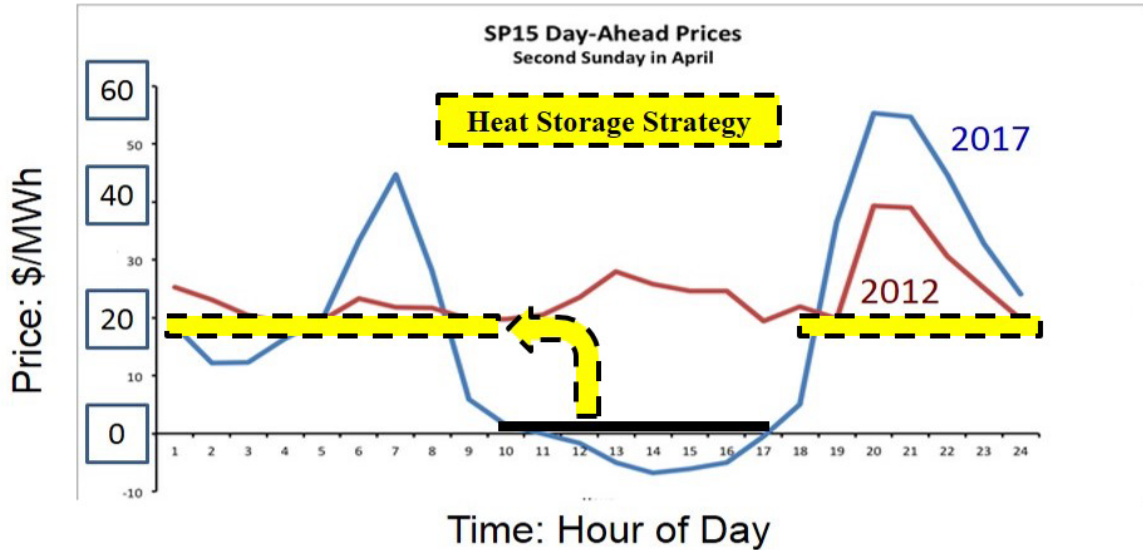

Fig. 2.8. Impact of Addition of Solar to the California Electricity Market on a Spring Day and Nuclear Storage Strategy to Address Changes in Market [California ISO 2016]

In heat storage systems the heat-to-storage input, storage, and heat-to-electricity output are separately sized. Accumulators and some other heat storage technologies have very low costs for heat addition to storage. In a market with large-scale solar the profitable strategy may be to send steam to storage 7 hours per day when prices are low and produce added electricity 17 hours per day. The storage system would have very high steam input rates into storage (low-cost part of system) and smaller peak electricity production rates (higher-cost part of system). Much of the cost is with the cost of converting heat-to-electricity that depends whether there is a stand-alone power system or an incremental increase in the nuclear steam turbine-generator set. When viewing the nuclear plant as a black box, the addition of storage would appear to have increased its “base-load” capacity by a small amount with the capability to ramp up and down very quickly.

Heat storage interacts with the market in a different way than electricity storage. In a pumped storage facility there are two major cost components. The first is the equipment used to pump water to the upper water reservoir that is also used to produce electricity at times of high demand. The second is the cost of the two water reservoirs. As a consequence the rate of energy input is about equal to the rate of energy output. In heat storage systems input, energy storage and output are separately sized. This allows optimization of the system to the needs of the specific market.

For many existing reactors it may be possible to send up to 20 to 25% of steam output to storage when prices are low with little or no upgrade of the turbine-generator to produce added electricity when prices are higher. For new plants there is the option of diverting 70+% of the steam to storage at times of low electricity demand and increasing the peak plant output by 25% or more.

2.2.2. Electricity to Heat Storage

Large-scale deployment of low-carbon energy sources (solar, wind, and then nuclear) result in very low electricity prices when output exceeds demand because of their low marginal operating costs of electricity production (Appendix A; Bistline, 2017). The prices go below that of fossil fuels creating the option of economically using electricity as a source of heat. We discuss Firebrick Resistance-Heated Energy Storage (FIRES) that converts low-price electricity into high-temperature stored heat for use in (1) industrial boilers and kilns and (2) Nuclear Brayton Power Cycles (Section 2.2.3). These technologies have the potential to address the challenge of electricity price collapse that impacts non-dispatchable wind and solar as well as nuclear. Only the industrial heat market energy demand is large enough and always available to consume all excess low-price electricity in a low-carbon energy system.

FIRES (Fig. 2.9) consists of a firebrick storage medium with a high heat capacity, density and maximum operating temperatures up to $\sim 1800^{\circ}\text{C}$ [Forsberg, 2017b; Stack, 2016; Stack, 2017]. The firebrick is heated using resistance heating with electricity at times of low or negative electricity prices. Low electricity prices are defined as electricity prices that are less than the competing fossil fuel on a per unit heat basis—that is in almost all cases natural gas in the United States. In Japan that could be coal or liquefied natural gas (LNG). The heat is recovered by blowing air through channels in the brick. The output of FIRES is hot air, which is heated or cooled as needed for the given application (industrial furnace or kiln) by adding natural gas heat or cold air, respectively. The required discharge rate is determined by the furnace hot-air requirements that FIRES is coupled to. FIRES is deployable today.

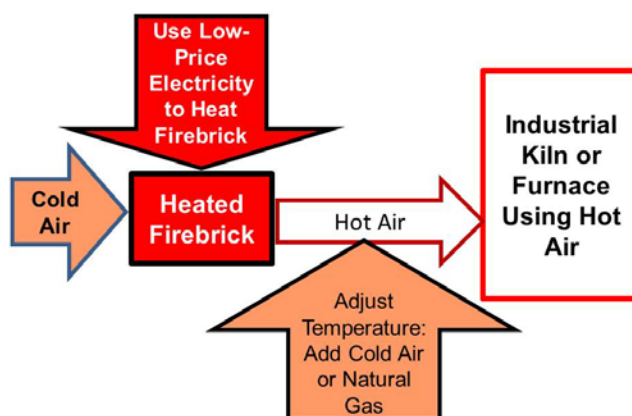

Fig. 2.9. Configuration of FIRES coupled with an industrial process

The firebrick, insulation, and other storage components are similar to high-temperature firebrick industrial recuperators. The ceramic firebrick is used because of its low cost, durability, and large sensible heat storage capabilities. If one allows a 1000°C temperature range from cold to hot temperature, the heat storage capacity is $\sim 0.5\text{-}1\text{ MWh/m}^3$. Electric resistance heating is used because it is the lowest-cost cost technology to convert electricity to heat.

Firebrick with electric heating is used for low-temperature home heating in Europe and elsewhere.

Some utilities offer a discount rate for electricity at night. At such times the firebrick is heated up to 600°C with electric resistance heaters. The hot firebrick then provides warm air when needed for room heating by blowing air through channels in the firebrick. Over 100,000 MWh of such heat storage capacity has been built with heat storage capacities under 100 kWh per unit. More recently there have been night discount rates on electricity in parts of China. This has resulted in development of similar units to provide hot air for heating water up to 85°C to provide hot-water heat and hot water for large apartment complexes. The larger firebrick heat storage units have capacities of 8 MWh. These units have peak firebrick temperatures of 850°C.

The recent deployment of wind and solar has resulted in electricity prices in parts of the United States going below the price of natural gas. There are efforts now underway to couple FIRES to industrial furnaces to use this excess electricity. To better understand potential impacts of large-scale deployment of FIRES on the grid, we examined the implications of adding PV and PV with FIRES to the Tokyo electricity grid [Haratyk, 2017]. Japan is in the process of deregulating electricity markets, has a large industrial heat demand with a commitment to maintain their industrial base, goals to decrease greenhouse gas emissions including large-scale deployment of utility PV, concerns about foreign trade deficits, and high-cost fossil fuels—a set of conditions that favor early deployment of FIRES. Previous studies [Komiya, 2014] showed the addition of significant PV would result in large-scale PV curtailment as significant capacity was added and electricity production exceeded demand.

To perform the analysis, we ran an economic dispatch model of the Tokyo electrical grid over one year (8760 hours). The model takes the demand for electricity, the solar generation profile, the installed generation capacity and its marginal cost to dispatch the generation and meet the demand at minimal cost. The price of electricity for each hour is determined by the marginal unit that serves the load. The demand is assumed to be the demand in the Tokyo Electric Power Company (TEPCO) area of service in 2014 [TEPCO, 2015]. The generation from solar PV is simulated based on sunlight exposure data from the meteorological agency of Japan and following the methodology of Esteban et al [2010]. It assumes a natural gas price of 9.68 \$/ MWh. One assumes that 50% of the nuclear generation capacity of TEPCO has restarted, and that the precipitation and river flows limit the hydro generation capacity to 1891 MWe.

The base case (3 GWe solar PV capacity installed) leads to a reference revenue of 72.1 \$/MWh for the solar PV owners and \$71.3 USD/MWh for nuclear power plants. The relative change in these values as solar penetration increases is illustrated in Fig. 2.10. The introduction of FIRES is modeled as a technology that would absorb all the excess cheap electricity (less than the price of natural gas) generated by solar, nuclear and hydro and prevent the curtailment of the electricity generation from these technologies. One assumes that FIRES has infinite storage capacity.

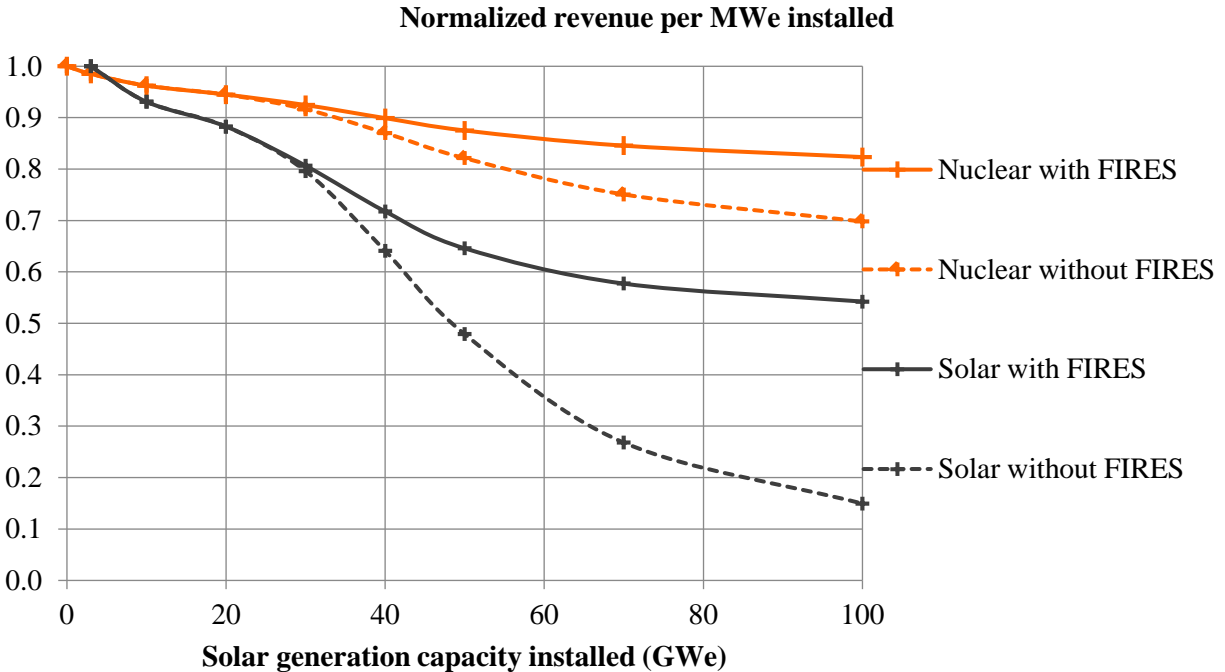

Fig. 2.10. Potential Impact of FIRES on Nuclear and Solar Plant Revenue

The addition of 50 GWe of solar to the Tokyo electric grid would produce about a quarter of the total electricity and in a deregulated market collapse the price of electricity in the middle of the day so the annual revenue for each solar PV system would be half of the revenue when the first PV system was installed. However, Japan imports liquefied natural gas (LNG) that is used in industrial furnaces at high costs relative to most other countries. If we assume FIRES transfers electricity as heat to the industrial sector at the price of natural gas, FIRES slows and then stops revenue decreases with increasing use of PV—enabling larger use of PV while reducing renewable subsidies, reducing imports of LNG, maintaining nuclear plant revenue and reducing greenhouse gas emissions. It reduces the downward slope of the marginal value of electricity.

In this specific case, FIRES would not be deployed until 25 to 30 GWe of solar is installed. It takes that much solar to drive electricity prices for a significant number of hours in the middle of the day below that of natural gas and thus make FIRES attractive. That is equivalent to producing somewhere between 10 and 15% of all electricity using solar.

FIRES could have been developed in 1920 if there had been a market because it uses very simple, low-cost technologies. It has been deployed at a limited scale in home heating where social policies (primarily to reduce air pollution) have provided very low-price electricity. The large-scale deployment of non-dispatchable wind and solar now create an economic basis for FIRES deployment—a change in the market.

2.2.3 Nuclear Brayton Cycles with FIRES and Brick Recuperator Heat Storage

Nuclear reactors produce heat and thus use heat engines to convert heat into electricity. FIRES produces high-temperature heat that can be coupled into some of these power cycles creating new power cycles that enable the power station to buy or sell electricity depending upon demand (market conditions) while the reactor operates at constant power.

Most of the work on these advanced power cycles is associated with Nuclear Air-Brayton Combined Cycles (NACC) coupled to Fluoride salt-cooled High-temperature Reactors (FHRs)—a reactor that uses high-temperature gas-cooled reactor fuel and a clean salt coolant. This power cycle is described herein. The power cycle could be coupled to any other reactor that delivers heat in the 600 to 700°C range including molten salt reactors (MSRs) where the fuel is dissolved in the salt and high-temperature variants of lead fast reactors (LFRs). Variants of these power cycles [Forsberg, April 2017] can couple to high-temperature gas-cooled reactors (HTGRs). The same technologies apply to some types of very high-temperature solar thermal power systems. This class of power cycles could not have existed 20 years ago—the gas turbine technology was not good enough. The technology is at an early stage of development.

From the perspective of the grid (Fig. 2.11), the reactor plant with NACC and FIRES buys electricity at times of low electricity prices and sells electricity at times of high electricity prices. NACC with FIRES is partly an electricity storage system with very different characteristics than traditional nuclear power plants from the perspective of the grid operator.

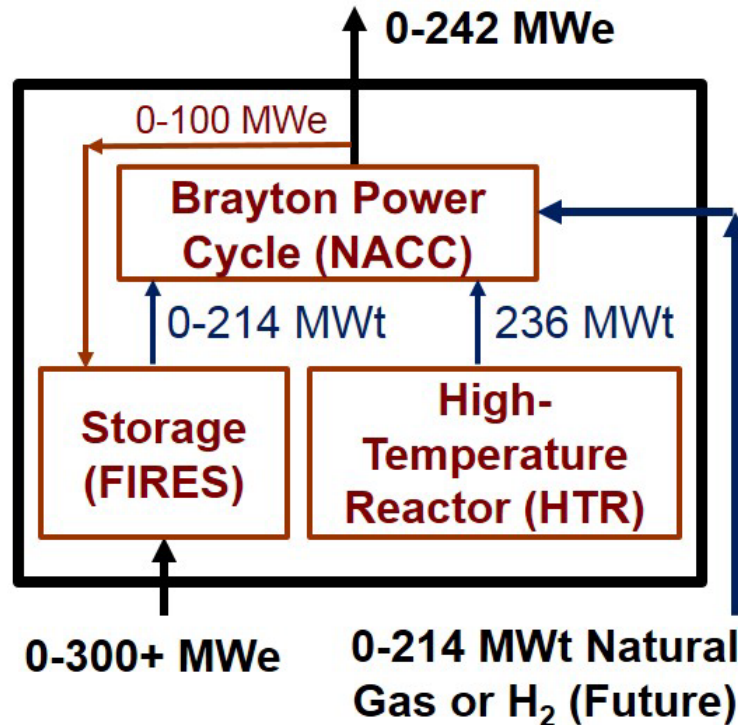

Fig. 2.11. Grid Perspective of High-Temperature Reactor with Supplemental Natural Gas Firing and FIRES

Base-Load Electricity

Figure 2.12 shows a schematic of the NACC power cycle [Andreades, June 2014; Fathi, 2016; Forsberg, October 2016b; Andreades, September 2016; KAIROS Power, 2017] that is being developed. During base-load operation (1) outside air is compressed, (2) heat is added to the compressed air from the reactor through the first heat exchanger, (3) the hot compressed air goes through the first turbine to produce electricity, (4) the air is reheated in a second heat exchanger and sent through a second turbine to produce added electricity, (5) the warm low-pressure exiting air goes through a heat recovery steam generator (HRSG) to generate steam that is used to produce added electricity and (6) air exits up the stack. The FHR is designed to deliver heat between 600 and 700°C to the power cycle with a NACC base-load heat to electricity efficiency of 42%.

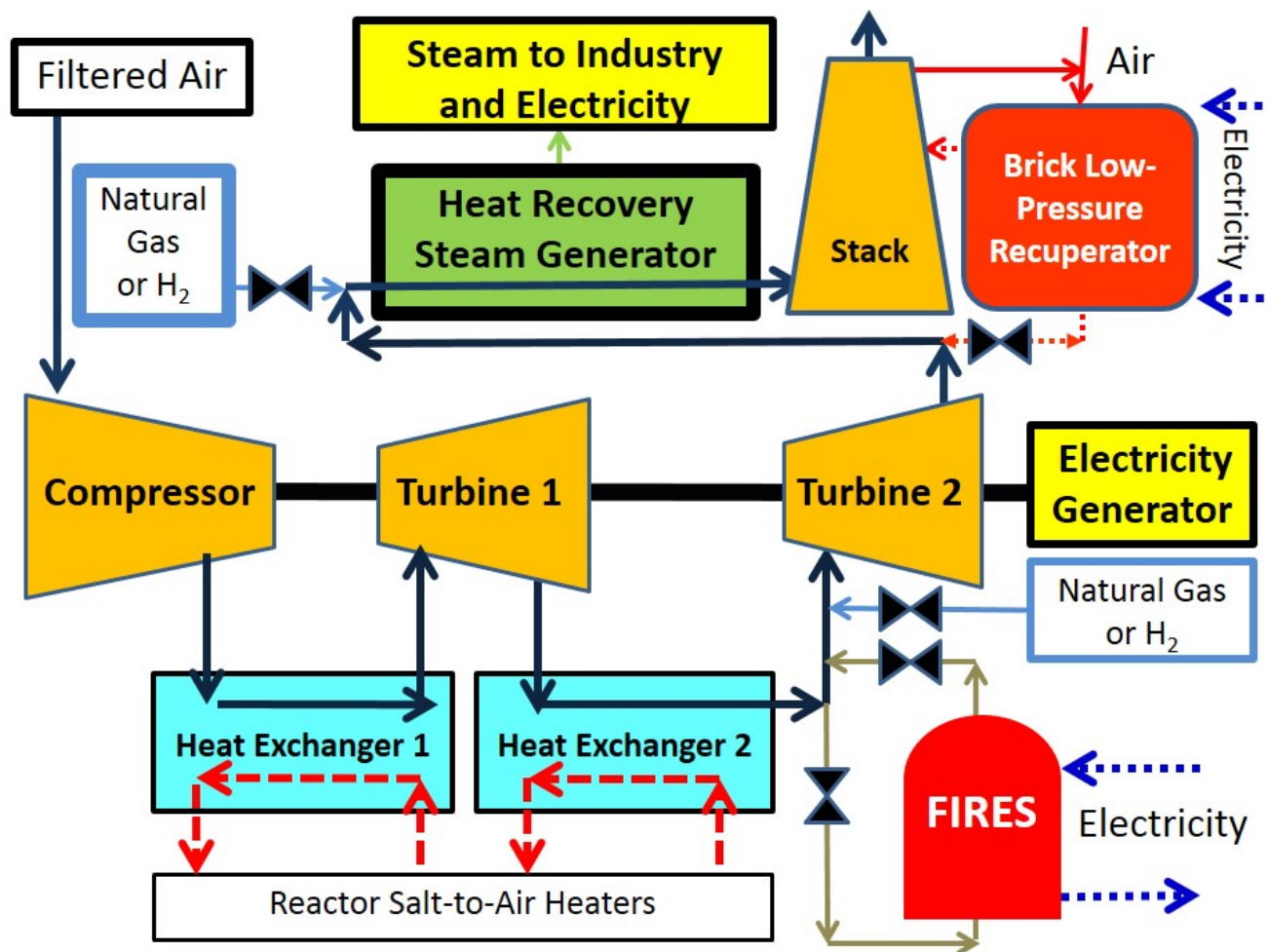

Fig. 2.12. NACC with Heat Storage and Use of Auxiliary Fuels (Natural Gas, Hydrogen, Stored Heat [FIRES and Brick Recuperator], Other).

Heat Production for Industry

Combined cycle plants are used in industry to produce electricity from the turbine and steam from the HRSG for industrial use. While natural gas is the most common fuel, chemical plants and refineries burn various byproduct waste gases and liquids as well as locally-generated low-value hydrocarbons. When electricity prices are high, these plants often sell electricity to the grid. Industrial combined-cycle gas turbines have one other characteristic. They include auxiliary gas burners to provide heat to the HRSG if the gas turbine is shut down for any reason. This assures steam to the industrial user. Electricity can be bought from the grid when the turbine is shut down.

This traditional industrial model has major implications for the use of NACC. It implies NACC coupled to a HTR can provide industrial steam with the same high assurance of steam supply as existing combined cycle plants by including natural gas (or hydrogen or biofuel) burners for the HRSG. If the reactor goes down for refueling, it does not impact steam production. There is no need for multiple reactors to assure steam supplies.

Peak Electricity Production Using Natural Gas or Hydrogen (Future)

The NACC base-load temperature is determined by the materials of construction of the reactor coolant-gas turbine heat exchanger. With typical materials, that limit is near 700°C. If more exotic and expensive alloys are used, that temperature can be increased. While these are high temperatures for heat exchangers, they are low temperatures for gas turbines, where there are industrial gas turbines with peak temperatures near 1400°C and industrial turbines on the test stands with temperatures near 1600°C. Much higher temperatures are possible because gas turbine blades can be cooled from the inside with ceramic coatings on the outside to insulate the turbine blade from the high combustion temperatures.

Consequently, in a gas turbine there is the option of adding heat after the nuclear heating to further raise compressed gas temperatures before entering the second power turbine—a topping cycle. The added high-temperature heat can be provided by natural gas, hydrogen, another combustible fuel or stored heat. In our studies the gas turbine is a modified GE 7FB gas turbine—the largest rail transportable gas turbine made by General Electric. Heating the compressed air up to 1065°C results in an incremental heat-to-electricity efficiency of 66.4%—the most efficient system available using existing technology to convert heat to electricity. For comparison, the same GE 7FB combined cycle plant running on natural gas has a rated efficiency of 56.9%. An overview of the cycle is shown in Figure 2.13.

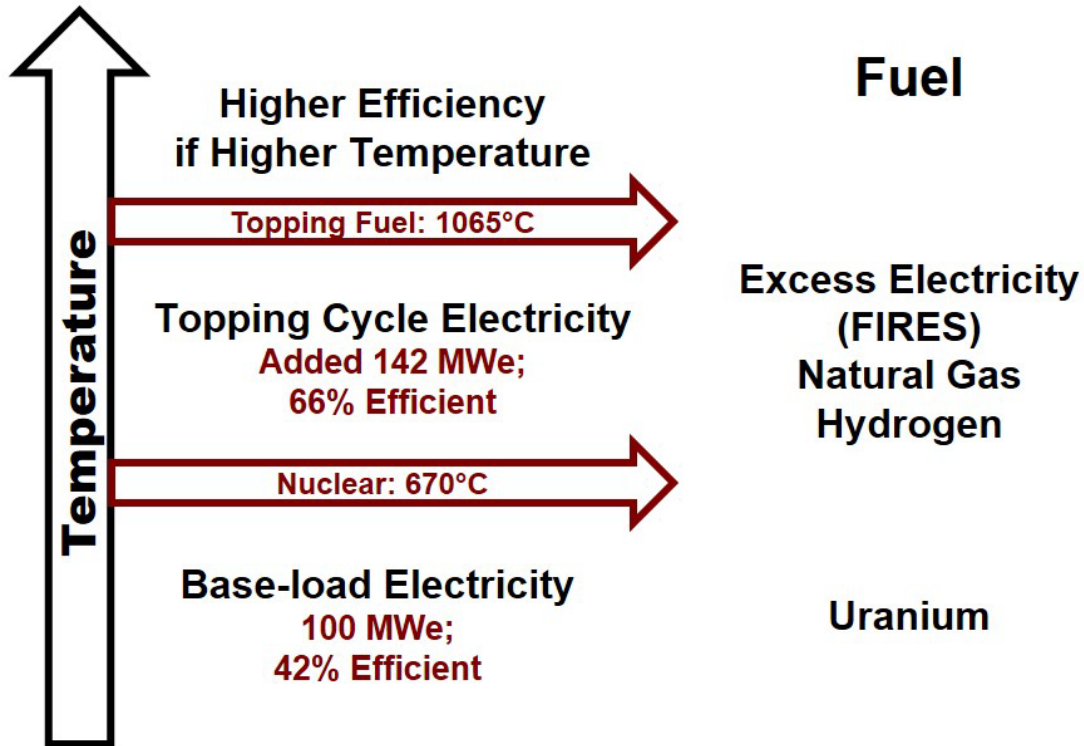

Fig. 2.13. Nuclear Air-Brayton Combined Cycle (NACC)

This design was optimized for base-load electricity. If optimized for peak power efficiency (radiant heat boiler section in HRSG, higher temperature gas turbine blades, etc.), the incremental heat-to-peak electricity efficiency would approach ~70%. Newer gas turbines can operate with much higher peak efficiencies. The continuing advances in gas turbines for utility and aircraft applications are expected to raise these efficiencies while meeting other constraints such as low NO_x emissions.

The thermodynamic characteristic of a high-temperature topping cycle is that it is the most efficient method to convert incremental heat into electricity. The economics are based on using a low-cost fuel (uranium) to provide heat at lower temperatures for base-load electricity production and a more expensive fuel (natural gas, stored heat, hydrogen, etc.) to provide added heat to the power cycle at higher temperatures and efficiencies for additional peak electricity output. If natural gas is used as the peaking fuel, the higher efficiency in converting natural gas to electricity relative to stand-alone combined cycle natural gas plants gives these plants a competitive advantage—more electricity for less natural gas.

Peak Electricity Using FIRES High-Temperature Stored Heat

In the operation of NACC with FIRES providing the heat source for peak electricity production, (1) the reactor would operate at base-load, (2) electricity would be bought when prices are low and stored as high-temperature heat using FIRES—including the electricity generated by base-load NACC operations, and (3) the reactor and FIRES high-temperature heat would be used to produce peak electricity at times of high prices. The system enables base-load reactor operation with variable electricity to the grid and

increasing revenue relative to a base-load reactor. FIRES is the only technology that can store high-temperature heat for the peaking cycle because only firebrick has the high-temperature capability to directly transfer heat from hot brick to compressed air. Any heat storage technology with a heat exchanger will not work because of the materials limits of the heat exchanger.

In a very low-carbon world with strict limits on carbon dioxide releases, NACC can operate with FIRES and hydrogen for peak power production. The FIRES round trip electricity-to-heat-to-electricity efficiency is near 65% because electricity-to-heat efficiency is ~100% with the losses almost entirely in the heat-to-electricity conversion step. In contrast, energy storage options using hydrogen or other storable fuels have considerably lower round-trip efficiencies. The electricity-to-hydrogen conversion efficiencies are typically less than 70%, implying a round-trip efficiency of less than 50%. This creates large incentives to maximize use of FIRES for variable electricity production because of the higher round trip efficiency. However, the cost of the pressure vessel makes FIRES expensive for long-term heat storage. In contrast, hydrogen can be stored cheaply using the same technologies as used to storage natural gas. This suggests that in a very low carbon world FIRES with NACC provides hourly to weekly storage for the electrical grid whereas hydrogen becomes the leading candidate for longer-term energy storage.

Normally it would be expected that the efficiency of a storage system that converts electricity to heat to electricity would be low and thus uneconomic. That is not true here because the heat is added as a topping cycle above “low-temperature” 700°C nuclear heat. The electricity to heat efficiency is ~100% and the heat to electricity efficiency is 66.4% for a round-trip efficiency of about 66% with existing turbines. With projected improvements in gas turbines, the round trip efficiency may approach 75% by 2025. The storage efficiency is similar to many other storage technologies (pumped hydroelectric) but uses low-cost heat storage. It is a new class of nuclear power systems because of its fundamentally different characteristics.

Lower Temperature Low-Pressure Firebrick Recuperator Heat Storage

Heat storage can be added between the gas turbine and Heat Recovery Steam Generator (HRSG) in the form of a firebrick recuperator (Fig. 2.13). If electricity prices are low or heat (steam) demand is low, the hot air from the turbine is partly or fully diverted from the HRSG into a recuperator where it heats brick and then is exhausted to the stack. At times of high electricity or heat demand, fans send cold air through the firebrick recuperator that is heated to provide added hot air for the HRSG. This technology is commercially available at low costs because it operates at low pressures and low temperatures (<800°C).

In Europe, the United States and Japan, large-scale wind and solar deployment results in more hours of very low electricity prices on the weekends than the weekdays because of lower weekend demand for electricity. The low cost of a brick recuperator allows dumping massive quantities of heat from the reactor over the weekend to be used during the five-day workweek for electricity production. There is also the option of adding electric resistance heaters to convert added excess electricity from the grid into stored high-temperature heat. However, the stand-alone efficiency of heat-to-electricity is less than the high-temperature high-pressure FIRES that is coupled into the Brayton power cycle. Most other storage technologies are too expensive to address the weekday weekend electricity price swing.

If auxiliary natural gas is not being used with the HRSG, stack gas rather than air would be sent through the brick recuperator to move heat to the HRSG. This gas will be warmer than outside air and increase the efficiency of recycling heat.

2.2.4. Heat Storage in the Reactor Core

High-temperature gas-cooled reactor (HTGR) cores contain massive quantities of graphite for neutron moderation and safety. Recent studies of the proposed Japanese GTHTR300C (Fig. 2.14) (GTHTR: Gas Turbine High-Temperature Reactor) suggest the potential to quickly vary power plant output by 20% relative to base load (Fig. 2.15) while the reactor fission power output constant (Appendix B). This is made possible by the direct-cycle gas turbine power conversion system. The graphite temperature is allowed to go up and down in temperatures as the heat storage material. In this particular reactor, the core of the 600 MWt HTGR has a thermal capacity of 373 MJ/K (373 MWs/K). In effect, the GTHTR300C acts as a power plant with built-in thermal storage system by using a graphite that is required for its nuclear operation for a second purpose.

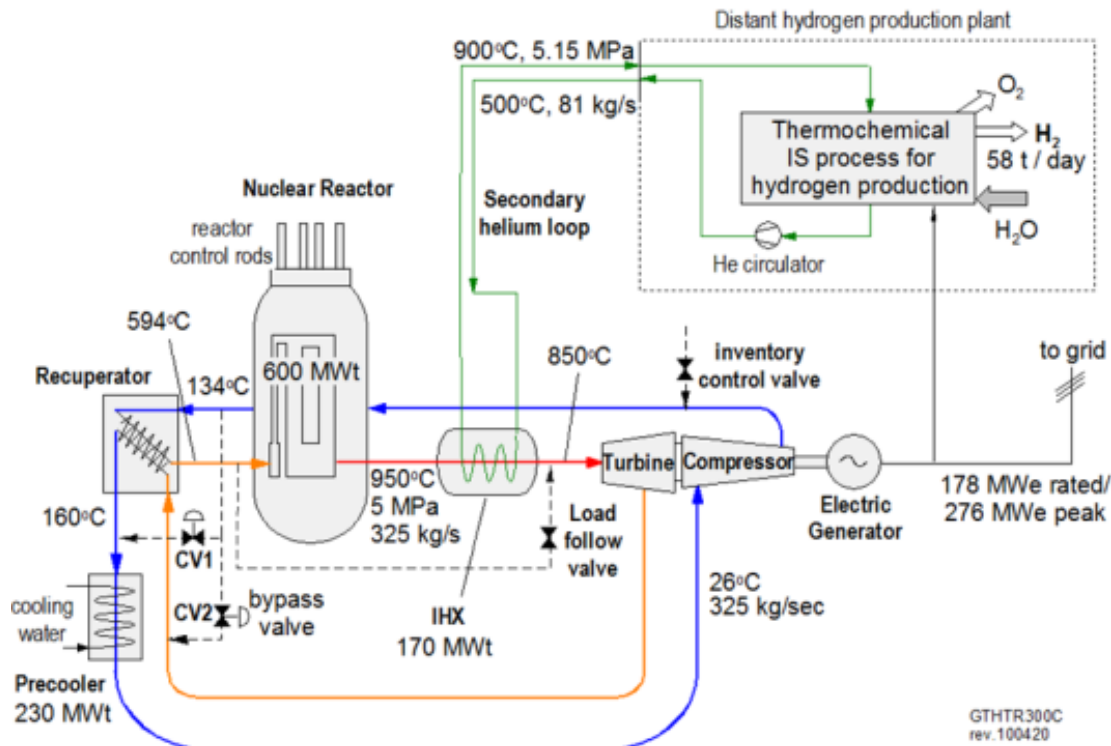

Fig. 2.14. Schematic of GTHTR300C Power System

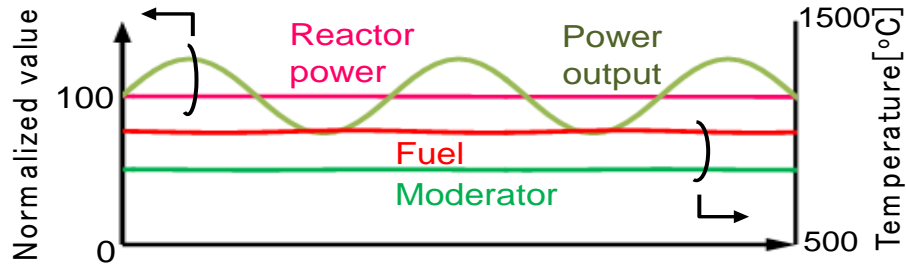

Fig. 2.15. Reactor Response to Provide Variable Output on a Minute Scale

The Japanese HTGR program has had long-term goals to develop a high-temperature reactor to provide high-temperature heat for industry, electricity production and hydrogen production (Fig. 2.16). The program built and operates the High-Temperature Test Reactor (HTTR). The goals did not include a high performance reactor to provide variable electricity to enable larger-scale integration of renewables into the electricity grid but the reactor under development appears to have that capability. What this example and other examples show is the capability to build nuclear systems with different capabilities for a low-carbon world.

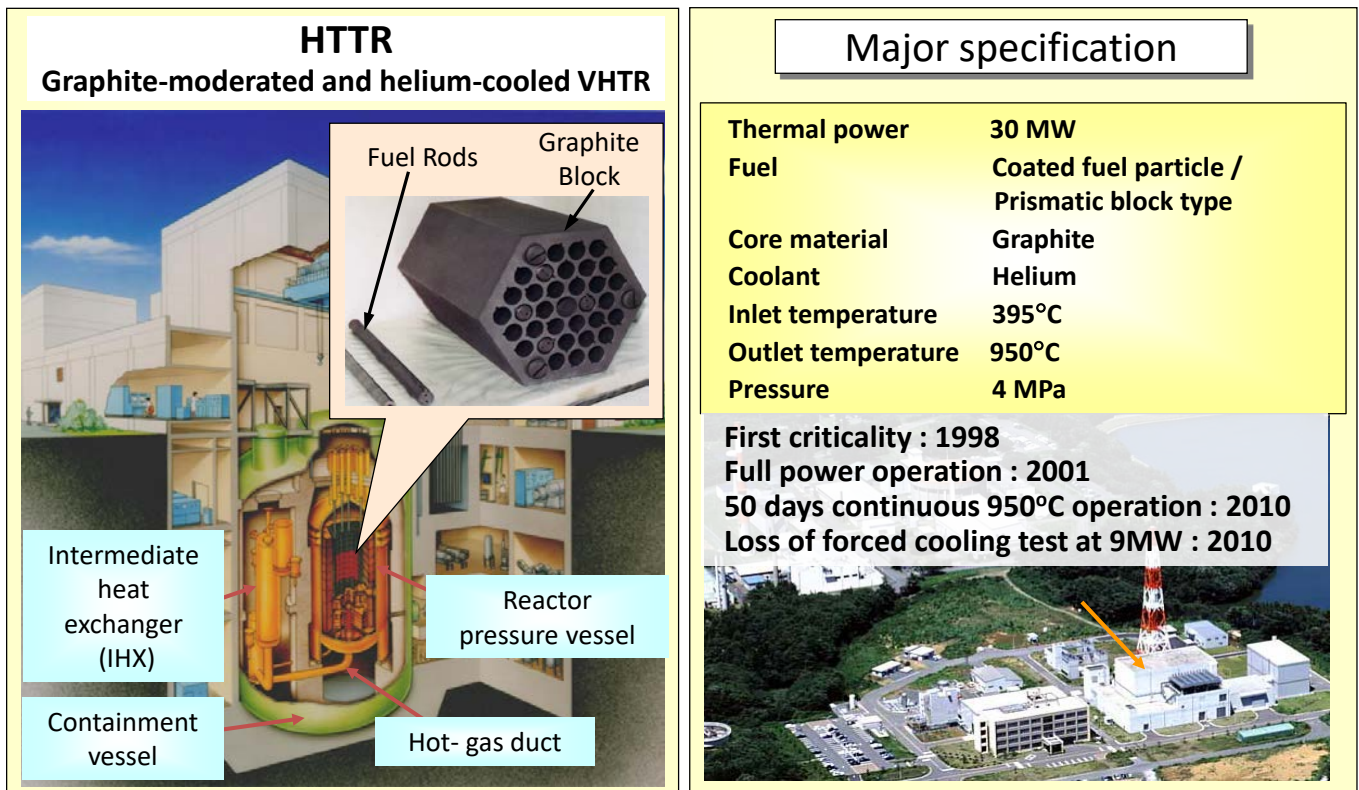

Fig. 2.16. Japanese HTGR Program

2.2.5. Dispatchable Electricity for a Low-Carbon World

Society's need for dispatchable energy has historically been provided by fossil fuels. There was no need and thus no incentive, except in a few special cases, to develop nuclear power systems for dispatchable energy output. In a low-carbon world one requires an alternative method to provide dispatchable energy to match society's need for variable energy. Nuclear energy can meet that role by varying the output of the reactor—as has been done on a limited scale. Alternatively, variable output can be provided by coupling nuclear energy to heat storage systems to enable the nuclear reactor to operate at full capacity to minimize costs. Nuclear power by many people is thought to be a technology limited to providing base-load electricity because that is what it was asked to do. The technical and economic capabilities are much larger if there is a need.

Wind and solar PV are electricity producing technologies and thus couple to electricity storage technologies (pumped hydro, batteries, etc.). Nuclear power plants that produce electricity can adopt the same strategy. However, nuclear and solar thermal systems are heat producing technologies and thus efficiently couple to heat storage technologies. Heat is less expensive to store than electricity reflecting the fundamental differences between heat and electricity.

We have described the options as they exist today, but so little work has been done that there may be many other options to couple nuclear reactors to heat storage for economic dispatchable electricity to replace this role of fossil fuels.

2.3. Non-Electrical Energy Systems: Heat and Energy Carriers

2.3.1. System Characteristics

The characteristics of fossil fuels have created a decoupled energy system where electricity production is largely decoupled from other parts of the energy system that provide heat and other forms of energy to the economy. The requirements of a low-carbon world will likely require an integrated energy network (Figure 2.17) that couples the electricity sector with the rest of the energy sector.

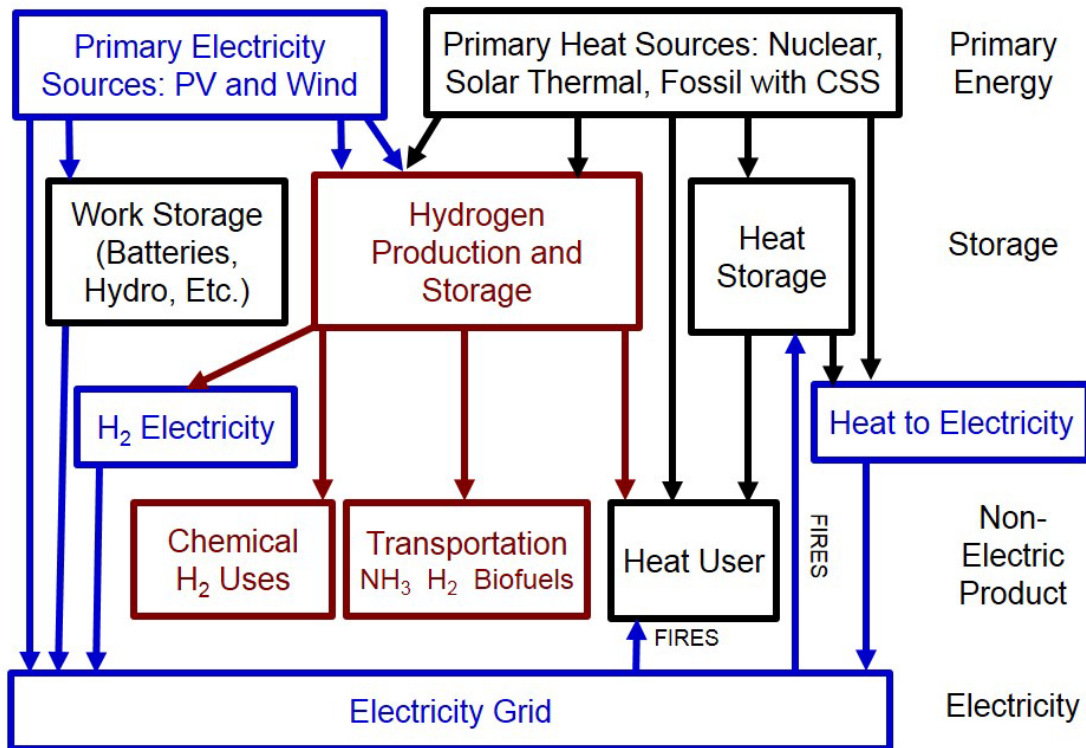

Figure 2.17. Integrated Energy Network

In a low-carbon energy production system there is a division between primary non-dispatchable energy sources that produce electricity (work: wind and solar PV) and primary dispatchable energy sources that produce heat (nuclear, solar thermal, and fossil fuels with carbon capture and sequestration). The other difference is likely to be the future coupling of the chemical, transportation, and heat markets with the electricity market. These energy markets are larger in total than the electricity market and their energy requirements are met today with a supply chain that is separate from that of the electricity grid. Figures 2.18 and 2.19 show the energy markets of the United States and Japan and the relative size of these markets. The industrial market is primarily for heat. The transportation systems are primarily dependent upon oil.

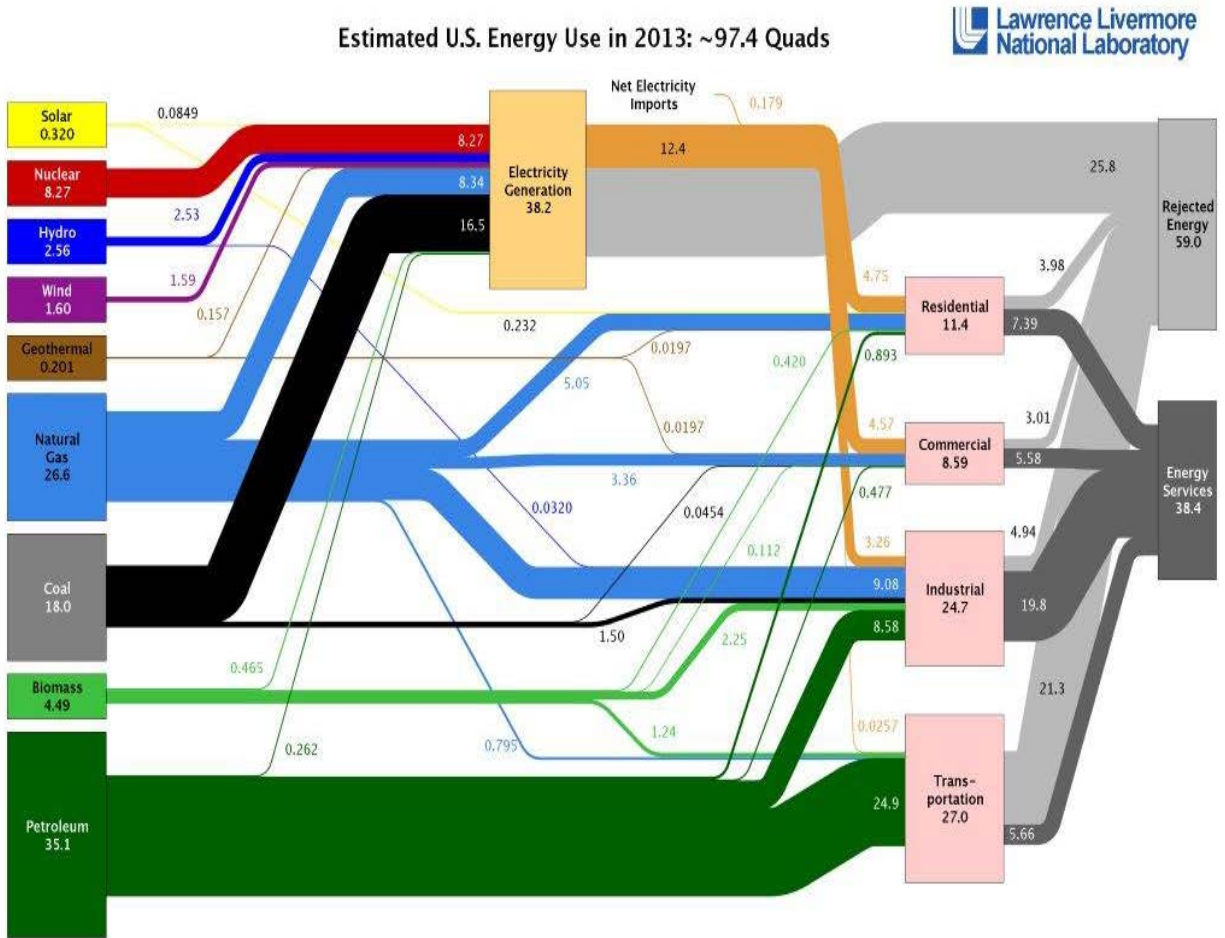

Figure. 2.18. Energy Consumption in Quads by Sector in the United States

(10¹⁵J)

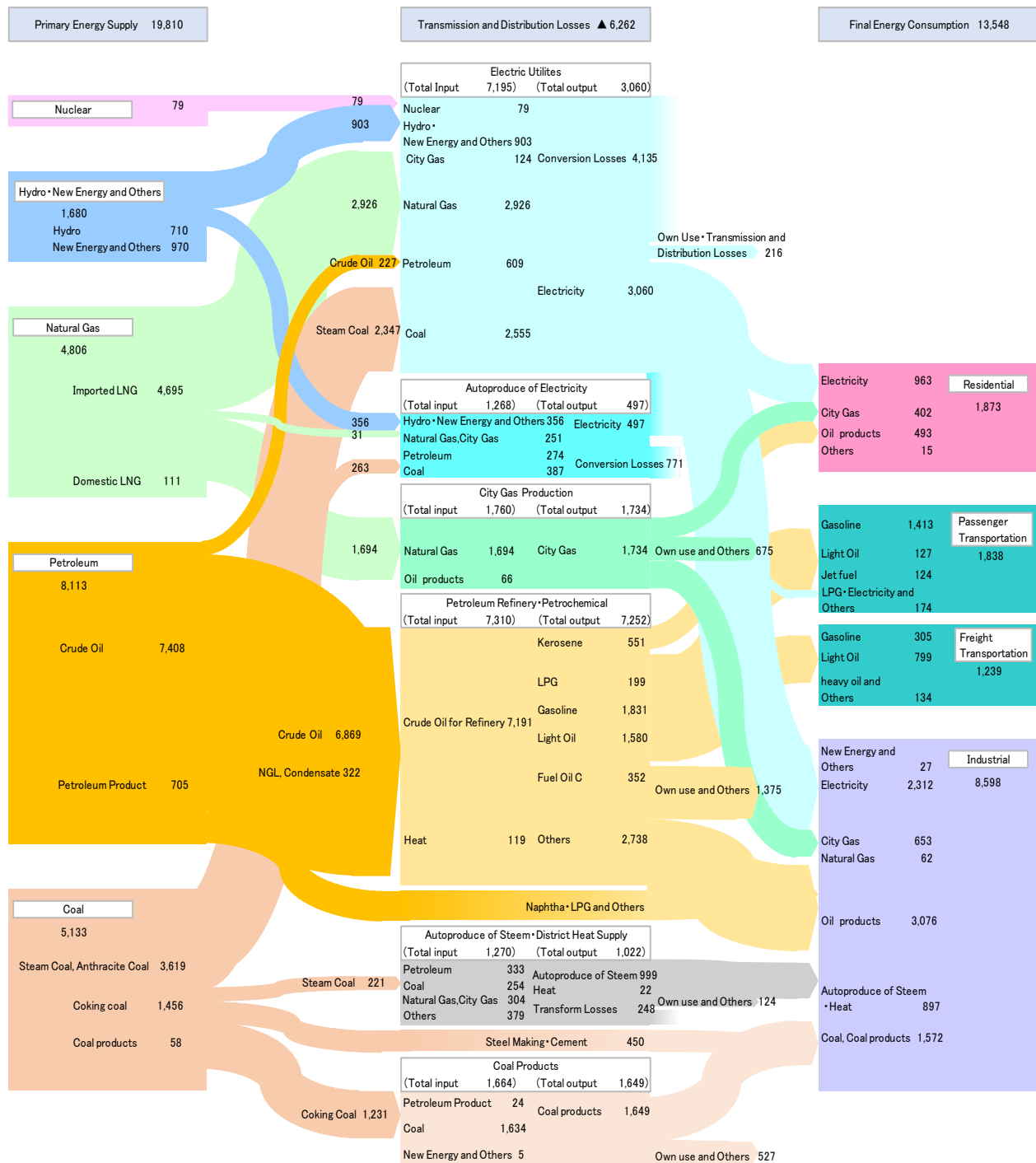

Figure 2.19 Energy Consumption by Sector (Energy Balance Flow 2012) in Japan
 (Source: Energy White Paper by METI, 2014)

We do not know today how the electricity market will couple to these markets. There are many options but most of the technologies are only partly developed and the economics of most of those options are not

well understood. We can identify three major energy carriers that move energy from primary energy production systems (nuclear, wind, and solar) to energy users that produce energy services (warm homes, food, transportation, communication, etc.).

- *Electric Economy.* If this route is taken, energy input for other markets is provided by electricity. FIRES becomes a central technology to convert variable-priced electricity into high-temperature stored heat to meet variable heat demands, primarily by industry. In the transport sector, electrification requires the development of high-performance low-cost, low-weight batteries or equivalent electricity storage technologies.
- *Heat Economy.* If this route is taken, nuclear energy (a heat production technology) provides heat to the big industrial markets with the deployment of large-scale heat storage technologies and heat transport technologies.
- *Hydrogen Economy.* If this route is taken a secondary storable energy carrier, an alternative to electricity, is produced that becomes the replacement of storable fossil fuels. Hydrogen is the most likely secondary storable energy carrier but is not the only candidate. It is the leading candidate because (1) it is a low-carbon fuel, (2) hydrogen can be stored economically on a large scale using the same technologies used to store natural gas (underground storage in salt caverns and certain other permeable geologies), (3) hydrogen can be moved by pipeline long distances, and (4) the feedstock (water) is available in unlimited quantities. There are also hydrogen carriers such as ammonia (NH₃)
-

The above options can transport energy to any stationary energy consumer. However, it is extraordinarily difficult to replace liquid hydrocarbon fuels for some applications such as aircraft and long-distance trucks. Because liquid hydrocarbon fuels for transport are so central to society, society must consider the possibility that there is no practical substitute for many applications. If that is the case, their manufacture could well be the primary use of energy after electricity production. We discuss in Section 2.3.4 the options to make low-carbon hydrocarbon fuels—options where in most cases require massive inputs of hydrogen.

2.3.2. Heat Economy

Heat has less value and cheaper to produce. Thermodynamics limits the fraction of heat that can be converted to electricity depending upon the temperatures (Carnot cycle) but 100% of electricity can be converted to heat. It is much less expensive to store than electricity but storage costs relative to ammonia and hydrogen depend upon the circumstances.

If this route is taken, nuclear energy (a heat production technology) provides heat to the big industrial markets with the deployment of large-scale heat storage technologies and heat transport technologies. Recent advances in moving heat as hot water may enable transport distances over 200 kilometers [Safa, 2012] with affordable losses; however, there are technical and economic challenges to move high-

temperature heat over long distances—limitations that do not exist for electricity or hydrogen.

Unless efficient methods are found to move high-temperature heat over long distances, high-temperature reactors that provide high-temperature heat to industry will need to be co-sited with industrial facilities. As discussed later, that creates a different set of requirements for these reactors.

2.3.3. Energy Carriers: Hydrogen, Ammonia and Others

Today most energy is delivered to customers in the form of fossil fuels (coal, oil, natural gas, etc.) by truck, train, pipeline and ship. Some energy is delivered as electricity by grid. If there are no fossil fuels, what are the non-electrical options to move energy from nuclear, wind, and solar plants to customers? Three leading candidates are discussed herein

The option of making hydrocarbon fuels and using the existing energy transport system is discussed in the following section. Hydrocarbon fuels are an energy carrier but in a special category. If low-carbon hydrocarbon fuels can be economically produced, they imply no massive changes in much of society in the process of going from a fossil-fuel world to a low-carbon world.

2.3.3.1. Hydrogen

Hydrogen is the most likely secondary storable energy carrier because (1) it is a low-carbon fuel, (2) hydrogen can be stored economically on a large scale using the same technologies used to store natural gas (underground storage in salt caverns and certain other permeable geologies), (3) hydrogen can be moved by pipeline long distances, and (4) the feedstock (water) is available in unlimited quantities.

Hydrogen can be produced by four routes without emission of carbon dioxide. The preferred route will depend upon relative advances in technology and the relative costs of electricity versus heat versus time (daily through seasonal).

- *Steam reforming.* The primary method to produce hydrogen today is steam reforming of fossil fuels (natural gas, oil or coal). The byproduct is carbon dioxide that in a low-carbon world could be disposed of by carbon capture and sequestration. Most of the energy in the fossil fuel is converted to hydrogen but some fraction of the fuel is used to create heat needed in the process. The carbon dioxide emissions from the process can be reduced by supplying required heat from a nuclear reactor.
- *Electrolysis of water.* Electricity is used to convert liquid water to hydrogen and oxygen [Randolph, 2017]. This is a commercial technology with many suppliers. It is primarily used in locations where there is a small demand for hydrogen.
- *High-temperature electrolysis (HTE).* HTE is steam electrolysis of water that requires heat and electricity [Randolph, 2017; O'Brien, 2010]. The United States leads in the development of this technology. In a low-carbon world the heat would most likely be provided by nuclear reactors with the electricity from the grid. Figure 2.20 shows the theoretical minimum heat and electricity input

to produce a unit of hydrogen. At higher temperatures, more of the energy input is in the form of heat than electricity.

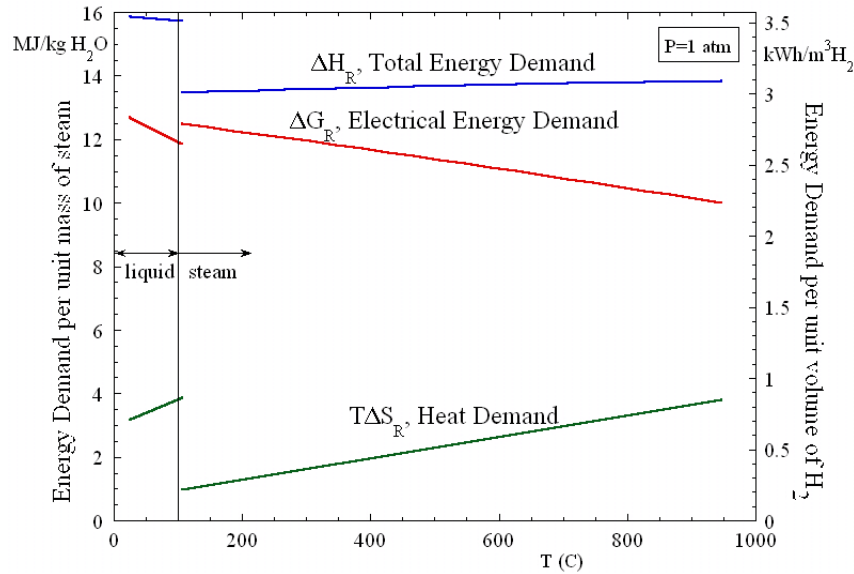

Fig. 2.20. Theoretical Energy Input for High-Temperature Electrolysis

This technology may be widely deployed if we integrate the electricity grid with other energy systems. The higher temperature operations avoid the need for expensive chemical catalysts associated with low-temperature water electrolysis. Second, the hydrogen output can be increased by boosting voltage with some reduction in efficiency that allows higher hydrogen production rates when electricity prices are low. Third the process is reversible; that is, the process can be operated in reverse with hydrogen input to produce electricity when needed as discussed below.

- *Thermochemical cycles.* These cycles only require heat input to convert water into hydrogen and oxygen via a series of chemical reactions. Japan leads in the development of this technology (Appendix B). Current thermochemical processes require high-temperature heat, most likely from a high-temperature reactor, and are a leading long-term option if the goal is steady-state production of large quantities of hydrogen. This should be the most efficient hydrogen production method if the initial energy input is heat. The leading process is the iodine-sulfur process that involves three chemical reactions where the net chemical reaction is heat plus water yield hydrogen and oxygen.

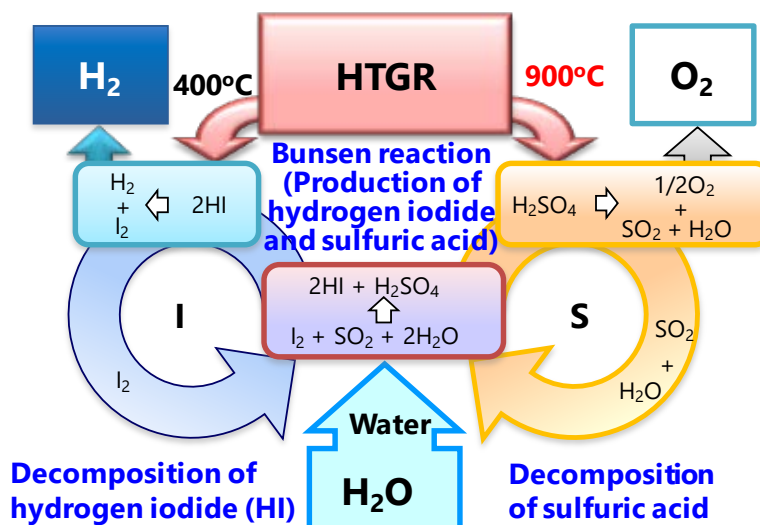

Figure 2.21. Iodine Sulfur Process for Production of Hydrogen from Water

There are three major hydrogen markets with different characteristics [Forsberg, 2007].

Chemical feedstock. The chemical market uses hydrogen as a chemical feedstock. This market includes production of chemicals such as ammonia (a fertilizer, NH₃) and hydrogen as a chemical reducing agent rather than using carbon as a chemical reducing agent for production of metals. In most of these applications in a low-carbon world there are no alternatives (ammonia production) or only a very limited number of alternatives. For this reason there is agreement within the technical community that any low-carbon future will require large quantities of hydrogen.

One of the largest potential markets in a low-carbon world for hydrogen is steel making where blast furnaces use coke made from coal to chemically reduce iron oxide to iron—a process that generates large quantities of CO₂. Japan has conducted major studies on nuclear steel making using hydrogen as a chemical reducing agent rather than carbon. In Japan in 2014 more than one third of CO₂ emission of 426 million tons per year was due to industry. Steel making is the biggest emitter in the industry with 190 million tons per year which is about 15% of total CO₂ emission by Japan, close to the emission of transportation sector at 17%.

Table 2.2. Annual Carbon Dioxide Emissions from Japan in FY 2014

Total Greenhouse gas	1,364 million tons	
CO ₂	1,265	100%
CO ₂ energy related	1,189	
Industry total	426	33.7%
Steel	190	15%
Chemical	67	5%
Cement	40	3%
Transportation	217	17%

Most iron today is produced in blast furnaces using coke—a process that is done on a large scale and where there is massive industrial experience. There is limited experience in direct reduction of iron using hydrogen—partly due to economic factors. Coke as a reducing agent can be replaced by hydrogen with the option of producing hydrogen using nuclear energy. A study by Yan et al [2012] using the IS process (above and Appendix B) examined steel making using the proposed 600 MWt GTHTR300C as shown in Fig. 2.22 and Table 2.3.

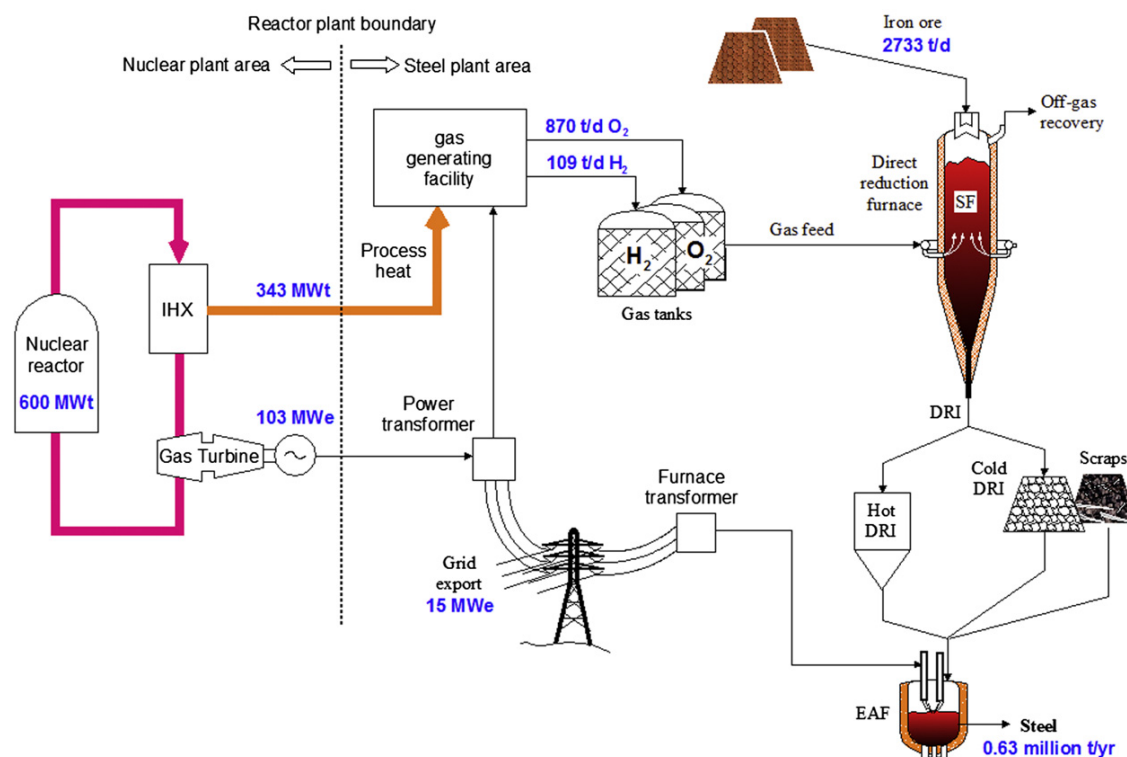

Fig. 2.22. Schematic of GTHTR300C nuclear steelmaking system based on a unit of nuclear reactor

Table 2.3. Basic Plant Parameters of the Nuclear Steel System based on 600 MWth HTGCR.

Plant parameters	Values
Reactor power	600 MWt
Coolant outlet temperature	950 _C
Coolant pressure	5.2 MPa
Turbine inlet temperature	750°C
Heat generation	343 MWt @ 900°C
Power generation	103 MWe
Hydrogen production	109 t/d
Oxygen production	870 t/d
Steel production	628 kilo-t/yr
Steel cost	US\$628/t-steel
CO ₂ emission	13.8 kg/t-steel

In this system 57% of nuclear heat is used to produce hydrogen by water splitting process (IS) and the other 43% for power production. Almost 90% of electricity produced is used in the steel making process with only 15 MWe of electricity exported to the grid. A total of 628,000 tons of steel are produced per year. Annual Japanese steel production is about 80 million tons per year. If nuclear steelmaking was used, 130 HTGRs would be required that would reduce Japanese CO₂ emissions by 15%

Transportation. The second hydrogen market is transportation where the likely long-term competition is between batteries and multiple options involving hydrogen. The hydrogen transport option that has received the most attention is direct use of hydrogen as a fuel; however, hydrogen is difficult to store on a small scale as required for a vehicle. Hydrogen could be converted into alternative fuels such as ammonia that are easier to store in a vehicle. Last, hydrogen can be used to boost the quality and quantity of liquid fuels per ton of biomass or other carbon forms into liquid fuels such as gasoline, jet fuel and diesel (See section 2.3.4). For some biofuels, the hydrogen input is over 40% of the final energy content of the biofuel; that is, the biofuel from one perspective is a hydrogen carrier. In this context, it is entirely possible that the United States with abundant biomass feed stocks might ultimately use biofuels with massive hydrogen input as the primary method to meet its transport fuel needs while Japan with limited supplies of biomass uses hydrogen directly as the primary method to meet its transport fuels. This is an example of where going from a “flat” fossil world to a low-carbon world may result in different energy systems in different parts of the world.

Hydrogen to Heat. Unlike the above applications, this use of hydrogen is not tied to its unique chemical characteristics to meet special demands of the chemical industry or transportation. For most applications (excluding transportation and chemicals), this option is likely to be less efficient than direct use of electricity because energy conversion processes have inefficiencies. Each time energy is converted from one form to another, there are losses. As shown in Figure 2.17, the routes from heat and electricity to hydrogen and back to heat involve multiple energy conversions that each have inefficiencies and thus cost impacts. However, hydrogen storage costs can be very low whereas electricity storage costs are higher—the economics depends upon more than just efficiencies.

Hydrogen to Electricity

With current technologies converting electricity to hydrogen and back to electricity has an efficiency between 30 and 40% [Rudolph, 2017]. Hydrogen is a premium fuel; thus, its use is likely to be limited to premium applications in the electricity markets. Two examples are described herein.

Nuclear Air Brayton Power Cycles. Some 60 to 70% of the energy is lost in the conversion processes. This efficiency can be improved if the hydrogen is used in NACC—the most efficient technology to convert incremental heat to electricity.

Special Electrical Markets. There is one clearly identified exception to the use of hydrogen for peak

electricity [Forsberg 2013]. The requirement to avoid blackouts requires utilities to buy gas turbines to meet peak demand. Many of these turbines operate only a few hundred hours per year. Figure 2.23 shows the number of hours per year for peaking units in the Midwest United States. This grid has a capacity of about 100 GWe. About 10% of the grid generating capacity has very low capacity factors where fuel costs are less important than the capital costs of the generating plants. Recent studies [Denholm, Margolis, 2007] show that the addition of renewables such as PV will dramatically increase the fraction of the grid generating capacity with very low capacity factors. High-temperature electrolysis has the ability to operate in reverse as a high-temperature fuel cell at almost no additional capital costs. HTE can be installed to produce hydrogen for industrial applications but much of its capital costs can be paid for by replacing low-capacity gas turbines required for peak electricity production. The lower round-trip efficiency of electricity to hydrogen to electricity is not very important in this specific case because only small quantities of hydrogen are used. It is much more important to avoid the high capital costs of any electricity generation system made possible by the dual capacity of HTE.

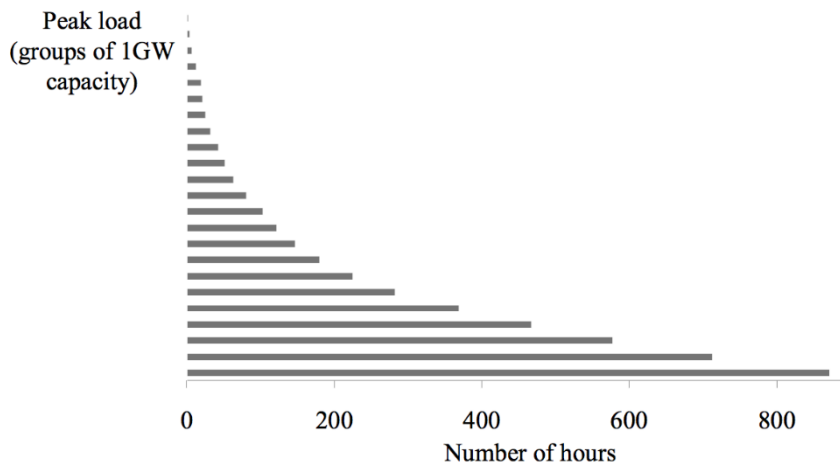

Fig. 2.23. 2009 Operating Hours per Year for Electricity Peaking Plants in MISO [2010]

There have been many studies on hydrogen futures. The results of recent studies on global hydrogen systems studies are described in Appendix C. Depending upon assumptions, one can have futures where 5 to 30% of all energy consumption goes into hydrogen production. The lower estimates assume primary use for chemical applications. The higher estimates imply hydrogen use in the transport sector or as a heat source. The relative advances in different technologies (batteries, fuel cells, biofuels, heat pumps, etc.) will determine hydrogen futures.

2.3.3.2. Ammonia

For attaining a hydrogen economy, ammonia (NH_3) has gained interest for future energy system as shown in Figure 2.24 and is regarded as one of the candidates for a hydrogen (H_2) carrier and a possible fuel for a low-carbon world due to the key properties of energy density, logistics and technical compatibility.

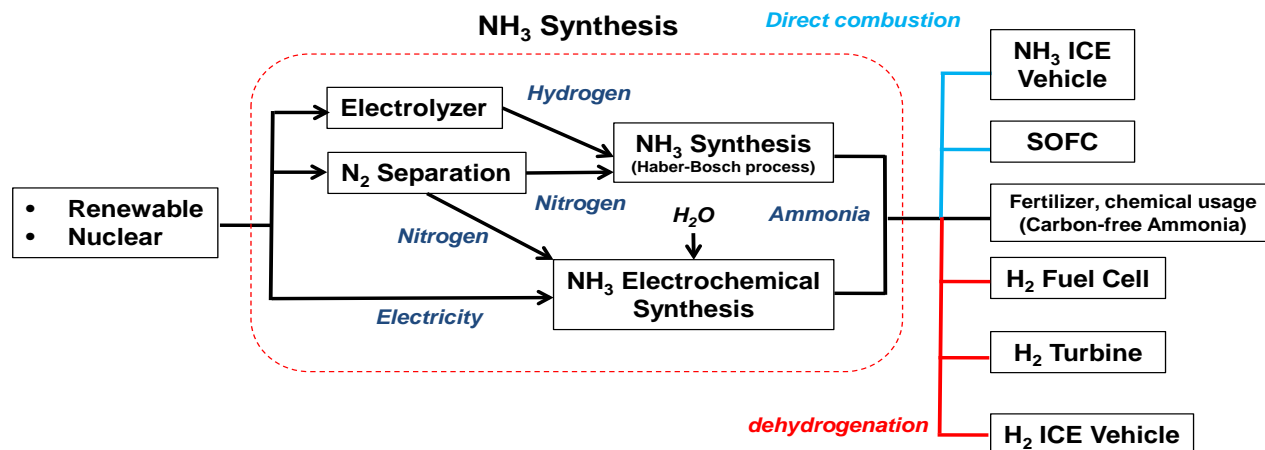

Fig. 2.24. Conceptual figure of carbon-free ammonia energy system.

First, ammonia has one of the highest hydrogen content and high gravimetric and volumetric energy densities. It has a comparable energy density similar to other major liquid fuels such as methanol and ethanol. Second, in direct combustion or reformation processes, ammonia accomplishes zero-carbon emissions and hence is categorized as carbon-free hydrogen carrier. Third, ammonia has well-developed distribution infrastructure that would support deployment of an ammonia-mediated hydrogen economy. Ammonia-based hydrogen system can avoid the massive investment otherwise needed to procure large amounts of finance and to develop a new infrastructure for hydrogen. Ammonia is stored as relatively low pressure and is easily transportable using rail, road and pipelines depending on the required quantity with a good safety record. Last, due to the research and development, ammonia is expected to be consumed in direct combustion technology such as solid oxide fuel cell (SOFC). The conversion loss can be avoided otherwise caused to dehydrogenate ammonia to yield hydrogen.

2.3.4. Liquid Hydrocarbon Fuels Production

Liquid hydrocarbon fuels are the primary fuel used in transportation because of their (1) high energy density per unit volume and mass and (2) safety in handling. The low weight and high performance of fossil-fuel power systems used in transportation is partly because these systems use atmospheric oxygen and can release the combustion products into the air. The performance of alternative systems such as batteries is much lower. Batteries contain their own oxidizer and carry their waste products from electricity production. The waste products are converted back to fuel when the battery is recharged. That results in their low performance relative to hydrocarbon fuels.

While much of the transport sector can find alternative fuels, no really credible low-carbon alternatives have been found to replace hydrocarbon fuels for applications such as aircraft and heavy trucks [Forsberg 2008]. Because liquid fuels are such a large fraction of energy demand, what replaces fossil liquid fuels is a major question for a low-carbon future and will strongly impact primary energy choices (nuclear, wind, solar, etc.) depending upon whether these fuel production processes require heat, hydrogen, or electricity

and whether the fuel production processes require constant or variable energy inputs. While we can't answer this question today, we can define the major low-carbon methods to make hydrocarbon fuels.

2.3.4.1. Biofuels

Biofuels are a major option for the United States [Armstrong, 2015] but a minor option for Japan because of the high population densities with limited land availability. Five independent studies [Dale, 2014] have found that approximately 25% of global energy demand (138 EJ/year) could be met by bioenergy to achieve a low-carbon energy sector, mostly for liquid transportation fuels. Biofuels can potentially provide a low-carbon liquid fuel option because CO₂ is extracted by plants from the atmosphere, converted to liquid fuels, burnt, and returned to the atmosphere with no net change in atmospheric CO₂ levels. The quantity of biofuel per ton of harvested biomass is strongly dependent upon the external heat and hydrogen inputs at the biorefinery and thus the potential of biofuels depends upon coupling biofuel refineries to primary energy sources—nuclear, wind and solar.

There are technical, economic, and policy challenges to achieving large scale, sustainable biofuel production. Essentially, one must redesign world agricultural systems to produce biofuels, food and animal feeds, and also provide large-scale environmental services. Agriculture is currently not designed to meet any objectives other than food/animal feed provision. Important environmental services include reducing fertilizer consumption, limiting erosion and loss of nitrogen and phosphorus to surface and groundwater, improving biodiversity, and significantly increasing carbon stored in the soil—a potentially enormous carbon sink. Increasing the carbon inventory of the soil may in fact be the lowest cost option for sequestering carbon dioxide. Done poorly, biofuels can conflict with food production, wildlife values, and other land uses, and reduce soil carbon. Thus, the future of biofuels depends as much on good policies as advancing technologies.

Central to achieving this transformation is to recognize that well over 80% of agricultural land is used to produce animal feeds, not human foods directly. Thus, there is a much wider choice of options to simultaneously increase biofuels and animal food production than would be the case if we also had to change human food consumption habits. More sustainable agricultural practices would include more double cropping, greater use of no till and conservation tillage practices, more use of perennial grasses and trees in sensitive areas, etc. These and other changes are well within the capabilities of farmers to implement—but would also require new incentive structures for farmers to change their practices, as they have done in the past.

For cellulosic or “second generation” biofuels, advances in many technologies are required [Dale 2015]. Perhaps most important are methods to convert locally-available biomass into dense intermediate commodity products that can be economically stored and shipped long distances. Creating shippable commodity biomass feedstocks enables large-scale, lower-cost biorefineries and also creates national markets for production by the most efficient, most sustainable methods feasible. Commodity cellulosic biomass feedstocks would create the environment for farmers to respond to market demand for cellulosic biofuels. Large-scale biorefineries enable efficient coupling of those refineries to nuclear reactors providing heat. This environment does not now exist. However, the cost of lignocellulosic feedstock (\$20-100/ton) is sufficiently low that biofuels are potentially competitive with fossil liquid fuels (Fig. 2.25).

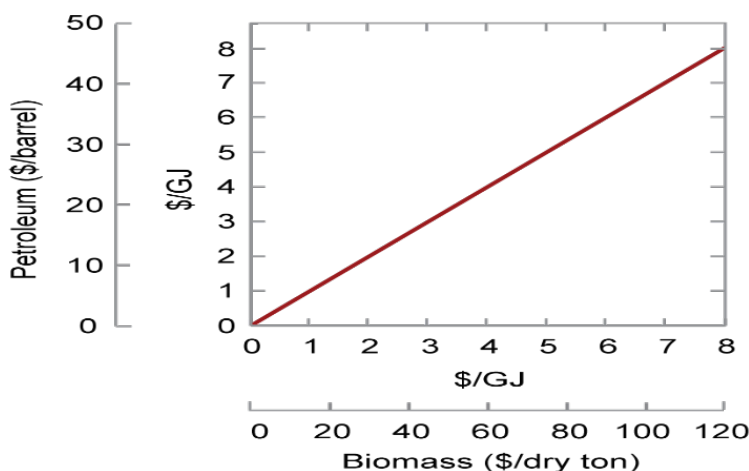

Fig. 2.25. Cost of Biomass Feedstock vs. Price of Petroleum

While there are large quantities of biomass, it is unclear if it could fully meet global demand for low-cost liquid transport fuels. The capability of biofuels to provide low-cost transport options depends upon the total demand; that, in turn, depends upon fuel efficiency, alternative fuels, and developments such as hybrid vehicles. Current estimates is that about half the liquid fuel demand is for applications (airplanes, heavy trucks) where there are few or no alternatives to liquid fuels.

In the area of biomass-to-liquid fuels conversion there are three complementary strategies for liquid transport biofuels that can strongly affect quantity of liquid fuels per ton of feedstock and net CO₂ releases to the air.

Biomass as feedstock and energy source. Biomass can be used as the feedstock for a biofuels refinery and the energy source to operate the biorefinery.

Biomass as a feedstock. The conversion of biomass into liquid fuels is energy intensive. If external sources of heat and hydrogen from nuclear, wind and solar can be provided, the liquid fuels yield per ton of biomass feedstock can be doubled with dramatically lower feedstock requirements. Table 2.4 shows the biofuels yield per ton of biomass for different processes. Processes that use more hydrogen produce more and better quality biofuels per ton of biomass. In some cases, the added hydrogen is providing over 40% of the energy in the final biofuel. In such scenarios, liquid fuels production becomes the dominate use of hydrogen with 10 to 15% of all energy consumption used to produce hydrogen for biofuels.

Table 2.4. Comparison of Options for Producing Hydrocarbon Fuels from Biomass [Holtzaple, 2015]

Platform (Chemical Process)	Yield: Kg Octane per Kg Cellulose	Efficiency	Input Energy from H ₂
Thermochemical $2.27\text{C}_6\text{H}_{10}\text{O}_5 + 1.14\text{O}_2 \rightarrow \text{C}_8\text{H}_{18} + 5.64\text{CO}_2 + 2.36\text{H}_2\text{O}$	0.310	86.0%	0%
Sugar $2\text{C}_6\text{H}_{10}\text{O}_5 + \text{H}_2 \rightarrow \text{C}_8\text{H}_{18} + 4\text{CO}_2 + 2\text{H}_2\text{O}$	0.352	92.9%	9%

Carboxylate (Kolbe Electrolysis) $1.67\text{C}_6\text{H}_{10}\text{O}_5 + 5\text{H}_2 \rightarrow \text{C}_8\text{H}_{18} + 2\text{CO}_2 + 4.33\text{H}_2\text{O}$	0.422	89.7%	23.4%
Carboxylate (2° Alcohol) $1.5\text{C}_6\text{H}_{10}\text{O}_5 + 7\text{H}_2 \rightarrow \text{C}_8\text{H}_{18} + \text{CO}_2 + 5.5\text{H}_2\text{O}$	0.469	88.2%	32.3%
Carboxylate (1° Alcohol) $1.33\text{C}_6\text{H}_{10}\text{O}_5 + 9\text{H}_2 \rightarrow \text{C}_8\text{H}_{18} + \text{CO}_2 + 6.67\text{H}_2\text{O}$	0.528	86.8%	40.8%

Biomass for low-carbon bio and fossil liquid fuels production. Many of the biomass-to-liquid-fuel processes produce nearly pure CO₂ as a byproduct that could be sequestered underground. The sequestration of this CO₂ would allow burning an equivalent amount of fossil liquid fuel to be used with no net change in atmospheric CO₂ levels. This option may provide the lowest cost option for a zero-carbon liquid fuels future.

Today carbon dioxide capture and sequestration from fossil plants is expensive and energy intensive—primarily because of the cost and energy requirements to recover and concentrate CO₂ from dilute stack gases. The sequestration step is relatively cheap. Certain biofuels processes produce nearly pure CO₂ and thus would have dramatically better economics for capture and sequestration of CO₂. At the same time, the cost of biomass will increase as the demand increases—meeting total liquid fuels demand using biofuels may become expensive. A more economic option for a zero-carbon liquid fuels future could be conversion of some biomass into liquid fuels, sequestration of carbon dioxide from those biofuel plants, and limited use of fossil liquid fuels. Alternatively, biofuels production with sequestration of carbon dioxide could be used to reduce atmospheric carbon dioxide levels if that becomes a priority.

In summary, this renewable energy source raises the most complex policy questions.

- *Land use.* How much global land area should be reserved for other human activities and the environment versus used to produce biomass for energy?
- *Carbon sequestration.* Should harvested biomass be used for carbon capture from the atmosphere with carbon sequestration to reduce the atmospheric concentrations of carbon dioxide? However, such options significantly reduce energy output per unit mass of biofuels.
- *Liquid fuels.* Should available biomass be reserved to produce liquid fuels for the transport sector where there are few good alternatives for fossil liquid fuels or be used as a general stationary energy source to provide dispatchable energy?

Because of limited global land area and limited planetary biomass, we conclude that biomass will be important for liquid fuels production but is not likely to play globally a significant role as a stationary energy source to provide dispatchable energy. Land use, carbon sequestration and liquid fuels are likely to be higher priority uses for biomass.

2.3.4.2. Liquid Hydrocarbon Fuels from Air and Ocean Seawater

The combustion of fossil fuels produces carbon dioxide and water that is initially released to the atmosphere. Ultimately most of the water and carbon dioxide resides in the oceans. There is the option to

reverse the process—extract carbon dioxide from the atmosphere or ocean, produce hydrogen from water, and convert the carbon dioxide and hydrogen to a hydrocarbon fuel. This option can provide an unlimited source of liquid fuels with no net release of carbon dioxide to the environment. It is an energy intensive process where the final hydrocarbon fuel will be more expensive than electricity.

Liquid Hydrocarbon Fuels from Carbon Dioxide Gas

Crucial decarbonization options such as CCS are not being implemented as quickly as it could be, and therefore, more attention is being paid on alternative technologies for achieving 2-degree target. One such technology which have been investigated is direct air capture (DAC) [Socolow, 2011] as shown in Fig 2.26 and Fig 2.27. DAC is defined as the direct extraction of carbon dioxide from the atmosphere with chemicals and incorporates a system which selectively captures CO_2 when ambient air passes through a chemical sorbent, and the captured CO_2 can be released for sequestration or recycle. Thus, DAC could potentially contribute to achieve zero or net negative emissions if used together with carbon disposal technology, and to produce renewable synthetic fuels or gases from recovered CO_2 and H_2O .

From a technical aspect, a DAC plant consumes low-carbon electricity and heat to capture CO_2 from ambient air. Carbon-intensive power and heat are not allowable options for DAC operation, because CO_2 emissions associated with those power and heat sources may surpass the captured CO_2 with DAC. DAC can be potentially compatible with power grid under large-scale penetration of renewable energy, because the low-carbon electricity consumed for DAC can be supplied from the massive renewable and the low-carbon heat can be produced as well from FIRES converting excessive renewable electricity into stored heat. DAC is not currently an economically available option for achieving strict carbon reduction target and significantly higher carbon price is required to make it commercially viable.

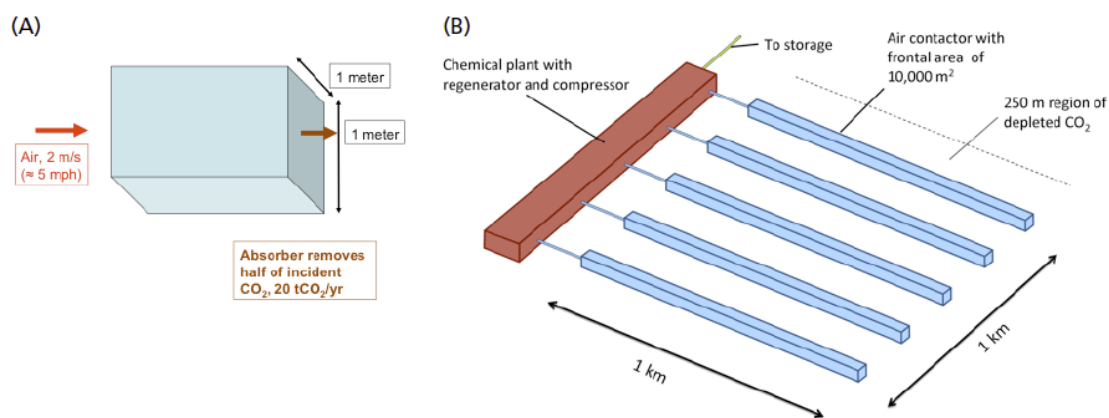

Figure 1.2. Schematic representations of A) a 1 m^2 intake area contactor capturing 20 tCO_2/yr , and B) a facility for capturing 1 MtCO_2/yr . The facility in B consists of five structures, each 10 meters high and 1 km long, and could collect 1 MtCO_2/yr if air passed through at 2 m/s and 50% of the CO_2 were collected. The structures are spaced 250 meters apart, and the footprint of the system is roughly 1.5 km^2 . Approximately six of these systems would be required to compensate for the emissions of a 1 GW coal plant. Buildings not to scale.

Fig 2.26. Schematic figure of direct air capture (DAC). [Socolow, 2011]

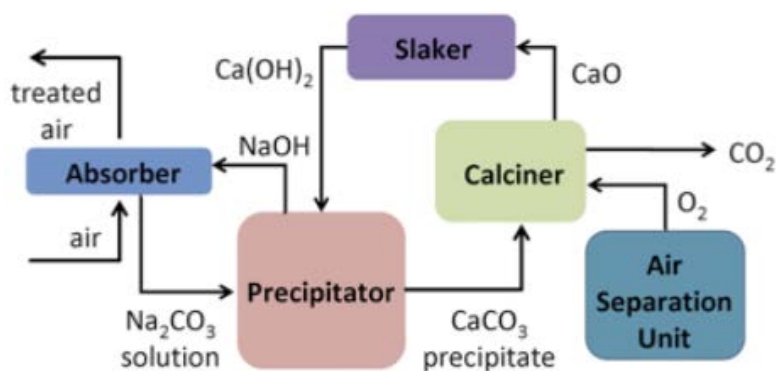

Fig 2.27 Schematic figure of a plant for CO₂ capture from air that uses NaOH as the absorber.
[Socolow, 2011]

Liquid Hydrocarbon Fuels from Ocean Seawater

The United States Navy [Willauer, 2014; Willauer, 2017] is developing a method to produce hydrocarbon fuels from seawater by using an electrolytic cell that yields hydrogen, oxygen and carbon dioxide from seawater. The carbon dioxide and hydrogen are then chemically combined to produce jet and diesel fuel—with byproduct production of oxygen.

The navy interest is that it would enable a nuclear-powered ship at sea to make fuel for aircraft and non-nuclear ships and thus eliminate the primary logistics challenge of the navy—providing liquid fuels for the fleet. The same technology, if successfully developed, could provide liquid hydrocarbon fuels for a low-carbon world and would in such a world be the largest consumer of electricity. The process is in the pilot plant stage of development with a one-gallon per minute prototype module expected to startup this year that should begin to provide some understanding of the economics.

The ocean contains about 100 mg/liter of carbon dioxide with 175 times more carbon dioxide than the atmosphere. On a weight per unit volume basis, the carbon dioxide in the ocean is about 140 times more concentrated than in air. However, 96 to 97% of the carbon dioxide is chemically bound up as bicarbonate and only 2 to 3% in the form of dissolved carbon dioxide gas that can be easily removed from seawater. The requirement to recover carbon dioxide from seawater is to break the carbonate complex.

An electrolytic catalytic exchange membrane (E-CEM) process is being developed where the electrolytic cell is fed seawater and produces carbon dioxide, hydrogen, and oxygen. The hydrogen and carbon dioxide are then used to produce hydrocarbon fuels using processes similar to indirect commercial coal-to-liquid-fuels processes. The E-CEM module (Fig. 2.28) consists of a three-compartment electrolytic cell where the left cell produces oxygen and the right cell produces hydrogen and sodium hydroxide. Hydrogen ions go through a membrane and enter the central compartment from the anode while sodium ions go through the other membrane to the cathode. The seawater in the central compartment is acidified with its pH going from pH of 8 to 6. This change in pH causes the bicarbonate in the seawater to be converted to carbon dioxide gas that separates from the seawater. The acidified seawater and water from the cathode compartment containing sodium hydroxide are recombined to yield seawater at its

normal pH but without carbon dioxide. This stream is returned to the ocean.

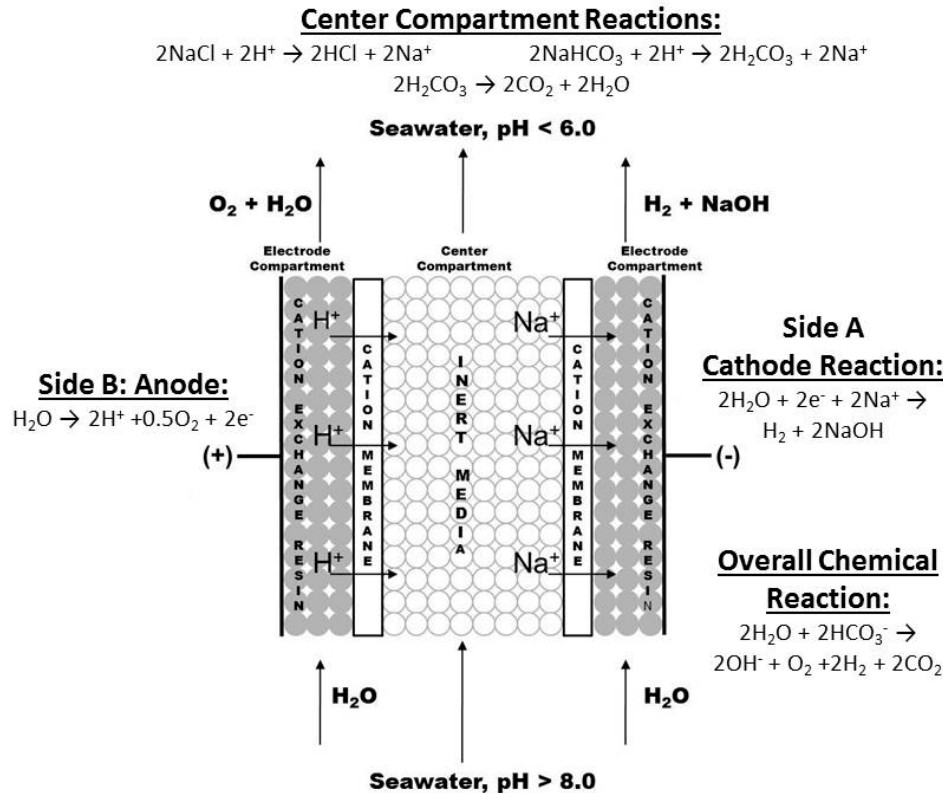

Fig. 2.28. Electrolytic Catalytic Exchange Membrane Module to Recover Carbon Dioxide, Hydrogen, and Oxygen from Seawater

The economics depend upon the cost of electricity and the efficiency of the E-CEM module. The goal for the E-CEM module is for an efficiency similar to current water electrolysis cells; but it is too early in the development cycle to assess if this goal can be reached. This process is the reverse of today's liquid fuels combustion process and would be capable of producing unlimited liquid fuels assuming sufficient electricity.

2.4. Gen-III+/IV Reactor Technologies

Commercial nuclear reactors have been developed to produce base-load electricity—a single product. The economic criteria for comparing reactors has been leveled cost of electricity—the cost of electricity if the reactor operates at full power. The economic criteria change if the product is variable electricity, high-temperature heat or hydrogen. We do not have a good understanding of the requirements for a low-carbon world. As a consequence we do not fully understand the implications for advanced reactor development. We discuss some of the implications but this is not an inclusive set of recommendations for the path forward.

Historically research and development on advanced reactors has been based on (1) economics of base-

load electricity, (2) sustainability involving fuel cycles and (3) safety. Our thesis is that if nuclear energy is to fully contribute to a low carbon world a fourth criteria is required in developing advanced reactors—dispatchable energy to electricity and heat markets. The addition of this criteria will change research, development and deployment priorities.

As important as the reactor development are the required power cycles, heat storage, and energy delivery systems that have been discussed. These include Brayton power cycles, multiple heat storage technologies that directly couple to reactors, FIRES, and the technologies for long-distance transport of heat as a commodity.

2.4.1. Light Water Reactors

LWRs are the dominate reactor type and will be for the next several decades. For LWRs in a low-carbon world, the new areas of R&D will be in the steam cycles to enable coupling to heat storage systems, the heat storage systems and providing steam to multiple customers. These are outside the reactor core. Some LWRs do provide steam but generally the starting point has been a reactor and power cycle designed for base-load electricity where the minimum changes were made for off-site steam sales. There has been recent work by Ikegawa (2017) and others to optimize LWR steam systems for base-load reactor operations with variable outputs of electricity and steam at different pressures for different markets.

2.4.2. High-Temperature Reactors

The world requires massive quantities of high-temperature heat that is today provided by burning of fossil fuels. In a low-carbon world, the choices are to produce that high-temperature heat using electricity, burning hydrogen or an equivalent synthetic fuel, or a high-temperature reactor (HTR). The first two options imply converting work to heat, the most valuable form of energy into a less valuable heat—a process that is likely to imply high costs. As a consequence, any low-carbon future creates large incentives to develop and commercialize HTRs.

There are several classes of HTRs with the common characteristic of producing high-temperature heat but different fuels, coolants, and fuel cycles.

- *High-Temperature Gas-Cooled Reactors (HTGRs)*. These reactors use solid fuel and helium as the coolant. They are the most developed technology with the first HTGRs built in the 1970s. There are currently test reactors in Japan and China. China is expected to startup two larger HRGRs in the next two years.
- *Fluoride-salt-cooled High-temperature Reactors (FHRs)*. This reactor concept uses HTGR fuels and a clean liquid salt coolant. The concept is about 15 years old and has received much attention because it is designed to efficiency couple to nuclear Brayton cycles by delivering heat in the 600 to 700°C range. Nuclear Brayton power cycles enable a base-load reactor to produce variable electricity for the grid. Because the FHR uses HTGR fuel, it has many of the safety

characteristics of the HTGR and takes advantage of the development of HTGR fuel.

- *Molten Salt Reactors (MSRs)*. In this reactor, the fuel is dissolved in the coolant. Two small test reactors were built in the United States in the 1950s and 1960s. There has been renewed interest in MSRs because (1) advancing technologies in several fields have addressed some of the earlier challenges and (2) the discovery that one variant (molten chloride fast reactor) has the potential to be a breed-and-burn fast reactor—a fast reactor with a once-through fuel cycle and efficient use of uranium fuel.
- *High-temperature Lead-Cooled Fast Reactors (LFRs)*. This is a solid-fuel reactor that uses lead or a lead-bismuth mixture as the coolant. Lead-cooled reactors were originally developed and deployed by the Russians for submarine reactors. The challenge has been metal corrosion that determines peak operating temperatures and has limited peak allowable temperatures. Recent work has identified several potential methods to address the corrosion challenge that if successful would enable a high-temperature LFR.

The HTGR is the near-term HTR option. China is building two commercial demonstration reactors that will become operational in the next year or two. They are examining several commercialization options including retrofitting existing coal plants where the coal boiler would be replaced by HTGRs but the remainder of the station (steam turbine, generator, cooling towers) would be coupled to the reactors—a strategy to quickly reduce air pollution levels in China while minimizing the cost to build a power station. If that occurs, the Chinese will build a very large number of HTGRs that will drive down capital costs and potentially open markets worldwide to the HTGR.

There are plans in Japan and the United States to build commercial demonstration HTGRs. The United States was proceeding toward building the Next Generation Nuclear Plant (NGNP) that is designed to provide heat to the industrial sector. That has been delayed because the unexpected development of natural gas fracking decreased natural gas prices in the United States by a factor of three. These very low natural gas prices are currently limited to the United States and Canada. The process to convert natural gas into liquefied natural gas (LNG) for export approximately doubles the price of natural gas shipped to other countries and thus results in significantly higher energy prices in other countries.

One important non-technical conclusion (Ryskamp 2003) from the development of the NGNP was a different perspective on safety. To provide high-temperature heat, the NGNP has to be sited close to the industrial facilities. There are very large capital investments associated with many of these industrial facilities and protection of investment becomes a major concern. That resulted in a design goal of no offsite consequences in the event of an accident with a very small NGNP site collocated with the industrial site. In effect, the large-scale use of nuclear closely coupled with industrial sites brings with it a separate set of requirements beyond just producing high-temperature heat.

Last, the recent discovery in Japan that an HTGR may have the ability to rapidly vary electricity production while the reactor fission process remains unchanged (constant core power output) may have large economic implications. The rapid capability to store energy and stabilize the electricity grid can partly replace gas turbines, electric storage batteries, and pumped hydro facilities. Those cost savings imply higher value for such an HTGR. .

2.5. Small Modular Reactors

The OECD/NEA report “Small Modular Reactors: Nuclear Energy Market Potential for Near-Term Deployment” (2016) discussed the results of optimum energy mix depending on increased share of intermittent renewables by the use of NEA model and concluded that the share of SMR increases as the share of intermittent renewables increases in the grid because SMRs are most competitive at load factors of 60-85% and replaces base load plants (coal and large scale nuclear). Certainly new SMRs can be designed for more flexibility (load following operation) in the grid as compared with existing LWR fleet. However, SMRs still maintain capital intensive nature and low capacity factor leads to poor economic performance. Economics of SMR, as compared with economics of scale in large units, depends on series production, streamlined supply chain and controlled increase of O&M cost in spite of increased per-MWe-number of components and operators, which market is yet to see the realities.

2.6 Observations and Recommendations on Technology Options

Man for a quarter million years has met his energy needs by burning storable biomass and fossil fuels. The characteristic of the technology, be it in the form of a cooking fire or a combined-cycle gas turbine, is that these energy systems have low-capital costs and high operating costs (fuel). This implies low costs to provide dispatchable energy to match demand because the capital costs associated with the cooking stove or gas turbine at part load are small—it’s not required to operate at full capacity. The fuel costs vary with demand.

Nuclear, wind, and solar power systems have high capital costs per unit of energy produced and low operating costs. Operating these facilities at low capacity factors implies much more expensive energy. Their full-capacity output does not match the variable energy needs of man. If their output is half of what they are capable of producing, energy costs almost double. The challenge therefore is how to match the mismatch between production and demand.

There are fundamental differences between nuclear and mainline renewables (wind and solar): (1) nuclear produces heat whereas the mainline renewables produce electricity and (2) nuclear is a dispatchable energy system whereas mainline renewable output depends upon variable wind and solar inputs. These differences imply different technologies for storage and different options to match energy production with demand. Because heat storage is less expensive than electricity (work) storage, it creates the option that a reactor operating at base-load can provide variable dispatchable energy to society—an enabling technology for an economic low-carbon energy system and potentially the enabling technology for larger scale use of wind and solar by addressing the non-dispatchability challenge of mainline renewables. Humans are only beginning the transition to a low-carbon system and thus the perspective herein is a snapshot in time of future nuclear technology options.

The central recommendation is the need to develop multiple technologies to provide dispatchable energy. Nuclear energy is central in that role because of two characteristics: (1) it is dispatchable, not dependent upon wind and solar external inputs, and (2) it generates heat. Heat and work (electricity) are the fundamental forms of energy and provide different pathways to dispatchable energy. Heat storage has

the potential to provide energy storage costs at a small fraction of electricity storage technologies with major implications on the cost of energy for society.

References for Chapter 2

Andreades, C, R. O. Scarlat, L. Dempsey, and P. F. Peterson, June 2014, “Reheating Air-Brayton Combined Cycle Power Conversion Design and Performance Under Normal Ambient Conditions”, *J. of Engineering for Gas Turbines and Power*, **136**.

Andreades, C. et al., September 2016, “Design Summary of the Mark-I Pebble-Bed, Fluoride-salt-cooled, High-Temperature Reactor Commercial Power Plant”, *Nuclear Technology*, **195**, 223-238.

Armstrong, R., C. Forsberg, and M. Golay, 2015. “The MIT Low-Carbon Energy Economy Workshop”, MIT Energy Initiative, Cambridge, Massachusetts, May 26-27, 2015

Bistline, J. E., 2017. “Economic and Technical Challenges of Flexible Operations Under Large-Scale Variable Renewable Deployment”, *Energy Economics*, **64** 363-372

California ISO, 2016, *What the Duck Curve Tells Us About Managing a Green Grid*, https://www.caiso.com/Documents/FlexibleResourcesHelpRenewables_FastFacts.pdf

Dale, B., et al., 2014. “Take a Closer Look: Biofuels Can Support Environmental, Economic and Social Goals,” *Environmental Science and Technology*, **48**, 7200-7203.

Dale, B., et al, 2015. “Lignocellulosic Biofuels,” *Chemical Engineering Progress*, 33-64, March

Denholm, P., Margolis, R. M., 2007. “Evaluating the Limits of Solar Photovoltaics (PV) in Traditional Electric Power Systems,” *Energy Policy*, **35**, 2852-2861.

Esteban M. et al., 2010, Methodology to estimate the output of a dual solar-wind renewable energy system in Japan, *Energy Policy*, **38**, pp.7793-7802.

Fathi, N., et al., June 26-30, 2016. “Nuclear Systems for a Low-Carbon Electrical Grid”, *Proc. 24th International Conference on Nuclear Engineering, ICONE24*.

Forsberg, C., 2007. “Future Hydrogen Markets for Large-Scale Hydrogen Production Systems,” *International Journal Hydrogen Energy*, **32**, 431

Forsberg, C., December 2008. “Nuclear Energy for a Low-Carbon-Dioxide-Emission Transportation System with Liquid Fuels”, *Nuclear Technology*, **164**

Forsberg, C., 2013, “Hybrid Systems to Address Seasonal Mismatches Between Electricity Production and Demand in Nuclear Renewable Electricity Grids,” *Energy Policy*, **62**, 333-341.

Forsberg C.W, et. al, 2016, Joint MIT-Japan White Paper: Compatibility of Nuclear and Renewables with Grid Stability, Economics, and Deregulation, <http://ipc.mit.edu>; <http://www.esl.t.u-tokyo.ac.jp/reports-e.html>.

Forsberg, C. and P. F. Peterson, October 2016 “Basis for Fluoride-Salt-Cooled High-Temperature Reactors with Nuclear Air-Brayton Combined Cycles and Firebrick Resistance-Heated Energy Storage”, *Nuclear Technology*, **196**, 13-31.

Forsberg, C. P. F. Peterson, P. McDaniel, and H. Bindra, “Nuclear Combined Cycle Gas Turbines for Variable Electricity and Heat Using Firebrick Heat Storage and Low-Carbon Fuels”, *Proc. International Congress on Advanced Nuclear Power Plants (ICAPP 2017)*, April 24-28, 2017, Fukui and Kyoto, Japan

Forsberg, C. et al., June 2017a. Proceedings of the Workshop Light Water Reactor Heat Storage for Peak Power and Increased Revenue, Massachusetts Institute of Technology, <http://energy.mit.edu/2017-canes-light-water-reactor-heat-storage-for-peak-power-and-increased-revenue>

Forsberg, C. et al. June 2017b. “Converting Excess Low-Priced Electricity into High-Temperature Stored Heat for Industry and High-Value Electricity Production”, *Electricity Journal*, <https://doi.org/10.1016/j.tej.2017.06.009>

Haratyk, G., Nuclear Asset Shutdown Under Uncertainty, 2017, PhD Thesis, Department of Nuclear Science and Engineering, Massachusetts Institute of Technology, Cambridge, Massachusetts.

Hirth, L., 2013, “The Market Value of Variable Renewables, the Effect of Solar Wind Power Variability on Their Relative Prices,” *Energy Economics*, **38**, 218-236.

Hirth, L., 2015, “The Optimal Share of Variable Renewables: How the Variability of Wind and Solar Power Affects their Welfare-Optimal Development,” *The Energy Journal*, **36** (1).

Holtzapple, M. et. al., 2015. “Producing Biofuels via the Carboxylate Platform”, *Chemical Engineering Progress*, 52-57, March.

Ikegawa, T. et. al., 2017. “Conceptual Design of Heat Transfer System for the Co-generation Small-to-Medium Sized BWR,” Paper 17332, *Proceedings of the International Congress on Advances in Nuclear Power Plants*, Fukui and Kyoto, Japan

KAIROS Power, 2017, www.kairos-power.com

Komiyama, R., Fujii Y., 2014. Assessment of Massive Integration of Photovoltaic System Considering Rechargeable Battery in Japan with High Time-Resolution Optimal Power Generation Mix Model. *Energy Policy*, **66**. 73-89. DOI: 10.1016/j.enpol.2013.11.022.

Massachusetts Institute of Technology, 2015, *The Future of Solar Energy*.

Mehos, M., Turchi, C., Jorgenson, J., Denholm, P., Ho, C., Armijo, K., 2016. On the path to Sunshot: Advancing Concentrating Solar Power Technology, performance and dispatchability, NREL/TP-5500-65688, SANDIA-2016-2237R

Mills, A. and R. Wiser, *Changes in the Economic Value of Variable Generation at High Penetration Levels: A Pilot Case Study of California*, Lawrence Berkeley National Laboratory, LBNL-5445E, June 2012.

O'Brien, J. E., et. al., February, 2010. High Temperature Electrolysis for Hydrogen Production from Nuclear Energy – Technology Summary, Idaho National Laboratory, INL/EXT-09-16140

OECD/NEA, 2016, Small Modular Reactors: Nuclear Energy Market Potential for Near-Term Deployment
Office of Energy Efficiency and Renewable Energy, U.S. Department of Energy, Sunshot Initiative Goals

Randolph, B, McDonald, N. D., M Kar, and T. He., 2017. Electrochemical Hydrogen Production? Chapter 27, 897 in *Springer Handbook of Electrochemical Energy* (Eds. K. Swider-Lyons and C. Breitkopf, Springer

Ryskamp, J. M. et. al., September 2003. Next Generation Nuclear Plant—High Level Functions and Requirements, INEEL/EXT-03-01163, Idaho National Engineering and Environmental Laboratory.

Safa, 2012. “Heat Recovery from Nuclear Power Plants,” *Electrical Power and Energy Systems*, **42**, 553-559

[Schmidt, O., Hawkes, A., Gambhir, A., Staffell, I., July 10, 2017. The future cost of electricity storage based on experience rates, *Nature Energy*, 2, Article 17110.](#)

Socolow, R. et al. 2011. “Direct Air Capture of CO₂ with Chemicals,” The American Physical Society, <https://www.aps.org/policy/reports/assessments/upload/dac2011.pdf>

Stack, D. et al., 2016, “Market Assessment of Firebrick Resistance Heated Energy Storage (FIRES) – Avoiding Wind and Solar Electricity Price Collapse to Improve Nuclear, Wind, and Solar Economics,” *Proc. 2016 International Congress on the Advances in Nuclear Power Plants (ICAPP 2016)*, April 17-20, San Francisco, California, U.S.A.

Stack, D., 2017, Conceptual Design and Performance Characteristics of Firebrick Resistance-heated Energy Storage for Industrial Heat Supply and Variable Electricity Production. MS Thesis, Department of Nuclear Science and Engineering, Massachusetts Institute of Technology.

Tokyo Electric Power Company website, Retrieved May, 2015:

<http://www.tepco.co.jp/en/forecast/html/index-e.html>.

Willauer, H.D., et. al., 2014, “Feasibility of CO₂ Extraction from Seawater and Simultaneous Hydrogen Gas Generation Using a Novel and Robust Electrolytic Cation Exchange Module Based on Continuous Electrodeionization Technology”, *Industrial and Engineering Chemistry Research*, **53**, 12192-12200, <http://dx.doi.org/10.1021/ie502128x>.

Willauer, H.D. et. al., 2017. “Development of an Electrolytic Cation Exchange Module for the Simultaneous Extraction of Carbon Dioxide and Hydrogen Gas from Natural Seawater”, *Energy and Fuels*, **31**, 1723-1730, <http://dx.doi.org/10.1021/acs.energyfuels.6b02586>.

Yan, X. L., et al., 2012. Study of a nuclear energy supplied steelmaking system for near-term application/ *Energy* **39**, 154-165

3. Market Mechanism Options

3.1. Markets

Markets are a mechanism to minimize the economic costs to society of a particular good or service. The driving force is the maximization of profit of the market participants. By definition, the market does not consider externalities such as environment and security of energy supply that are important to society. The question is then how to take advantage of the efficiency of markets in minimizing the economic costs of electricity while meeting the other goals of society such as sustainable development goals to bridge the gap between development and environment and to enable development that meets the needs of the present without compromising the ability of future generations to meet their own needs.

To address this question, we undertook studies [HARATYK, 2017a; HARATYK, 2017b] to define options for adjusting market rules for electricity sales to meet societal goals with the goal of minimizing total cost of electricity while meeting social goals.

3.2. Different U.S./Japan Challenges

The U.S. and Japan have very different challenges for the next 10 to 15 years.

Electricity Challenges for the United States

In the United States, as described in Chapter 1, the price of natural gas has dropped dramatically. As a consequence, wholesale electricity prices (Fig. 3.1) for the last 10 years have been decreasing everywhere in the United States. Natural gas has replaced coal as the primary fuel used to produce electricity. The development of renewables has been driven by state and federal subsidies since renewables are uneconomic in most locations, despite a spectacular decrease in capital costs over the last ten years [Lazard, 2016].

Commercial nuclear reactors have consequently seen a collapse in their revenue. Natural gas reduces average wholesale prices. Subsidized renewables drives prices in some locations to near zero and sometimes negative at times of high wind and solar output (Chapter 2). Tens of gigawatts of nuclear capacity have become unprofitable and are at risk of retiring prematurely in the U.S. [Haratyk, 2017a].

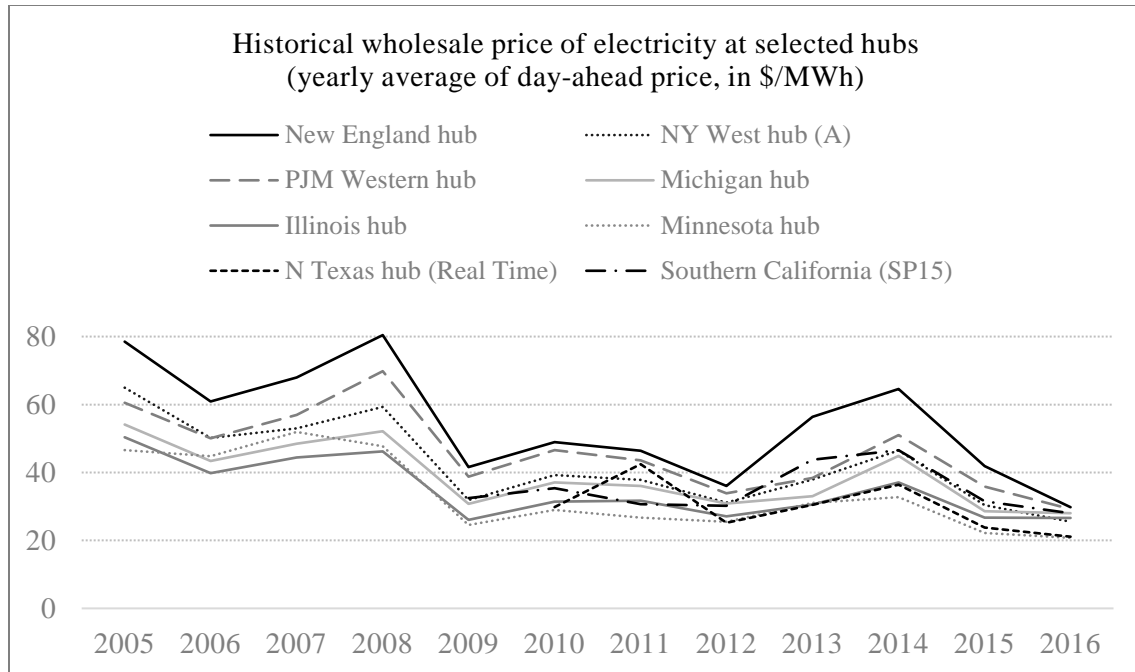

Fig. 3.1. U.S. Wholesale Electricity Prices versus Time

For the United States, continued operation of the existing nuclear plants is the lowest-cost low-carbon option (significantly less expensive than the subsidies to renewables) but some nuclear plants are closing to be replaced by natural gas combined-cycle plants. There is a larger strategic challenge—the entire energy system is moving to natural gas. If natural gas prices increase or is restricted to limit greenhouse gas emissions, it will be very difficult and very expensive to move off natural gas. Short-term unprofitability closes nuclear plants that are decommissioned, creating long-term economic and environmental risks.

Electricity Challenges in Japan

As was discussed in Chapter 1, challenges in electricity sector includes those arising from deregulation (which makes new nuclear build very difficult under unbundling of Utilities), tariff increases for subsidies to supply-contingent intermittent electricity, the cost of additional import of oil/gas to recoup deficit of nuclear electricity production, and supply security by reduced share of domestic or quasi-domestic generation sources. Supply security has different elements; avoiding risk of a) interruption of supply by political reason, and b) shielding from fuel price volatility. Japan's energy self-sufficiency rate is, given a small number of nuclear units had resumed operation, currently 6%, ranked 33rd among 34 OECD countries. Not only low self-supply, geological distribution of import and its fuel mix are alarming due to vulnerability to political interruption and price volatility.

How can we quantify security value to enable level playing field by including security value in planning power generation portfolio? Setting the above a) aside, the James A. Baker Institute of Rice

University, with support from TEPCO, assessed this value using portfolio theory and found that the security value of nuclear power under these scenarios to range from about 21% to about 58% of the capital cost of constructing a nuclear power plant in Japan by assuming a set of price fluctuation cases.[Baker Institute, 2004]. Coupled with environmental value of power generation with low carbon footprint, quantification of security value enables comparison of costs of different power generating sources by including those which future generation will have to bear, namely externalities.

Japan is starting discussion of review and, if necessary, amend its Strategic Energy Plan, which was mandated by the Basic Act on Energy Policy (2002) and need review/amendment in three years. The previous revision was made in 2014. Japanese Government is supposed to deliberate on Energy Policy in light of the current status and projection as well as three policy goals (defined in the Basic Law as Stable Supply, Environmental Compatibility, and Use of Market Mechanisms) with the support of a number of experts meetings, and report to the Diet after being endorsed by the Cabinet.

Given the mandate to shift to a low-carbon economy amid various challenges including aging nuclear power plants, difficulty of new nuclear build by to-be-unbundled Utilities coupled with negative perception of nuclear, deteriorating energy supply security and increasing share of intermittent renewables, the development of a new framework is very challenging. Market mechanisms already being discussed by advisory committees or sub-committees include capacity markets and base load markets (see Section 3.3.5). Given slow progress of restart of idle nuclear power plants and achievement target of 20-22% share of nuclear in electricity supply in 2030, it is foreseen that New Nuclear Build and relevant enabling mechanism could be one of the focal areas of discussion in this new framework.

3.3. Mechanisms to Modify Market Behavior

Wholesale and capacity markets are designed to improve the operational and economic efficiency of the power system. They achieve this goal by adequately “pricing energy and capacity, taking into account the operational needs and physical constraints of the dynamics of the transmission system, and providing transparent signals for investment and retirement of resources” [FERC (Federal Energy Regulatory Commission), 2017]. Long-term policy objectives, and in particular environmental (carbon) considerations are not valued in deregulated markets. The cost of carbon damage is an externality. To a lesser extent, one can argue that the security of supply (fuel security) is also an attribute that is not appropriately valued by competitive markets, as demonstrated by the fuel shortage that took place in the 2013-14 Polar Vortex in the U.S. that almost collapsed part of the electricity grid.

The zero-emission and reliability attributes of nuclear power are therefore not valued in today’s U.S. and Japan markets. Nuclear suffers a comparative disadvantage with fossil-fuel power sources, which causes its premature retirement when fossil fuel prices drop and electricity demand stalls. This is the phenomena we observe today in the United States (See Chapter 1).

In this context, the reconciliation of long-term policy objectives with competitive markets requires modifying market rules [Forsberg et al., 2016]. This section focuses on possible adaptations of wholesale and capacity market that would benefit existing and new nuclear power plants.

3.3.1 Carbon price

Putting a price on carbon would capture the externality of environmental and societal damage caused by carbon emission [I.J. Perez-Arriaga, 2013]. Two systems are generally proposed for carbon price: a carbon tax or a cap & trade system. The carbon tax lets the regulator control the price level, with the risk of over- or under-shooting the emission targets. The cap & trade system relies on markets. The emission targets are set by the regulator who grants credits, which are then traded between generators. In the second system, the difficulty lies in the initial allocation of the credits.

Carbon pricing is a very efficient measure to achieve carbon emission reduction at a minimal cost and is technology-neutral. It favors low-carbon generators at the expense of the carbon-intensive ones, such that the current “out-of-the-market” subsidies to clean generators are no longer justified. It leaves room for innovative clean technologies to enter the market and displace the most polluting generators. However, putting a price of carbon is a challenge. One of the major obstacles is the increase in the energy price resulting from the insertion of the cost of carbon, especially if it applies to all sectors of the economy including transportation. The price of goods would increase, which would hurt the economy in the short and medium term, even though the long-term damages are minimized on the long run. If carbon pricing is implemented unevenly on a given territory, the markets that adopt it face a competitive disadvantage with respect to the other markets because their products become pricier.

An intermediate approach was proposed by NEPOOL (The New England Power Pool), an association of the market participants of ISO (Independent System Operator)-New England [Exelon, 2016]. It consists in adding the cost of carbon to the bids of the market participants, for calculation in the resource dispatch algorithm. Low carbon technologies like nuclear would benefit from a higher price of electricity, and low-carbon subsidies could be eliminated. An important element of the mechanism is the re-allocation of carbon cost: carbon-emitting generators that are called and dispatched would compensate the ISO for their emissions. The proceedings would then be allocated to the load serving entities (i.e. the consumers) to lower their energy bill. This mechanism partially alleviates the burden of carbon pricing to the consumer. This carbon price could be added rapidly to an already-existing ISO that controls the dispatch algorithm. The carbon price could be small at the beginning and progressively increased. The out-of-the-market subsidies would reduce progressively to ensure a smooth transition and give market agents time to adapt.

Table 3.1 illustrates the hypothetical outcome of a carbon price that would be applied to the Midwest and Mid-Atlantic regions of the United States. We use a simple economic dispatch model, validated against historical generation mixes and prices. Simulation shows that a moderate carbon price of \$10 / MT CO₂ would provide extra revenues to the nuclear plants equal to \$7.2 and \$8.4/ MWh for the Midwest and Mid-Atlantic respectively. This would be enough to prevent most nuclear closures. By allocating the cost of carbon to coal-, gas- and oil-fired generators, the price increase for the consumers would only be \$2.0 and \$4.6/ MWh respectively.

Table 3.1 – Putting a price on carbon lowers CO₂ emissions and increases the wholesale price of electricity, which would benefit nuclear plants. The price increase for consumer could be partly alleviated by charging the polluters for the cost of carbon damage (simulation results obtained with 2015 energy mix).

	Carbon price (\$/MT CO ₂)	0	10	20	30	41.2 (EPA social cost of carbon)
Midwest	Emissions (MM MT CO ₂)	430.93	360.85	272.32	258.84	258.57
	Wholesale electricity price (\$/MWh)	26.9	+7.2	+14.4	+23.1	+33.2
	Consumer price w/ rebate (\$/MWh)	26.9	+2.0	+6.6	+12.0	+17.9
Mid-Atlantic	Emissions (MM MT CO ₂)	271.90	263.15	263.00	262.99	262.99
	Wholesale electricity price (\$/MWh)	31.8	+8.4	+16.9	+25.3	+34.8
	Consumer price w/ rebate (\$/MWh)	31.8	+4.6	+9.2	+13.8	+18.9

3.3.2. Direct financial support: FIT, CfD, ZEC

Subsidies are the most direct way to value a specific attribute and maintain or expand a certain particular generation resource. They are the most popular form of policy support, together with tax credits. Subsidies can take different name depending on the mechanism – Feed-in-Tariffs (FIT), Feed-in-Premiums (FIP), Contract-for-Differences (CfD), Zero-Emission Credits (ZEC), etc. – but in the end they result in an additional revenue for the targeted generator. They generally take the form of payment for the electricity supplied to the grid from a given technology or plant, and are expressed in USD or JPY /MWh.

FITs have been a common method of policy support for wind and solar PV technologies at the beginning, but were later replaced in Europe by FIPs with competitive bidding. Premiums are a payment that is added to the wholesale electricity sale revenue rather than a substitutive tariff. Note that subsidies through competitive bidding require multiple independent agents to be effective.

3.3.2.1. FIT-CfD

A CfD can be seen as a long-term power purchase agreement for the electricity generated from a particular source. It compensates the generator at a level equal to the difference between the market price and the “strike price”. If the market price is lower than the strike price, the contractor (state or regulator) pays the difference to the generator. If the market price is higher than the strike price, the generator pays back the difference. The CfD mechanism is equivalent to the German feed-in-premium, where the

government pays back the difference between the monthly price of electricity and the strike price. The UK has new construction plans for nuclear power plants at six sites. With regard to the most advanced, Hinkley Point C (EPR), the British government has approved China CGNPC (China Guangdong Nuclear Power Holding Company) participating in the project jointly with EDF, and signed a 35-year CfD agreement. The strike price is £89.5/MWh; if the planning condition of Sizewell C is not fixed before the operation of Hinkley Point C-1, it will be £92.5/MWh.

The FIT-CfD in the U.K. was created because of earlier difficulties in creating a low-carbon electricity grid. In the Climate Change Act of 2008, the UK legislated the goal of reducing greenhouse gas (GHG) emissions by 80% compared with the 1990 level by 2050. The UK's 2010 carbon reduction plan introduced the goal of reducing GHG emissions by 60% compared with the 1990 level by 2030. In order to achieve these targets, it is necessary to install 30 GW of new low-carbon power sources such as nuclear power, renewable energy, and thermal power with CCS, and provide 97% of electricity via low-carbon power sources. As yet, however, not enough has been done to meet these goals. Meanwhile, existing thermal power plants are expected to be closed due to the strengthening of the environmental regulations of the EU, and existing nuclear power plants are also scheduled to be shut down. These closures would take offline 19 GW, or 20%, of the existing power supply. In response, and in recognition of the impossibility of attracting the necessary investment for power development under traditional market mechanisms, in 2013 the Department for Business, Energy & Industrial Strategy decided to implement an electricity market reform consisting of four measures: (a) a Contract for Difference (CfD) mechanism to support investment in low-carbon power sources, (b) a capacity mechanism for securing supply capacity, (c) a Carbon Price Floor to support the carbon price, and (d) an Emission Performance Standard to improve on the low carbonization of thermal power plants.

3.3.2.2. ZEC

New York and Illinois States recently voted for another form of direct subsidy for nuclear, in the form of ZECs. Both New York and Illinois state subsidies are based on the social cost of carbon, which is adjusted by an electricity price index (energy + capacity) in order to limit the cost to the consumers. The NY subsidy is revised every other year based on the EPA (Environmental Protection Agency) cost of carbon and a forward power market index. The formula is as follows:

$$ZEC(\$/MWh) = CarbonCost - RGGI - \max(PriceIndex - 39,0)$$

with RGGI the Regional Greenhouse Gas Initiative payments (\$10.4/short ton), and the carbon cost fixed at \$42.9/short ton. The market price index is equal to the sum of the a) the day-ahead fixed price future and b) the capacity price, both averaged over two years in the zone (NY Public Service Commission, 2016). The initial ZEC calculation results in a subsidy of \$17.5/MWh. If implemented, the subsidy will secure the continued operation of three nuclear plants (3.4 GW total capacity) in upstate New York for the next 14 years.

The Illinois program has a similar structure, with more provisions on the maximum payment that the plant owners can receive. Nuclear capacity is large in Illinois, and the regulator cannot afford to subsidize

all of it. The subsidy is limited to 16% of electricity supplied to consumers, or 1.65% equivalent retail price increase on the bills of the consumers – whichever is larger¹. The subsidy is updated every year based on market price indexes. The formula is the following:

$$ZEC(\$/MWh) = CarbonCost - \max(PriceIndex - BaselinePrice, 0)$$

The carbon cost is originally taken at \$16.5/ MWh and the baseline price at \$31.4/MWh for the first calculation in 2017. The carbon cost is corrected for inflation in subsequent years. The price index is similar to the NY price index: it is a sum of a) the forward wholesale price at the Northern Illinois hub and b) the capacity price in Illinois, which is a 50/50 price blend of MISO zone 4 and PJM ComEd region (Illinois General Assembly, 2016). At current future prices, the subsidy amounts to ~\$14.7/MWh for the first year for Quad Cities and Clinton (2.9 GW total capacity).

From a design perspective, ZECs or other direct subsidies have the advantage of being closely controlled by the regulator or policy maker. The final dollar amount is set by the formulas above. Therefore, it can be tailored to the exact “competitiveness gap” that the technologies deserve and include provisions to prevent deviations. For instance the NY and Illinois subsidies target the specific plants at risk of shutdown and leave the profitable ones unsubsidized. To further guarantee the legitimacy of the subsidy, Illinois demands the plant owner to (privately) disclose its cost of generation.

History shows that in general it is difficult to determine the cost-effective level of direct subsidy that the generators deserve. Direct support programs have commonly been more costly than anticipated, and past experience shows that designers of FITs have often revised their tariff several times for the same country over a short period of time (for example in Spain). Frequent regulatory changes can send confusing signals to investors, whereas long-term vision and regulatory stability are essential for clean technologies to develop. To support large-scale investments such as new nuclear, the subsidies should be guaranteed for tens of years (35 years in the U.K.) and cannot be left at the mercy of changeable political agendas.

Direct subsidies produce results but on the other hand they can have adverse effects. They distort the functioning of electricity markets, in particular the price signal for capacity entry and exit. They alter the “natural” competition, and the bids of the generators, which are in some instance willing to bid negative prices to ensure their dispatch and receive policy payment. Negative prices have for instance appeared in several wholesale markets at times when energy demand is low and renewable generation large. The collapse of energy prices during some hours of the day negatively impacts the revenue of the technologies that don’t benefit from the same treatment. The investment and retirement decision are modified because the price signal does not reflect the payments the market agents receive. Lastly, they create a source of uncertainty in competitive markets, since the legislator has the discretionary power to support a given set of resources with short notice. This phenomena can deter future investments because investors require long-term, transparent price signals to make decisions.

In some instances (such as the “Hughes vs. Talen Energy Marketing” case), the regulator (FERC in this case) rejected the instrument because it interfered too much with markets. When designing the

¹ These two are effectively equivalent to a maximum subsidy of about \$206 million/year for Clinton and Quad Cities.

mechanism for nuclear, it is therefore essential to stress the value of the zero-carbon attribute as well as avoiding the direct interference with day-ahead and real-time wholesale markets. The New York Clean Energy Standard was designed according to this principle.

In the U.S. nuclear case, the best merits of ZECs are their effectiveness, easiness and rapidity of implementation. If approved by the Federal Energy Regulatory Commission (FERC), the NY and Illinois subsidies will have taken less than a year to be designed, voted and implemented. More states could follow and adopt a similar ZEC to preserve their nuclear capacity.

3.3.2.3. Clean Portfolio Standard

A portfolio standard is a system where electricity providers are mandated to buy a certain target of “clean” electricity, i.e. generated from clean energy sources. Certificates are granted to clean energy generators for the electricity they produce. They are then traded on an exchange platform, which provides extra revenue to the clean generators. In the U.S., portfolio standards usually comprise renewables but not nuclear nor large hydro. A more consistent approach would be to include *all* low-carbon generators in these portfolios. The nuclear fleet, with its large electricity output, would benefit considerably from this measure.

The advantage of a portfolio standard as opposed to a direct subsidy (FIT, ZEC, CfD, etc.) is that the price is set by the market instead of being dictated by the regulator or policy maker. Only the target will need to be decided in advance. Renewable portfolio standards already exist in many states of the U.S., and adding other technologies would be a minimal modification to the rules – albeit it would change the price equilibrium of the certificates. The regulator would have to adjust the mandates to prevent too much disruption.

As a disadvantage, the regulator does not directly control the level of investment in clean technologies. The price is given by the market and can be too low if excess clean generation is present. If certificates are inexpensive, new investment in low-carbon technologies will stall.

If there is a single portfolio standard, all clean generation technologies are remunerated at the same price (\$/MWh). Renewables would compete with nuclear on an equal field. Alternatively, the regulator can create several portfolio standards to differentiate different technologies. For instance in Massachusetts, solar PV has its own standard and does not directly compete with wind. The certificates from solar PV do not trade at the same price as the certificates from wind.

Subsidies to a particular generation sources tend to distort electricity market and possibly create a significant burden on the tax payers. As an example, in New England ISO, over 70 percent of the estimated net revenues for both wind and solar units in the 2015/16 period were from federal and state programs, such as Renewable Energy Credits (RECs) and the Investment or Production Tax Credits (ITC or PTC), rather than payment from consumers. [2015 Assessment of the ISO New England Electricity Markets, Potomac Economics, June 2016]. This indicates a transfer of money from public in general to a certain particular producers not as a payment to the received benefit. “Energiewende” in Germany with the goal of green renewables energy is reported to cost Germany between €100 billion and €400 billion [MIT Technology Review, May, 2016] As a consequence, it is reported that German consumers’ power prices

had increased 50% from 2006 to 2016. [Clean Energy Wire Factsheet, 16Feb2017]

The Japanese situation is particularly complex. Restart of idle nuclear power plants in Japan is forcing utilities to spend additional 30B\$/year between 2011-15 time period. This amount is expected to decrease as nuclear plants restart. However, the cost of the FIT to intermittent renewables is expected to offset this potential to reduce tariff to electricity consumers in Japan. There are other subsidies such as intermittent renewables electricity producers are not paying system cost that are necessitated by their increase share such as cost for stabilizing grid (voltage and frequency) including backup power and storage. As a consequence, policy makers are beginning either to abolish or revise FIT in many countries.

Japan's energy supply is highly dependent on both fossil fuels and imports, and Japan's energy self-sufficiency rate is very low compared to other developed countries. For this reason, the economy is vulnerable to fluctuations in the import price of energy, and it is difficult to respond to restrictions on energy imports from abroad caused by international circumstances. This is a major challenge for the supply structure. To address these issues, Act on Sophisticated Methods of Energy Supply Structures was enacted in 2009. Under this act, in order to expand the introduction of non-fossil fuel energy sources, the government sets a target to be achieved by companies and provides administrative guidance to the companies that fall short of their goals without sufficient reason. Based on the law, the government sets the target for the entire electric power business, which says the ratio of non-fossil fuel power sources should be 44% or more in 2030.

Although the target ratio for non-fossil fuel power sources for electric power companies has been set, there is no market for trading non-fossil fuel credits in Japan. For this reason, one of the practical challenges for electric power companies is their insufficient means of achieving the goal for non-fossil fuel power sources. Based on these circumstances, the creation of a new market for such credits is currently under consideration. According to the plan currently under consideration, power producers who generate electricity with non-fossil fuel power sources could obtain credit certificates from a public agency based on the amount of power generated and sell the credits in a market. When the system is implemented, non-fossil fuel power sources, including nuclear power, could gain revenue from these sales as well as the sale of the electricity itself. Non-fossil fuel power sources' competitiveness would thus also improve.

3.3.3. Clean Capacity Mechanism

Capacity mechanisms are designed to ensure adequate capacity is installed on the grid to meet the peak load demand and ensure security of supply. They provide a substantial source of revenue to generators, especially those who run for a limited number of hours per year (the "peakers"). Capacity mechanisms solve the so-called "missing money" problem that occurs when energy prices are capped and they ensure the generators are properly remunerated for the reliability they offer [Joskow, 2006]. Capacity mechanisms are therefore unnecessary when energy prices are not capped (such as in Texas, Australia). They are present in most deregulated markets of the United States (PJM (Pennsylvania, New Jersey, Maryland), New England, New York, MISO, California) and in Europe. They enable the regulator to better control security of supply by running capacity auctions several years before delivery. Early auctions also lower the risk for investors because stakeholders know what capacity price and generation mix to expect

before investing in new assets.

Capacity mechanisms can take several forms: capacity payments, capacity markets, or reliability options. They are a relatively recent addition to energy markets; their design is still on-going and reforms take place regularly. A recent change occurred in the PJM and New England capacity markets, following the 2014 polar vortex. The regulator now imposes heavy penalties to the generators that clear the capacity market but are not available when needed (i.e. during scarcity periods). Bids and prices have consequently increased. The reform helps the most reliable generators such as nuclear and hydro² be more profitable and competitive in the capacity market.

The advantage of capacity mechanisms is that they are already in place in many regions. They are a market-based approach to value reliability: the capacity needed is forecasted by the regulator and the price is given by market. It also means that the capacity price may be zero if there is over-capacity in the grid. From a design perspective, the rules of the capacity auction (time-to-delivery) are crucial for determining which new technologies can bid. If the costs of new generation change, the technology being built may be different than the one the policy-maker expected in the first place.

A more oriented and innovative approach to value reliable, low-carbon generation capacity could be to add an environmental dimension to capacity mechanisms. It would give an instrument for policy makers to ensure that a “cleaner” capacity and energy mix is achieved. The concept would be to give a premium to zero-carbon technologies and/or a penalty to carbon-emissive technologies. The environmental dimension could be directly included in the market clearing algorithm (case of a penalty), or occur after market clearing (case of a premium/ credit). The capacity auction could alternatively be set in a separate capacity market dedicated to low-carbon resource. The tender for low-carbon capacity would be run 5 to 10 years before the date of capacity delivery, such as large infrastructure projects such as nuclear and hydro –with or without new transmission lines— could compete. The demand-side of the capacity market would be composed of aggregators, large consumers and retailers. The auction would be run by the regulator or grid operator. The “clean” capacity mechanism would allow the regulator to better control the capacity mix. As a downside, load-follow and peak generators (coal, gas-fired and oil-fired) could accelerate their retirement if their capacity payments drop too quickly. It may have detrimental consequences on grid reliability and the cost of energy (currently, there is no cheap zero-emission substitute to “dirty generators” for peak generation). Therefore, the transition from classical to clean capacity mechanism should be progressive to prevent the disruption of the supply capacity.

The European Commission recently proposed to include the environmental dimension to capacity market by excluding generators emitting more than 550g CO₂/ kWh [European Commission, 2016]. This could be a first step to cleaner capacity mechanisms in Europe. In the UK, capacity auctions are held four years before delivery. Prior to holding a capacity auction, National Grid conducts a simulation to project the probability of blackouts based on multiple scenarios and examine the level of supply capacity to suppress blackouts at a certain rate. Based on the result, the authority sets the procurement target of supply capacity and the demand curve, and the actual auction is held. The 1st capacity market auction was held in December 2014, the 2nd in 2015, and the 3rd in 2016. Successful bids were made for all nuclear and hydro capacity. (The winning bid prices were £19.40/kW/year in 2014, £18.00/kW/year in 2015, and

² Provided there is no drought.

£22.50/kW/year in 2016.)

In France electricity prices are relatively low and electric heaters are widely used. The maximum electricity demand is increasing and the air temperature elasticity of electricity demand has been rising in recent years. Due to the nature of these demands, there is a need for a capacity mechanism that secures reliable supply capability. The Nouvelle Organisation du Marche de l'Electricite (NOME) Act of December 2010 made the capacity market a reality. The system imposes on retailers an obligation to secure supply capacity. RTE, an electricity transmission system operator, certifies supply capacity. Capacity certification by RTE seems to be carried out based on past performance of each power plant, and nuclear power and hydro power that can generate electricity stably are able to acquire a high authentication rate.

3.3.4. French ARENH (Regulated Access to Incumbent Nuclear Electricity) System

ARENH in France obliges EDF (Electricite de France) to conduct nuclear power supply wholesaling. In a capacity mechanism, power plants with stable power generation performance such as nuclear power and large-scale hydro power are highly valued as supply capacity. Such a mechanism is thus expected to encourage expanded use of these power sources. On the other hand, when ARENH is used speculatively, there is a concern that nuclear power revenue will be hindered. Therefore, it can be said that the French mechanism has both positive and negative effects on the use of non-fossil fuel power.

In France, total liberalization of electricity was introduced in July 2007, but the government continued to maintain a regulated tariff for political reasons. Household customers didn't move to the liberalized tariff because the level of the regulated tariff was cheaper, so the European Commission requested France to withdraw the regulated tariff. In response, the French government abolished the regulated tariff for large-scale industries in 2010, and as a measure to promote new entrants introduced ARENH, a system that obliges EDF to sell a part of the nuclear plant-generated electricity to new entrants. Under ARENH, EDF is obliged to wholesale a part of its nuclear power-generated electricity to new entrants at a price based on the power generation cost. The upper limit of the sale amount is 100 TWh, which is equivalent to 25% of the electric power generated by EDF annually, and the selling price is set at EUR42/MWh.

With the introduction of ARENH, the sales of new entrants gently increased, but in 2015 the wholesale electricity price fell below the ARENH price of EUR42/MWh. Demand was sluggish, and the electricity supplied by ARENH in 2016 fell to 0 kWh. However, the wholesale electricity price rose sharply in 2016 (from EUR25.6/MWh in March to EUR43.25/MWh in October) due to a nuclear reactor shutdown based on concerns about the plant's main equipment materials. New entrants then began to use ARENH again. In December 2016, the Commission de régulation de l'électricité (CRE) announced that applications to ARENH during the first half of 2017 amounted to 40.75 billion kWh. CRE also announced that combined with the applications for the second half of 2017, 82.2 billion kWh has already been applied for, close to the system's annual upper limit of 100 billion kWh.

Based on this situation where ARENH is used intermittently in line with the market price, EDF urged partial suspension of ARENH, saying that "ARENH may be used speculatively in light of the situation of some nuclear reactor shutdowns and the accompanying rising prices of wholesale electricity." As for actual countermeasures, however, system revision has been limited to items like making the conditions regarding cancelation from the retailer side stricter.

3.3.5. Other conceivable mechanisms

Other institutional mechanisms are conceivable to address compatibility issue of nuclear and renewables in low carbon grid such as base-load market and storage capacity market. As discussed in 3.3.3, intermittent renewables electricity producers are not paying system cost that are necessitated by their increase share. Likewise base-load electricity producers (nuclear and coal) are not paid for the value they provide to the grid. Given the value of stable supply of base load electricity in increased share of supply contingent intermittent electricity and considering its importance, Japanese experts are considering creation of base-load market as shown in Fig. 3.2. This may enable new nuclear build in a deregulated market and also contribute to energy supply security by securing a certain amount of domestic or quasi-domestic energy sources.

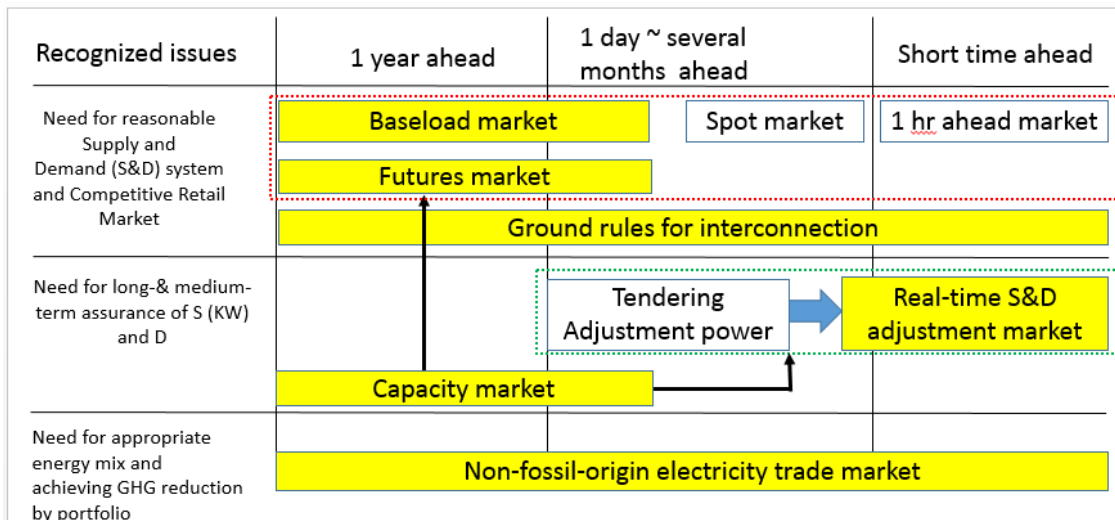

Fig 3.2 Creation of base load market

[http://www.meti.go.jp/committee/sougouenergy/denryoku_gas/denryoku_gas_kihon/pdf/002_05_02.pdf]

Other ideas may include creation of subsidies to encourage energy storage capacity on a competitive bidding basis. Intermittent renewables are supply contingent controlled by nature. Similarly, but for a different reason of economics, capital-intensive nuclear plants are expected to operate at base load all the time (in this contest, supply contingent). For these two stands in low carbon grid, energy storage plays a vital role. Subsidies to a certain particular generation sources may better be allocated to encourage energy storage capacity (kwhr or BTU) on a competitive basis, which is technology neutral and would help reinforcing infrastructure in low carbon grid. One similar program is a recent extension of SGIP (Self-Generation Incentive program) in the State of California, USA as storage-plus-solar, which is intended to encourage consumers more on solar and is different from the above technology-neutral idea. Qualifying storage technology covers a variety of technologies. [SGIP, Government of California]

References:

Baker Institute of Rice University, 2004. The role of Nuclear Power in Enhancing Japan's Energy Security".

Clean Energy Wire Factsheet, What German households pay for power, 16 Feb. 2017

European Commission, 2016. "Proposal for a Regulation of the European Parliament and of the Council on the internal market for electricity", COM(2016) 861 final/2.

Exelon, 2016. "Using Carbon Pricing in Dispatch to Meet the IMAPP Process Goal", Presentation at NE Pool meeting, August 2016.

FERC, 2017. "State Policies and Wholesale Markets Operated by ISO New England Inc., New York Independent System Operator, Inc., and PJM Interconnection, L.L.C.", Notice of Technical Conference, March.

Forsberg, C. W., et al. 2016. "Compatibility of Nuclear and Renewables with Grid Stability, Economics and Deregulation", Joint MIT-Japan White Paper.

Haratyk, G., 2017a. "Early Nuclear Retirements in Deregulated U.S. Markets: Causes, Consequences and Policy Options", CEEPR Working Paper 2017-009, Massachusetts Institute of Technology.

Haratyk, G. September, 2017b, Nuclear Asset Shutdown under Uncertainty, PhD Thesis, Department of Nuclear Science and Engineering, Massachusetts Institute of Technology.

Lazard, 2016. Levelized Cost of Energy Analysis 10.0 <https://www.lazard.com/perspective/levelized-cost-of-energy-analysis-100/>

Perez-Arriaga, I. J., 2013. "Regulation of the Power Sector", Springer Verlag, London, 2013.

Richard Martin, Germany Runs Up Against the Limits of Renewables, MIT Technology Review, May, 2016

SGIP, Government of California, <http://www.cpuc.ca.gov/sgip/>

2015 Assessment of the ISO New England Electricity Markets, Potomac Economics, June 2016

4. Models

Energy systems are highly complex. Models are used to simulate the real world to understand the implications of different technology and policy choices. Several different models were used in this study to develop an understanding of the likely evolution of the electricity grid under a wide set of circumstances. The models and the results of those models are described herein.

4.1. MIT GenX Model

To model a low-carbon electricity grid, MIT [Sepulveda, 2016a; Sepulveda, 2016b] developed a long-term generation investment model, GenX, to determine the minimum cost generation mix, subject to different carbon emissions constraints and different technological pathways. GenX is a capacity expansion model with clustered unit commitment constraints whose main characteristics are: (1) reflecting the impact of hourly operational constraints on investment decisions and on total generation cost, (2) accounting for the chronological variability of demand and renewable output, and the correlation between the two, and (3) deciding on power plant investments and operation at the individual plant level. Each technology is characterized by a particular set of operational and economic parameters. For technologies such as wind and solar, this includes the wind and solar conditions for each hour of the year. Additionally, GenX is capable of modeling new technology concepts. In its current configuration, it is a top down model that defines what an optimum system would look like if built from the ground up. The model has also been used for the MIT Future of the Utility Study and the NEA System Cost Report

GenX [Sepulveda, 2016a] was used to model the electric sector of different Independent System Operators (grids) in the U.S. for a projected demand in 2050 as a function of different technology choices and different constraints on carbon dioxide emissions. Figure 5.1 shows the average cost of electricity versus different technological choices for electricity generation and different limits on greenhouse gas emissions for ERCOT—the Texas electricity grid.

- *Average Cost of Electricity (Vertical axis)*. The vertical axis is the average cost in dollars per Megawatt hour. The model optimization goal is to minimize average electricity cost given any set of constraints while fulfilling demand.
- *Technology Choices (Horizontal axis)*. The X-axis defines allowed technical choices. The graph shows two sets of options, one with no nuclear and the other including nuclear power generation.
 - *Non-Nuclear Futures*. From right to left in this specific example the technological choices are:
 - RN&S. The generation system can include natural gas, solar, wind, pumped hydro and battery storage. The cost optimization determines which technologies are used and the relative amounts of each generation type.

- +DMS1. The generation system can include all of the above plus demand side management to reduce electricity loads.
 - +DR1. The generation system can include all of the above plus demand response; that is, price responsive curtailment of load where a penalty in dollars per kilowatt is imposed when demand is not met.
- *Nuclear Futures with Renewables*. From right to left in this specific example on the same graph the technological choices are: .
 - RN&S&LWRs. This includes all the generation options in the first bullet above (RN&S) plus light water reactors (LWRs). The LWRs can operate at part load. As with all other generating technologies, the limitations are included such as how fast the LWRs can change power levels.
 - +DNS2. The generation system directly above that includes LWRs plus demand side management to reduce electrical loads
 - +DR2. The generation system directly above that includes LWRs plus demand response.
 - +CHP. The generation system directly above plus heat storage and combined heat and power systems.
 - +NACC. The generation system directly above plus high-temperature reactors with Nuclear Air-Brayton Combined Cycles that can burn natural gas for peak power.
- *Carbon Dioxide Emission Limits (Horizontal Axis)*. The Y-axis defines the allowable carbon dioxide emission limits in grams per kWh of electricity that is generated. At 400 g/kWh, all of the electricity can be produced by natural gas if that is the lowest cost option. As this limit is reduced, the carbon dioxide emissions are limited that limits the burning of fossil fuels. Although a particular scenario will include gas turbines, as limits are tightened, the number of hours per year gas turbines are allowed to operate is reduced.

The optimum mix of each set of technologies to minimize costs is determined for different constraints on carbon dioxide emissions. Figure 4.2 shows the corresponding installed capacities of the different technologies.

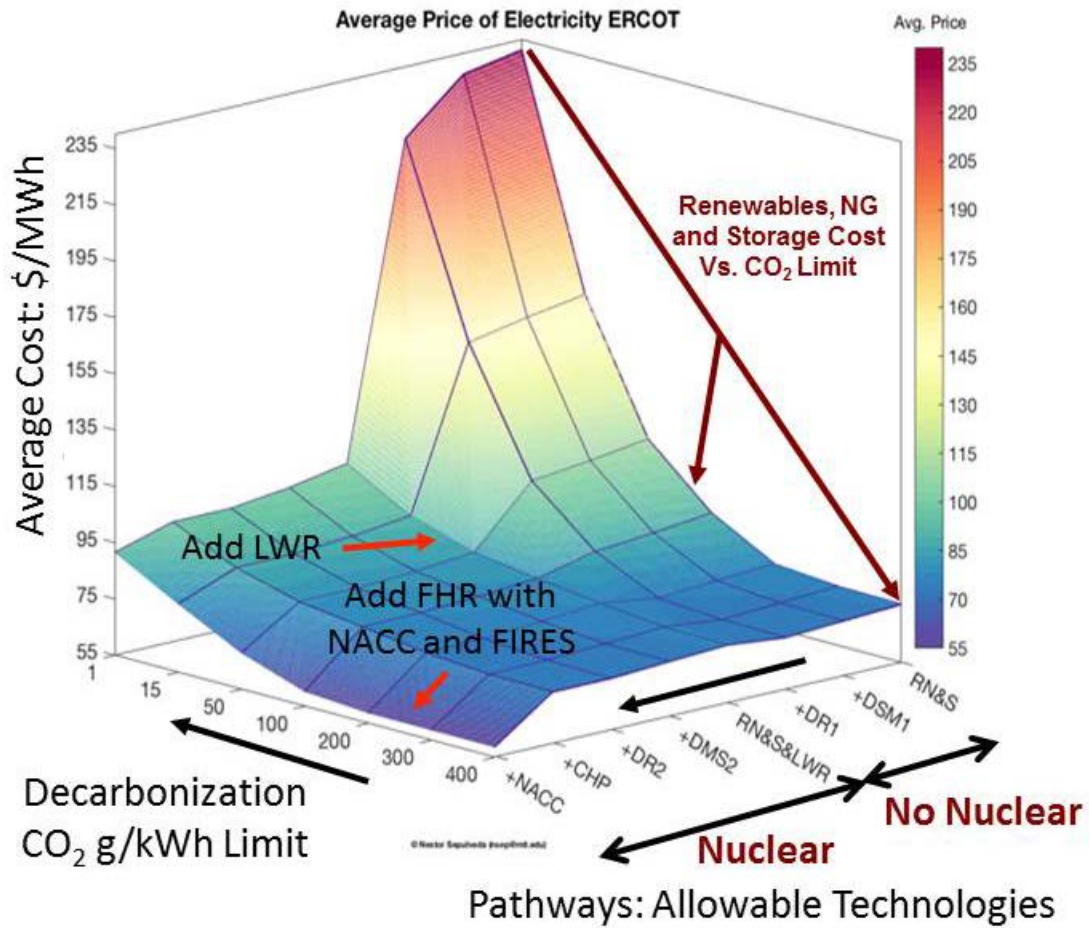

Fig. 4.1. 2050 Minimum-Cost Texas Grid vs. Allowable Generation Technologies and CO₂ Emissions in g/kWh.

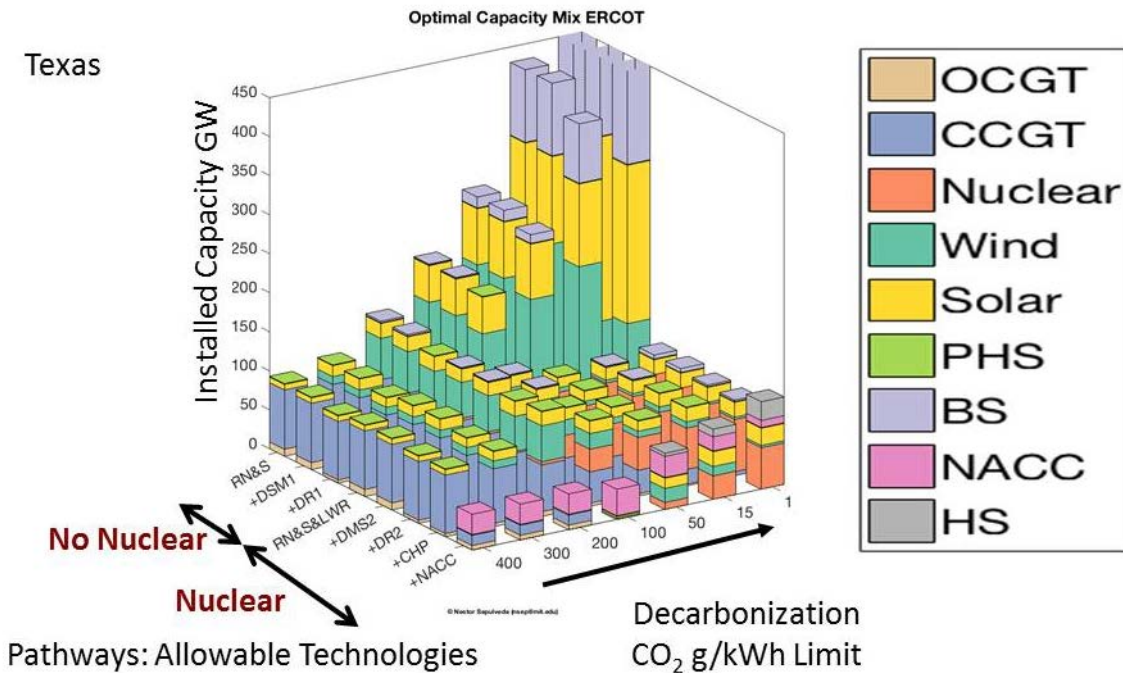

Fig. 4.2. Optimal 2050 Texas Installed Capacity vs. Added Technologies and CO₂ Limits

For the Texas case (Fig. 4.1) the low-cost system without constraints on carbon dioxide emissions is primarily based on natural gas with very limited quantities of pumped storage and solar. This reflects the effect of low prices of natural gas in optimal generation planning. New technologies with different characteristics, such as a high-temperature reactor with a Nuclear Air-Brayton Combined Cycle (NACC) can make a difference. If NACC existed today, it would replace many combined-cycle natural gas plants because it can burn natural gas more efficiently than a stand-alone natural gas plant.

As one begins to limit allowable carbon dioxide emissions and natural gas for electricity production, the optimum choice of technologies change. What technologies are chosen depends upon what technologies are allowed. If the only options to natural gas are renewables, the costs climb rapidly. This cost increase is associated with the cost to address the non-dispatchability of renewables. Technologies such as batteries and pumped storage can be added but at high costs. In contrast, if LWRs are allowed in the mixture—a dispatchable method to produce electricity, the cost increases are much less. Similar results would be obtained if there was no nuclear but natural gas with carbon capture and sequestration were allowed.

The total electricity costs and optimum mix of technologies depends upon the electricity grid. Texas has high-grade wind and solar resources—near a best-case environment for the use of renewables in the United States. The same model with the New England electricity grid shows significantly higher costs and a different set of optimum generation technologies because of the low quality of renewable resources relative to Texas. If Japan was modeled, there would be little use of natural gas because of its high costs.

Different cost assumptions will produce different results. Details on the different numbers used to produce the results presented in previously and the results for different sensitivity analysis can be found in Sepulveda [2016a]

There are some common conclusions that appear in all the cases that have been examined using different electrical grids and a wide variety of cost assumptions.

- *Need for a dispatchable electricity source.* The cost of electricity from a grid with fossil fuels and non-dispatchable electricity generating systems (wind, solar, etc.) will increase rapidly as restrictions are tightened on carbon dioxide emissions compared to an electricity grid with a mixture of dispatchable low-carbon technologies and non-dispatchable (wind and solar) electrical generating technologies because of the cost of energy storage. In the examples above, one sees a dramatic reduction in electricity costs if dispatchable nuclear (LWR) is among the technologies allowed in the generating mix when there are tight constraints on carbon dioxide emissions. Similar results would be achieved if one found another dispatchable technology with similar technical and economic characteristics—such as potentially natural gas with carbon dioxide sequestration. If one depends upon just renewable energy sources, the costs of storage drives the system design and begins to dominate electricity costs.
- *The optimum generation mix of low-carbon electricity sources changes with greenhouse gas emission constraints.* For example, in the Texas case as greenhouse gas emissions become tighter, wind is first preferred; however, given very tight limits on greenhouse gas emissions, solar overtakes wind while the optimum wind capacity decreases. This is because with very tight limits on carbon dioxide emissions, added solar reduces the quantity of storage required compared to wind given Texas wind and solar conditions. In a different system with different solar and wind resources, the results would be different but the optimum generation mix changes with carbon dioxide constraints. This places large incentives to consider what the requirements for the long-

term system are to avoid over-investing in technologies that may meet near-term goals but are the wrong set of technologies to meet long-term goals.

- *More technologies with different characteristics generally lower total societal costs of electricity.*
- *The value of any electricity generating technology declines with the scale of deployment.* As shown in Chapter 2, the value of the first solar plants is high because the electricity is produced at times of peak demand. The value of additional solar goes down as more solar capacity is added. The same is true of any other generating or storage technology.

A recent review [Jenkins, 2017] of the results of many different electricity grid models by different investigators reached similar conclusions. In particular, the cost of electricity becomes very high in low-carbon electricity grids unless there is a dispatchable electricity generating technology that can produce electricity when required—be it nuclear, fossil fuels with carbon capture and sequestration or some other technology. A replacement for the variable dispatchable characteristics of fossil fuel electricity generation is required.

Exiting nuclear plants can meet this requirement by going up and down in power; but, large savings are potentially possible if nuclear systems designed explicitly for variable power output are developed—such as discussed in Chapter 2.

4.2. University of Tokyo Optimal Power Generation Mix Model (UT, Japan: Fujii)

In order to accommodate higher RES penetration, a strategic energy policy is required for transforming power grid, and the model here is suitable to support such a policy formulation. Analysis is done on the electric power grid with large-scale RES integration in Japan by employing an optimal power generation mix (OPGM) model [Komiya and Fujii, 2017]. The model is developed with a linear programming technique where the minimization of total power system cost allows us to identify the national best power generation mix in a single year. The power grid in the model consists of 135 nodes and 166 high-voltage power transmission lines in 10-min temporal resolution through a whole year. The topology of power network explicitly considered in the model is shown in Figure 4.3.

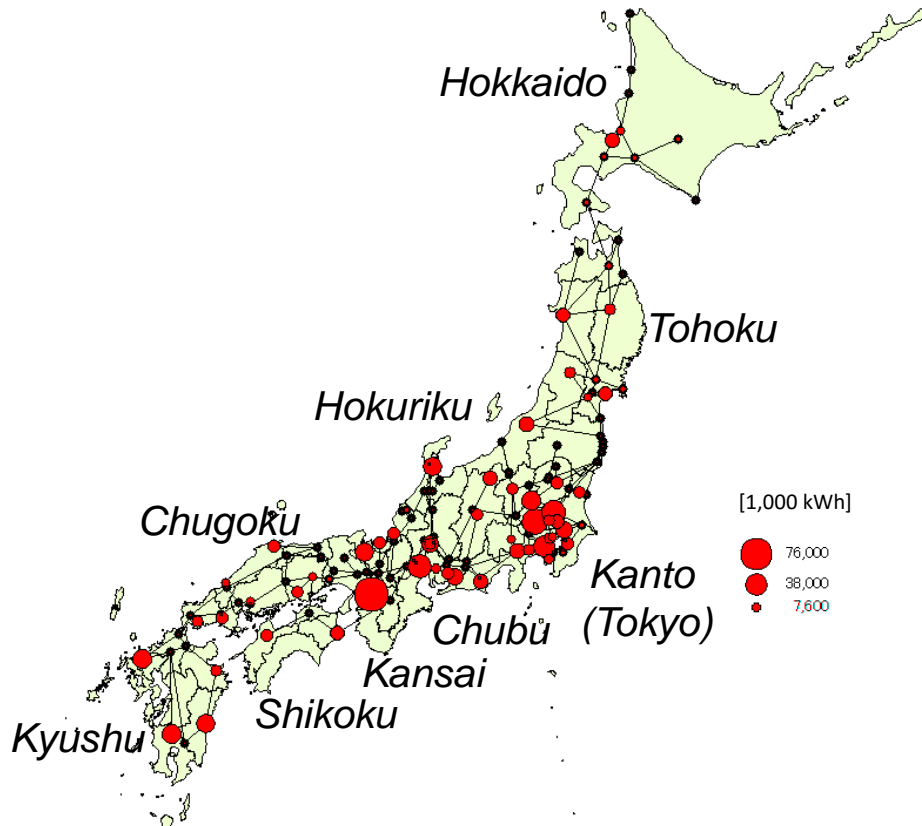

Fig. 4.3. Geographical distribution of high-voltage power transmission line and nodes in OPGM model.

First, the OPGM model is employed to analyze the installable potential of Firebrick Resistance-Heated Energy Storage (FIRES). In the FIRES, fluctuating electricity such as IRs output is assumed to be charged through resistance heating, stored in fire brick and supplied to satisfy heat requirement in industrial sectors, as shown in Figure 4.4. Heat demands in the industrial sector are assumed to be constant through a whole year.

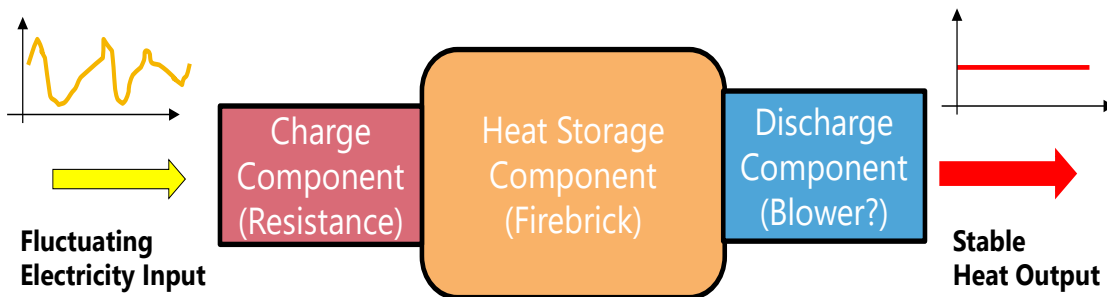

Fig. 4.4. Schematic diagram of MIT FIRES in OPGM model.

The OPGM model includes pumped-hydro, sodium-sulfur (NAS) battery and Li-ion battery, and the installed capacity of FIRES endogenously determined through the cost competitiveness against those energy storage technologies. The cost of FIRES is assumed in four scenarios (Case 0,1,2,3) concerning the unit construction cost of charge component, heat storage component and discharge component where Case 0 and Case 3 show the lowest and the highest cost assumptions respectively. Figure 4.5 shows electricity price duration curves in Hokkaido region which is calculated as the annual series of the shadow price of electricity demand. In the scenario which does not consider FIRES (No FIRES), the electricity prices drop to nearly zero in more than half of the year, because the surplus wind output causes the excessive electricity supply over the demand, which eventually drops the electricity prices. When FIRES becomes economically affordable and is installed, it uses the excessive wind output to heat firebrick and provide heat for industrial usage when electricity prices are lower, and adequately balances the electricity demand and supply. Therefore, particularly as observed in Case 0 (the lowest FIRES cost) in Fig 4.5, a sharp decline of the electricity price caused by large-scale RES penetration is largely mitigated.

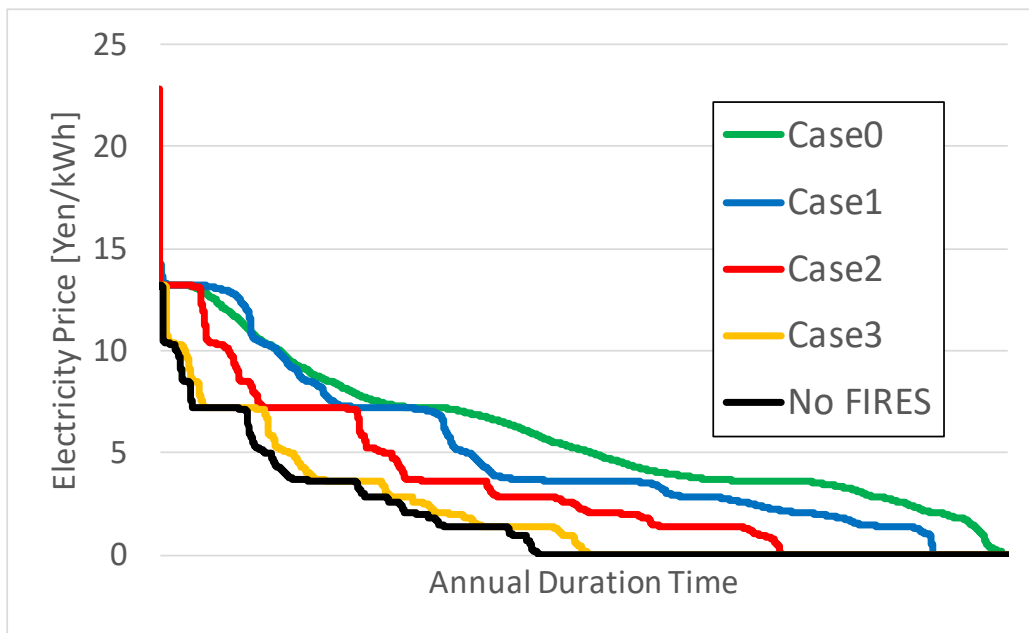

Fig. 4.5. Price duration curves in Hokkaido.

For the future, in addition, hydrogen is considered as a potential storage medium for a low-carbon power grid. Hence, the OPGM model combined with hydrogen storage system, as shown in Figure 4.6, is used to assess its installable potential. In the system, IRs output is used to produce hydrogen and the hydrogen is stored in aboveground steel tank. After that, the stored hydrogen is converted into electricity by a fuel cell or hydrogen turbine [Komiyama and Fujii, 2015].

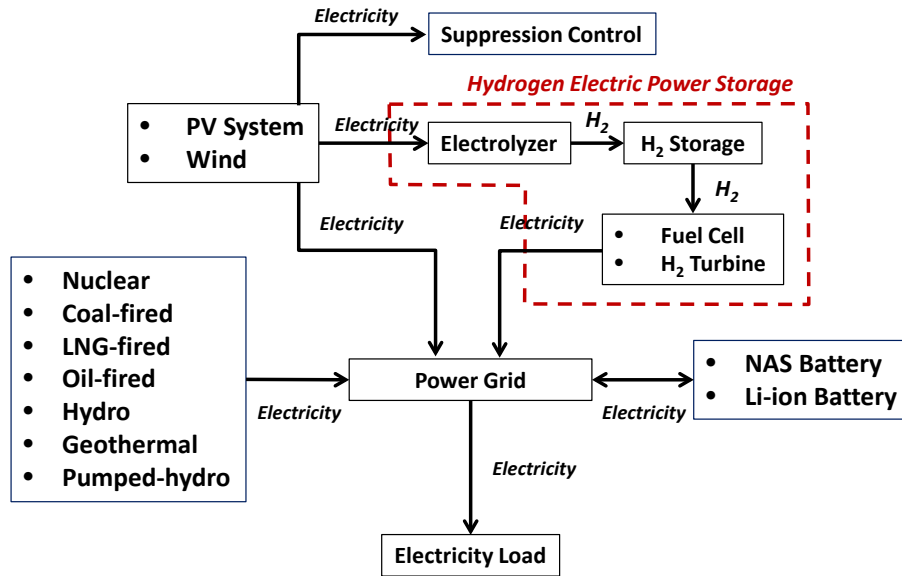

Fig. 4.6. Optimal power generation mix model combined with RES-based hydrogen storage system.

With the model, sensitivity analysis is performed to evaluate the economic competitiveness of hydrogen produced from wind or PV via electrolysis with hydrogen storage. The sensitivity study is conducted on carbon regulation policy. The costs of all elemental technologies of hydrogen storage system including electrolyzer, hydrogen storage and hydrogen-fueled generator are assumed to decline together by 80 percent from the reference prices, because there is limited use of hydrogen technologies at the other cost assumptions. Carbon emissions are regulated by 60, 70 and 80 percent reduction from the level of the reference emissions. Fig 4.7 suggests that strict carbon regulation policy accelerates the installations of wind and 10 percent of the wind output is used for hydrogen production in the 80% CO₂ reduction case, while less hydrogen is produced from PV output. The results imply the possible effective role of hydrogen storage system in the power grid integrated with large-scale renewable energy.

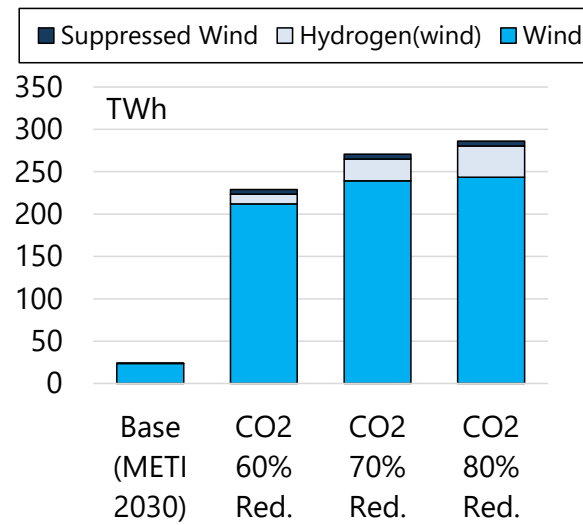

Fig. 4.7. Breakdown of wind power output for grid supply, hydrogen production and curtailment.

4.3. Other Models

A recent review [Jenkins, 2017] of electricity grid models by different investigators using different assumptions and different models have reached similar conclusions. In particular, the cost of electricity becomes very high in low-carbon electricity grids unless there is a dispatchable electricity generating technology that can produce electricity when required—be it nuclear, fossil fuels with carbon capture and sequestration or some other technology. A replacement for the variable dispatchable characteristics of fossil fuel electricity generation is required. The Jenkins review examined various estimates of wind and solar capacity required to replace fossil-dominated systems as shown in Fig. 4.8. Because of the variability of wind and solar, power systems with high shares of these resources have much greater installed capacity and energy storage (see below) than more diverse systems to overcome their non-dispatchability. This implies significantly higher energy costs. A summary of the results of other papers is below.

- Plessmann and Blechinger (2017) examined a scenario for decarbonizing the European power system that reduced greenhouse gas emissions by 98.4% relative to the 1990 emissions level that relies on expansion of wind and solar. The total installed capacity is 4.2-times larger than the peak installed capacity in the current fossil-based system.

- Elliston, MacGill and Diesendorf (2014) examined a 100% renewables system for Australia that resulted in peak generating capacity three times of the current fossil-based system.
- Brick and Thernstrom (2016) examined a similar system for the United States with total renewables installed capacity between 3.5 and 5.5 times that of a more balanced system.
- Mai, Mulcahy, et. al. (2014) examined a similar system for the U.S. with a goal of 80% renewable electricity that doubled installed capacity.

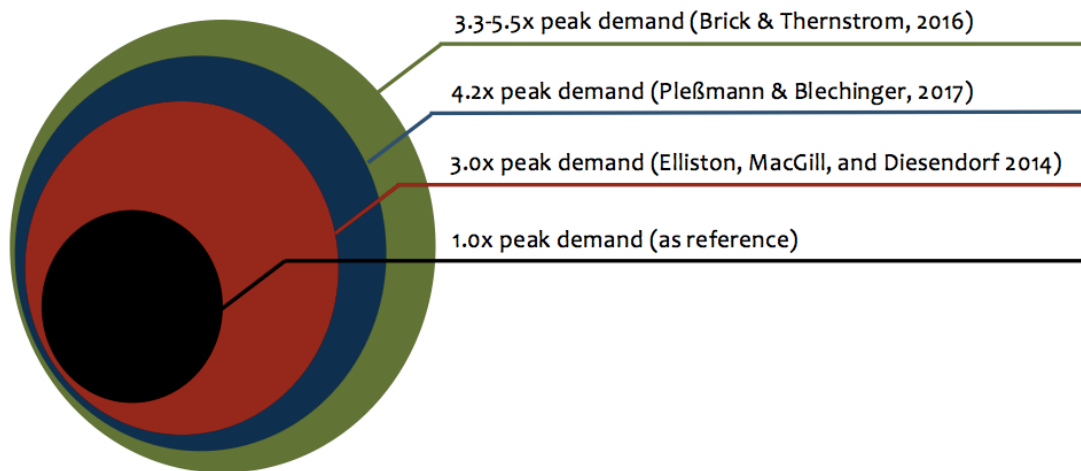

Fig. 4.8. Installed Capacity for Low-Carbon Wind and Solar Power Systems Relative to Capacity of Current Systems (Courtesy of Jenkins)

Jenkins also reviewed the energy storage requirements for proposed systems with high wind and solar output. Without reliable dispatchable energy sources, the storage requirements become very large. Figure 4.9 summarizes the results of different studies. To give some perspective of the size of these systems, the total storage capacity envisioned by Jacobson et al is equivalent to 37.8 billion Tesla Wall 2.0 home energy storage systems—320 Power Walls per U.S. household. This is driven by seasonal storage requirements.

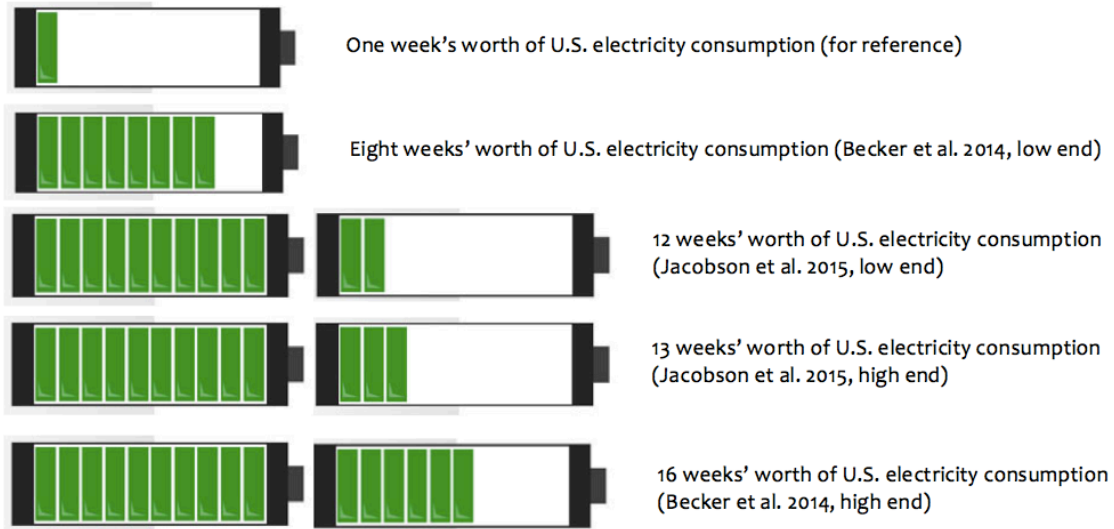

Fig. 4.9. Energy Storage Capacity Required in 100% Renewable Electric Scenarios (Courtesy of Jenkins)

4.4. Conclusions

The conclusion based on multiple studies using multiple methodologies and a wide variety of different assumptions is that energy systems without dispatchable energy sources are much more expensive with the cost rising dramatically as restrictions on greenhouse gas emissions are increased. A major challenge of a low carbon world is replacing fossil fuels as a dispatchable energy source. The existing low-carbon dispatchable energy source is nuclear energy. There are other potential options such as burning fossil fuels with carbon capture and sequestration.

References

Becker, S. ET. al., 2014. "Features of a Fully Renewable US Electricity System: Optimized Mixes of Wind and Solar PV and Transmission Extensions," *Energy*, **72**, 443-58.

Doi.10.1016/j.energy.2014.05.067.

Brick, S. and S. Thernstrom, 2016. "Renewables and Decarbonization: Studies of California, Wisconsin, and Germany", *The Electricity Journal*, **29** (3), 6-12, doi:1016/J.tej.2016.03.001.

Elliston, B., I. MacGill, and M. Diesendorf. 2014. “Comparing Least Cost Scenarios for 100% Renewable Electricity with Low Emission Fossil Fuel Scenarios in the Australian National Electricity Market”, *Renewable Energy*, **66**, 196-204, doi:10.1016/j.renene.2013.12.010.

Jacobson, M. Z., et. al., 2015. “Low-Cost Solution to the Grid Reliability Problems with 100% Penetration of Intermittent Wind, Water, and Solar for All purposes”, *Proceedings of the National Academy of Sciences* **112** (49): 15060-65, doi:10.1073/pnas.1510028112.

Jenkins, J. D. and S. Thernstrom, 2017, *Deep Decarbonization of the Electric Power Sector Insights from Recent Literature*, <http://innovationreform.org/wp-content/uploads/2017/03/EIRP-Deep-Decarb-Lit-Review-Jenkins-Thernstrom-March-2017.pdf> , March.

Plessmann, G. and P. Blechinger. 2017. “How to Meet EU GHG Emission Reduction Targets? A Model Based Decarbonization Pathway for Europe’s Electricity Supply System until 2050”, *Energy Strategy Reviews*, **15**, 19-32. doi:10.1016/j.est.2016.11.003.

Mai, T. et. al., 2014. “Envisioning a Renewable Electricity Future for the United States”, *Energy*, **65**. Elsevier Ltd: 374-86, doi:10.1016/j.energy.2013.213.11.029

Sepulveda, N., 2016a, *Decarbonization of Power Systems: Analyzing Different Technological Pathways*. MS Thesis, Massachusetts Institute of Technology, Cambridge, MA, 2016

Sepulveda, N. and Jenkins, J., 2016b, GenX: Enhanced Decision Support for a Changing Electricity Landscape: the GenX Configurable Electricity Resource Capacity Expansion, MIT Research Initiative, Massachusetts Institute of Technology.

5. Conclusions and Recommendations

Background

To maintain standards of living in the developed world and to eliminate poverty worldwide requires massive quantities of energy and massive growth in energy resources. Energy is about 8% of the gross national product of the world. It is essential to avoid large increases in energy costs that would significantly decrease human welfare.

The energy sector and especially the electricity sector are undergoing three paradigm shifts. The first is the move to deregulated electricity markets in which electricity producers compete based on price without much attention to social goals. The second is the start of a transition to a lower-carbon world driven by concerns about climate change and the growth of non-dispatchable electricity generation (wind and solar) primarily but not entirely driven by subsidies. The third is a more decentralized electricity grid enabled by new more decentralized generating technologies and the smart grid that enables shifting electricity demand by a few hours.

The near-term energy pathways of the U.S. and Japan have some similarities but also significant differences. In the United States the development of fracking has driven down the price of natural gas that, in turn, has resulted in large decreases in electricity prices and reduced carbon emissions as natural gas replaces coal. The decrease in electricity prices has resulted in retirement of some nuclear plants and is expected to cause the early retirement of additional nuclear power plants. In Japan the Fukushima accident has resulted in shutdown of multiple nuclear plants. Both countries have placed a large emphasis on deployment of renewables supported by various subsidy mechanism. The costs of such support in the U.S. are not visible because of the much larger effects of decreasing natural gas prices. In Japan customer tariffs have increased by ~19% for residential customers and ~29% for industrial customers.

Challenges

For the last 300,000 years there have been no changes in human energy policies—throw a little more carbon (wood, coal, oil, natural gas) on the fire. The cost of the cooking stove or the gas turbine was small relative to the cost of finding and collecting the fuel for the fire—wood, coal, oil or natural gas. As a consequence the cost of meeting variable energy needs by operating the cooking fire or gas turbine at part load was small. Economically the power conversion system had low capital costs and high operating costs.

In a low-carbon world the energy sources are nuclear, wind and solar. These technologies have high capital costs and low operating (fuel) costs. If these technologies are operated at half capacity, the cost of energy production approximately doubles. Nuclear is dispatchable and can meet variable energy demands

but with an economic penalty. Wind and solar are not dispatchable. The question therefor is how do we create an economic energy system with minimum burden to the society by a combination of low-carbon dispatchable and non-dispatchable energy sources, replacing the traditional role of fossil fuels, to fulfill the requirements for a safe, secure, affordable and environmentally acceptable energy source?

There are other challenges. Burning fossil fuels provides heat at small and large scales. Nuclear energy generates heat at a large scale but not a small scale. Large-scale use of wind or solar results in electricity price collapse at times of high wind or solar output that limit economic deployment of these energy systems. Methods are needed to productively use this excess electricity generated in low-carbon grids to limit energy costs to society. Price collapse caused by deep penetration of intermittent renewables are deteriorating electricity markets for base-load energy sources such as nuclear and economically favor the use of fossil fuels for variable electricity production to provide energy at times of low solar and wind output. Intermittent renewables with existing technologies lock in the use of fossil fuels with their cost structure of low capital costs and higher operating costs. There is a need for technology and institutional innovation.

Last, a low-carbon world is a world with much more diverse energy systems. Fossil fuels are cheap to transport; thus, the energy systems worldwide are similar. In a low-carbon world the costs of wind and solar vary by an order of magnitude depending upon location. This implies that there will be much larger differences in energy systems across Japan or the United States than there currently is.

Technology Options for Nuclear Energy Replacing Fossil Fuels

Low-cost energy storage is required in a low-carbon world to match energy production with demand to maximize use of high-capital-cost nuclear, wind and solar systems. Nuclear reactors produce heat that is then converted to electricity. Heat storage is much less expensive than electricity storage (pumped hydro, batteries, etc.); thus, there are large incentives to develop heat storage technologies for nuclear reactors to enable base-load reactors with variable heat and electricity output—replacing fossil fuels for variable energy production. Low-cost storage improves nuclear and non-dispatchable renewable economics by addressing the storage challenge of renewables.

For light water reactors with steam cycles, six classes of heat storage technologies exist (steam accumulators, sensible heat storage, cryogenic air storage, hot rock storage, geothermal heat storage). Some of these technologies could be deployed in a few years but others require significant research. There are a different set of heat storage technologies for higher-temperature reactors that can couple to a gas turbine. This includes longer term options with the potential of enabling a reactor power station to buy or sell electricity while the reactor operates at base load.

Heat storage systems such as Firebrick Resistance Heated Energy Storage (FIRES) may enable

productive use of excess electricity by the industrial sector at times of high wind or solar output. These systems convert low-price electricity into high-temperature heat that substitutes for fossil fuels in industrial furnaces and kilns.

In addition to electricity, societies need other energy sources for industry and transport. This includes production of hydrogen, ammonia, liquid hydrocarbons, and industrial heat. Hydrogen receives special attention because it is required for production of many chemicals, may replace fossil fuels for production of steel and other metals, is an input to ammonia and liquid hydrocarbon production, and may be used for peak electricity production. Hybrid energy systems that couple nuclear with renewables may provide the most economic strategy to produce these products where nuclear reactors provide heat with variable electricity from wind and solar.

The transition to a low-carbon world adds a fourth criteria for R&D of advanced reactors: (1) economics of base-load electricity, (2) sustainability involving fuel cycles, (3) safety, and (4) enabling storage and hybrid production of electricity and energy carrier. This fourth requirement enables nuclear to replace fossil fuels as a dispatchable energy source and enables efficient large-scale coupling of non-dispatchable renewables to the energy system. The recommendation reflects the fundamental differences between nuclear, wind and solar. Nuclear is a heat-producing dispatchable energy generating technology while wind and solar (PV) are non-dispatchable electricity generating technologies.

The central recommendation is the need to develop multiple technologies to provide dispatchable energy.

Market Mechanism Options

The challenge for a low-carbon energy system is economics. Markets provide the most efficient mechanism to minimize economic costs to society but do not consider societal environmental or security constraints. Market rules can be used to enable markets to include these goals. There are several options to fully utilize markets to minimize societal costs while meeting low-carbon goals

- A carbon tax on fossil fuels is the most efficient mechanism to reduce carbon dioxide emissions. Other types of carbon constraints on utilities may raise electricity rates that results in other industries increasing direct use of fossil fuels to minimize electricity consumption. Such transfers of carbon dioxide emissions between industries is avoided with a carbon tax.
- If specific rules for the utility industry are implemented, subsidies need to be linked with carbon displacement and market price of electricity. The advantage of a portfolio standard as opposed to a direct subsidy (FIT (Feed-in-Tariff), ZEC (Zero-Emission Credits), CfD (Contract-for-Differences), etc.) is that the price is set by the market instead of being dictated by the regulator.

If there is a single portfolio standard, all clean generation technologies are remunerated at the same price (\$/MWh). Renewables, nuclear, efficiency and other technologies would compete on an equal field.

- A more market oriented and innovative approach to value reliable, low-carbon generation capacity could be to add an environmental dimension to capacity mechanisms. It would give an instrument for policy makers to ensure that a “cleaner” capacity and energy mix is achieved

The history of narrow focus subsidies in the Europe, the United States, and Japan has not been good. The classic example has been FITs for specific renewable technologies where the costs of such subsidies have proven much larger than anyone expected. This outcome is to be expected because nobody is good at predicting advances in technologies—technology surprises such as natural gas fracking continue to appear. If subsidies are used to encourage technologies, the subsidies should be to support all technologies that meet a specific functional goal such as storage.

Use of analytical model and the results of analysis

The real world energy system is extremely complex with many feedback loops. To develop an understanding of this system, two models were used.

The MIT GenX, model was used to determine the minimum cost generation mix, subject to different carbon emissions constraints and different technological pathways. There were two major conclusions. First, the cost of electricity from a grid with fossil fuels and non-dispatchable electricity generating systems (wind, solar, etc.) will increase rapidly as restrictions are tightened on carbon dioxide emissions compared to an electricity grid with a mixture of dispatchable low-carbon technologies and non-dispatchable (wind and solar) electrical generating technologies. Second, the optimum generation mix of low-carbon electricity sources changes with greenhouse gas emission constraints. One must think long-term to avoid making investments in generating technology that must then be abandoned a decade later.

The University of Tokyo OPGM (Optimal Power Generation Mix) model was used to determine power system cost in the grid with large-scale integration of intermittent energy resources (IRs) in Japan. It was concluded that when FIRES becomes economically affordable and is deployed in Hokkaido area on a large scale (high wind zone in Japan), by storing excessive electricity from wind to heat firebrick and later by providing heat for industrial usage when electricity prices are lower, adequately balances the electricity demand and supply are possible and that sharp decline of the electricity price caused by large-scale IRs penetration is largely mitigated. The price collapse challenge can be addressed separately from the requirement for assuring electricity at times of low wind or solar input.

Recommendations

1. Technological and institutional innovation is required for both nuclear power and intermittent renewables to enable a low-carbon affordable energy system.
2. A fourth criteria for R&D of advanced nuclear reactors is necessary, namely the ability to produce dispatchable electricity and heat to replace the role provided today by fossil fuels. That capability assures compatibility with intermittent renewables in electricity and heat markets, enabling hybrid production of electricity and other energy carriers
3. Multiple technologies need to be developed to provide dispatchable energy. Humans are only beginning the transition to a low-carbon system. This report is a snapshot in time of future nuclear technology options but we are very early in this transition.
4. Excessive subsidies tend to distort electricity market and, when remunerated, all clean generation technologies should be remunerated at the same price.
5. A more oriented and innovative approach to value reliable, low-carbon generation capacity could be to add an environmental dimension to capacity mechanisms. It would give an instrument for policy makers to ensure that a “cleaner” capacity and energy mix is achieved
6. Given the important role of energy storage, subsidies could be applied, on a competitive basis, to all storage capacity as well on an equal basis.
7. Further model development and analysis is recommended to help guide research and policies to power systems with the minimum burden to the society by a combination of low-carbon dispatchable and non-dispatchable energy sources.

Appendix A: Impact of Large Scale Solar: The California Duck Curve

California has implemented laws to force the large-scale use of renewables for electricity generation in two forms: various financial incentives and a renewable portfolio standard that requires the electricity grid operator to buy renewables. At the same time it has a deregulated wholesale electricity market. The wholesale electricity market reflects the price (value) of electricity. The incentives for the renewables are paid by the taxpayer and the electricity ratepayer whose electricity bill includes the wholesale price of electricity plus transmission costs plus subsidies to renewable electricity producers.

In the last several years the impacts of these policies have begun to appear in the form of two “duck curves”. The first duck curve (Fig. A.1) shows electricity demand for dispatchable electricity on a typical spring day. Because solar input is during the day, it depresses electricity demand from other power generators at these times and demands that the output of other electricity generators vary rapidly as the sun goes down. This is particularly severe in California because peak demand is near sunset.

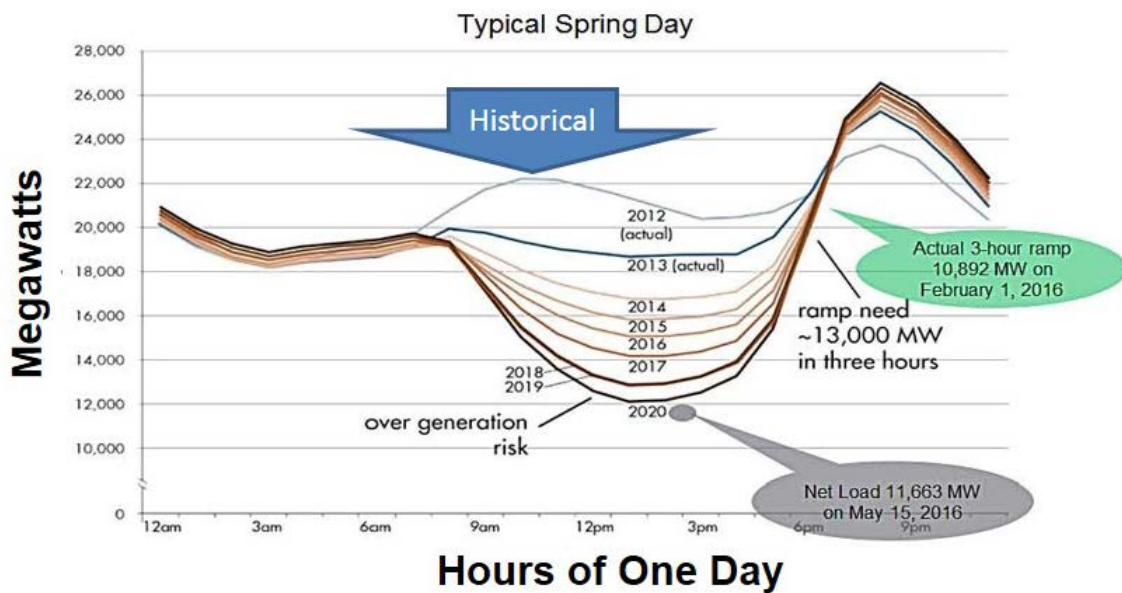

Fig. A.1. California “Duck Curve” of Dispatchable Demand for Electricity Versus Time Over a Spring Day as More Solar is Added to the California Electrical Grid [CALIFORNIA ISO, 2016]

The second “duck curve” is the corresponding wholesale price of electricity as shown in Figure A.2 for the second Sunday in April in 2012 and 2017. The difference in these two curves is because of the large-scale addition of solar that drove the price of electricity below zero. That was possible because the California electricity grid was required to pay solar producers subsidies so the subsidies plus market value of electricity would provide sufficient revenue to encourage expansion of solar. Solar producers on days of high solar output and lower demand were willing to pay the electricity grid to take their electricity to enable them to collect much larger subsidy payments for that electricity.

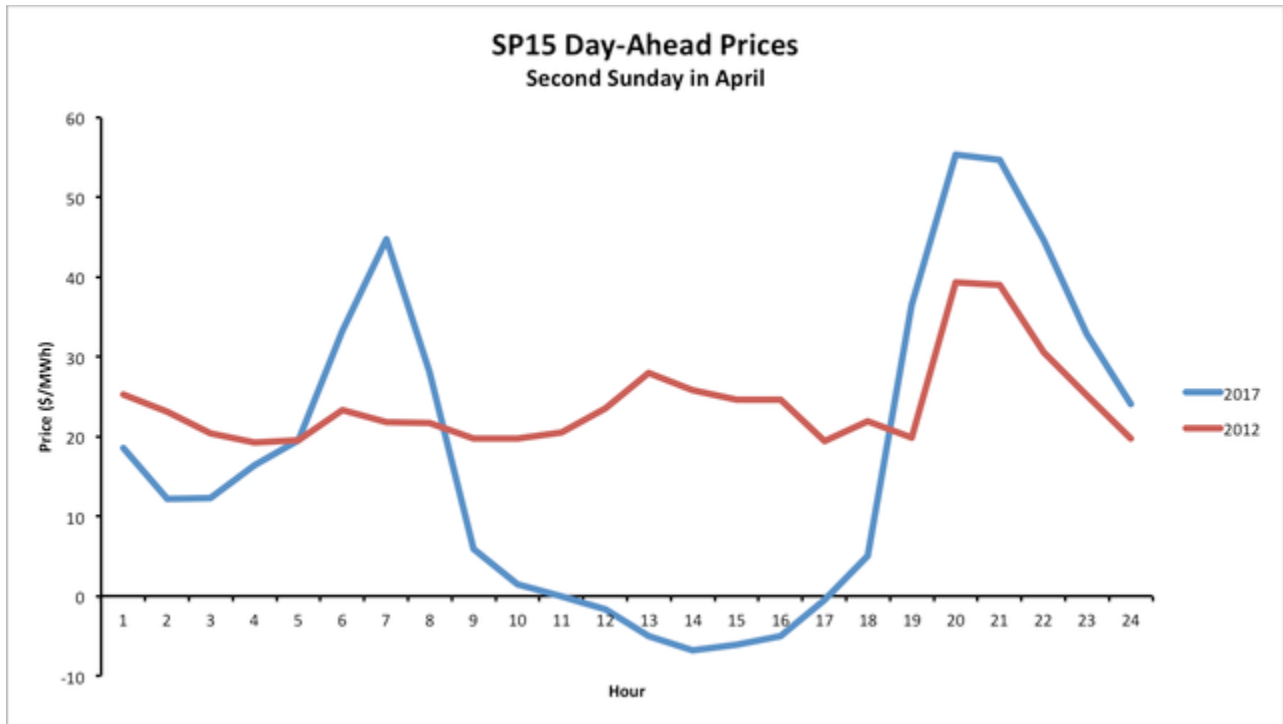

Fig. A.2. Wholesale electricity prices over 24 hours During the Second Sunday of April in 2012 and 2017 (Source: California ISO [OASIS](#))

The corresponding actual electricity production from different sources is shown in Fig. A.3 that includes the contribution of wind and solar electricity production.

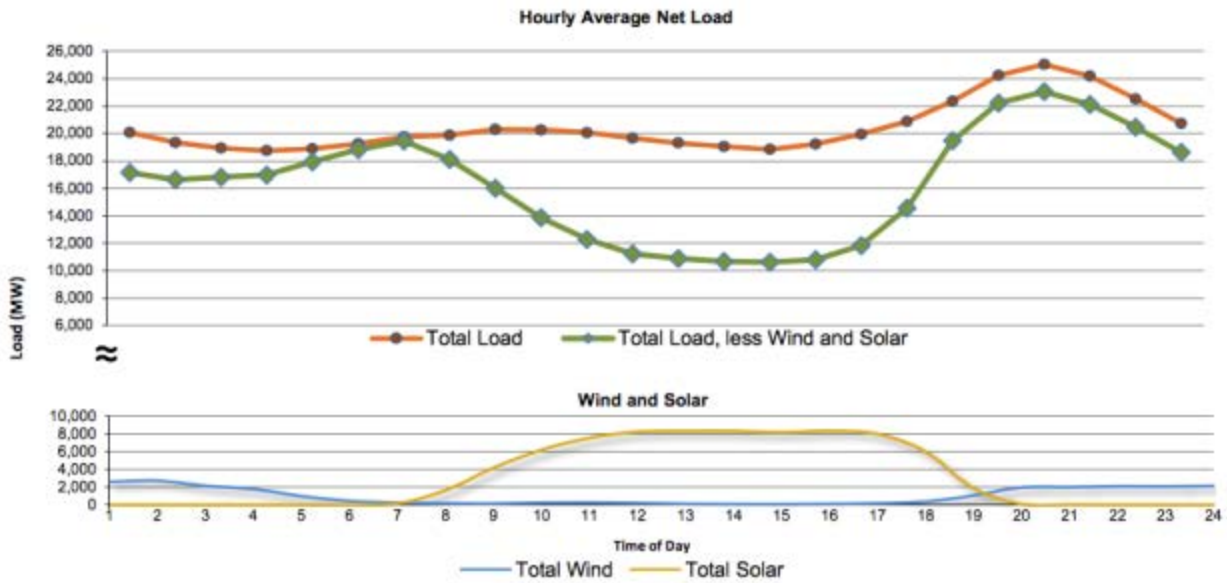

Fig. A.3. Electricity Production (Source: [Daily Renewables Watch, CAISO](#))

While such subsidy strategies can force renewables into the system, there are unintended consequences. Such strategies do not result in a low-carbon system because fossil fuels are used to produce electricity at times of low solar and wind output. The economics overwhelmingly favour use of fossil fuels (particularly gas turbines burning natural gas) because of the low capital costs and fast response speeds of these systems. In some places, such as Germany, renewables have increased carbon dioxide emissions where coal plants provided the lowest-cost backup power while doubling electricity rates to residential consumers. The massive subsidies raise the cost of energy to society. In the case of California those added costs are partly paid by the taxpayer and partly paid by the electricity consumer.

The implications is that society needs low-carbon technologies to productively use excess electricity when generated in a way that minimizes total energy costs to society while minimizing greenhouse gas emissions. An integrated nuclear-renewables system is required.

Appendix B. High temperature Gas cooled reactor (HTGR) with Hydrogen and Variable Electricity Production

B.1. HTGR Development in Japan

Japan began development for HTGR in 1970s [Saito 1994]. The development achieved the first milestone with completing the construction in 1998 of the 30 MWt High Temperature Engineering Test Reactor (HTTR) [HTTR2004]. Today the HTTR has achieved a series of successful operation runs (see Figure 1) that have validated the HTGR of both the plant technologies including fuel, structural graphite, metals and O&M [NED special issues] and the performance features including high temperature (950°C) operation [Fujikawa 2004] and inherent safety such as loss of forced coolant with reactor scram .

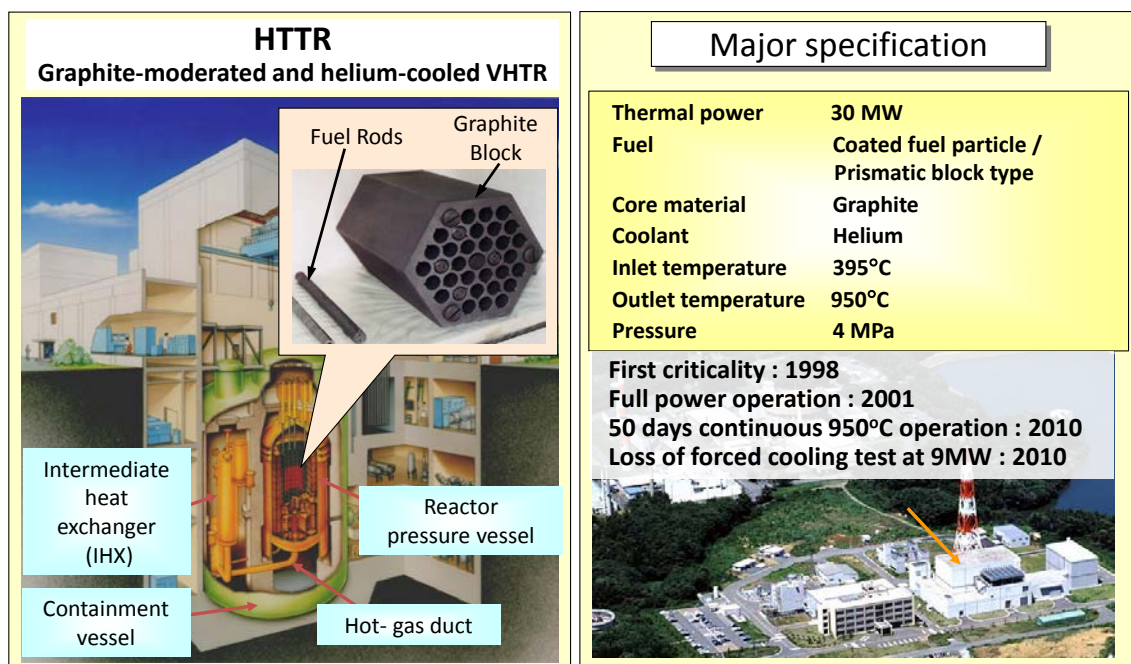

Figure B.1. HTTR – a VHTR test reactor constructed at JAEA Oarai R&D Center

Based on the technologies developed on the HTTR and with additional development for balance of plant technologies, JAEA has proposed a Gen-IV VHTR system design known as GTHTR300C (Gas Turbine High Temperature Reactor of 300 MWe for Cogeneration) as depicted in Figure B.2 [Kunitomi 2007]. Along with power generation by direct cycle helium gas turbine, the system has the flexibility for a range of cogeneration applications such as hydrogen production and desalination [Yan 2014]. Table B.1 summarizes major technical parameters and production performance.

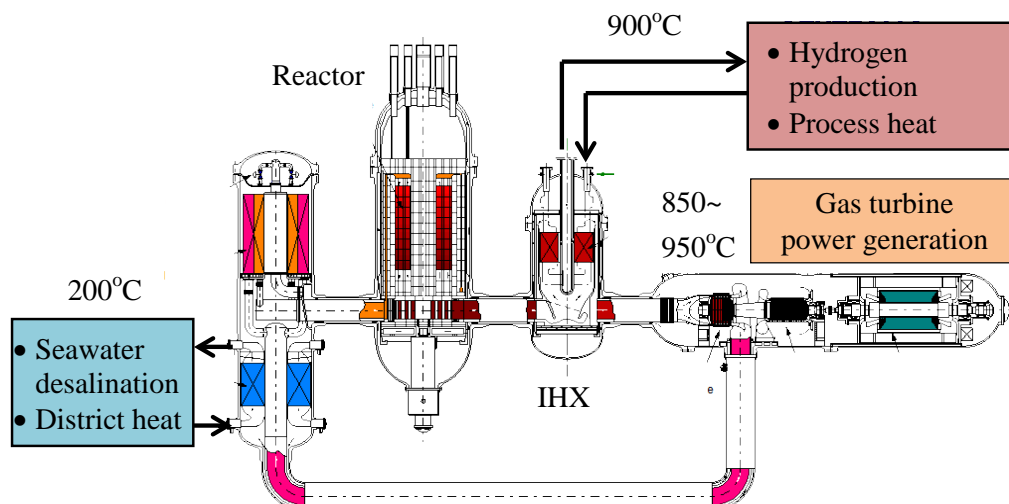

Figure B.2. Japan's VHTR system — GTHT300C with cogeneration options

TABLE B.1. MAJOR TECHNICAL PARAMETERS (GTHT300C)

Technology developer:	JAEA with Mitsubishi Heavy Industries, Toshiba, Fuji Electric, Nuclear Fuel Industry, IHI, Kawasaki Heavy Industries, etc	
Reactor type:	Prismatic HTGR	
Reactor thermal power per unit (MWt):	600	
Reactor coolant temperature (°C):	950	850
Electric power generation [Takei 2006] [Sato		
Net power generation	302	274
Net generation efficiency	50.4	45.6
Cost of electricity	2.87	3.20
Hydrogen cogeneration [Kasahara 2017]		
Power generation rate	204	
H ₂ production rate [Nm ³ /h]	31,863	
H ₂ production efficiency	50.2	
Desalination cogeneration		
Power generation (MWe)	302	274
Desalination (m ³ /d)	49,460	54,550
Overall cogeneration efficiency (%)	87%	84%
Design capacity factor:	>90%	
Design life (years):	40-60	
Coolant:/moderator	Helium/graphite	
Moderator:	graphite	
Primary circulation:	forced circulation	
System pressure:	5-7 MPa	

Reactivity control mechanism:	control rod
RPV height/diameter (m):	23/8
Integral design:	No
Power conversion process:	direct Brayton cycle
Distinguishing features:	Multiple cogeneration applications of power generation, hydrogen production, process
High temperature process heat:	Yes
Low temperature process heat:	Yes
Design configured for process heat	Yes
Safety features:	Inherent
Fuel type/assembly array:	UO ₂ TRISO ceramic coated
Fuel block length (m):	1
Number of fuel columns in core:	90
Average fuel enrichment:	14%
Average fuel burnup (GWd/ton):	120
Fuel Cycle (months):	36-48
Number of safety trains:	2
Emergency safety systems:	inherent
Residual heat removal systems:	inherent
Refueling Outage (days):	30
Modules per plant:	Up to 4 reactors
Estimated construction schedule (months):	24-36
Seismic design:	>0.18 g automatic shutdown
Predicted core damage frequency:	<10 ⁻⁸ /reactor year
Design Status:	Basic design with HTTR and equipment validation

JAEA is developing a test plant of GTHTR300C on the HTTR test reactor [Yan 2017]. The test plant of HTTR-GT/H₂ shown in Figure 3 aims to 1) demonstrate the licensability of the GTHTR300C nuclear cogeneration commercial system described above; 2) confirm the operation control and safety of such cogeneration system; and 3) improve accuracy of cost estimation for such cogeneration system. With construction and operation completion around 2030, the test plant is expected to be the first of a kind HTGR-powered cogeneration plant operating on the two advanced energy conversion systems of closed cycle helium gas turbine for power generation and thermochemical iodine-sulfur water-splitting process for hydrogen production.

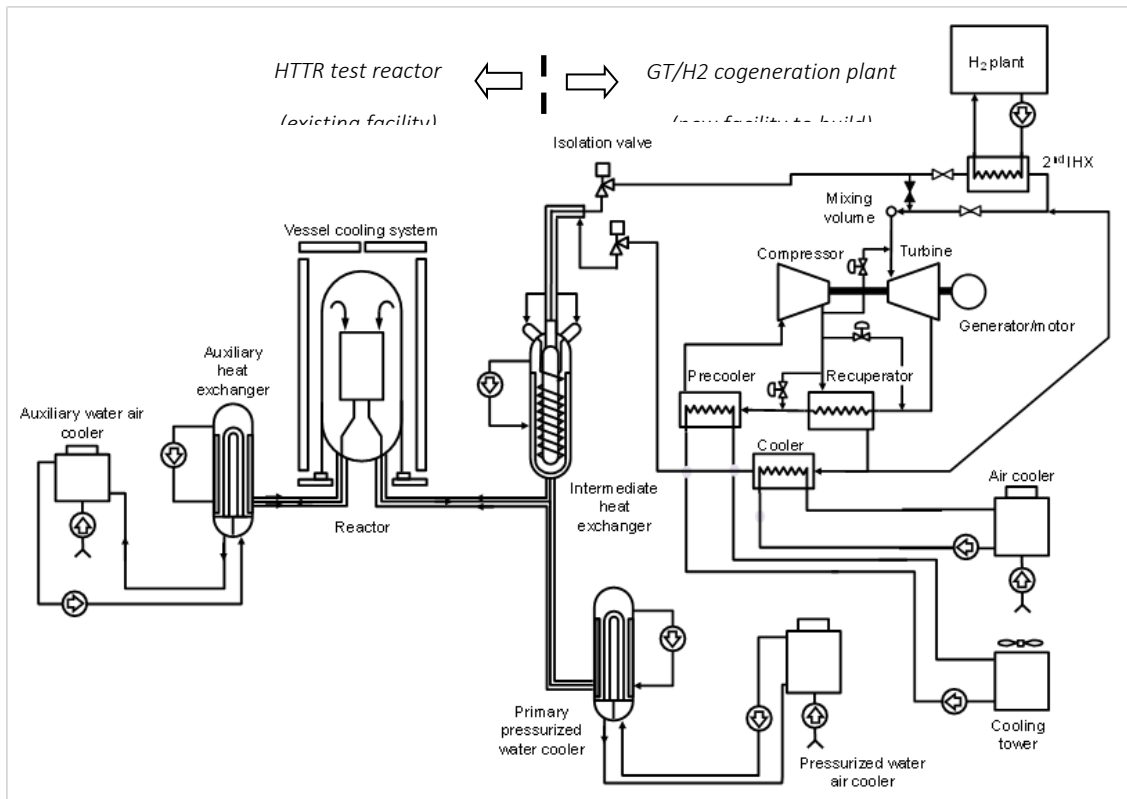

Figure B.3. HTTR-GT/H2 for demonstrating HTGR hydrogen cogeneration on HTTR

B.2. Hydrogen Production

Figure B.4 depicts the principle of the iodine sulfur (IS) process, which involves three inter-cyclic thermo-chemical reactions to decompose water molecules into H₂ and O₂ gas products with high temperature heat and electricity as required energy input and with water as the material feed. All process materials other than water are reagents.

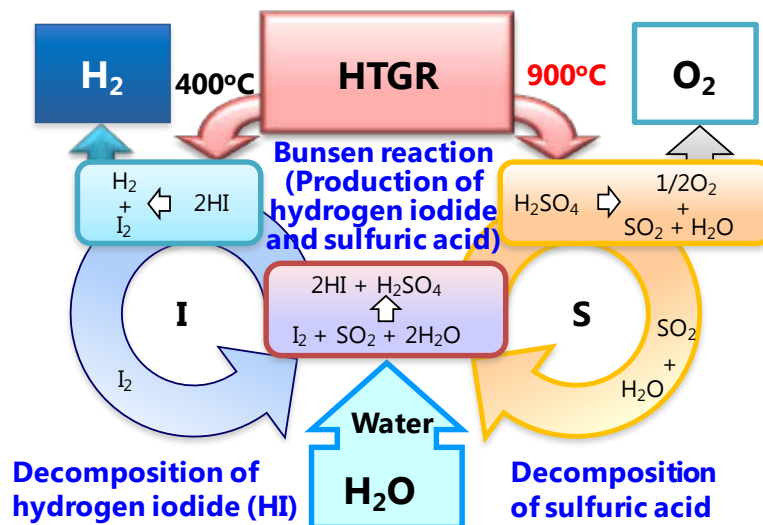

Figure B.4. Principle of thermochemical IS process for nuclear hydrogen production

Although a thermochemical process, the IS process in practice consumes considerable electricity to power hydrogen plant equipment including process pump, gas circulator and fluid processors. The heat to electricity consumption ratio is approximately 7 units of thermal energy to 1 unit of electricity. Further, a centralized large-scale hydrogen production plant serviced by nuclear reactor would consume substantial electricity needed to compress or liquefy hydrogen product for delivery at plant gate. For example, the electricity consumption for liquefaction of hydrogen is approximately 7 MWh per ton of hydrogen.

GTHTTR300C cogenerates both the heat and electricity needed in the hydrogen plant with surplus electricity to be exported and sold to grid. The schematic of the cogeneration plant design [Yan 2011] is shown in Figure B.5. The corresponding production parameters are in Table B.2.

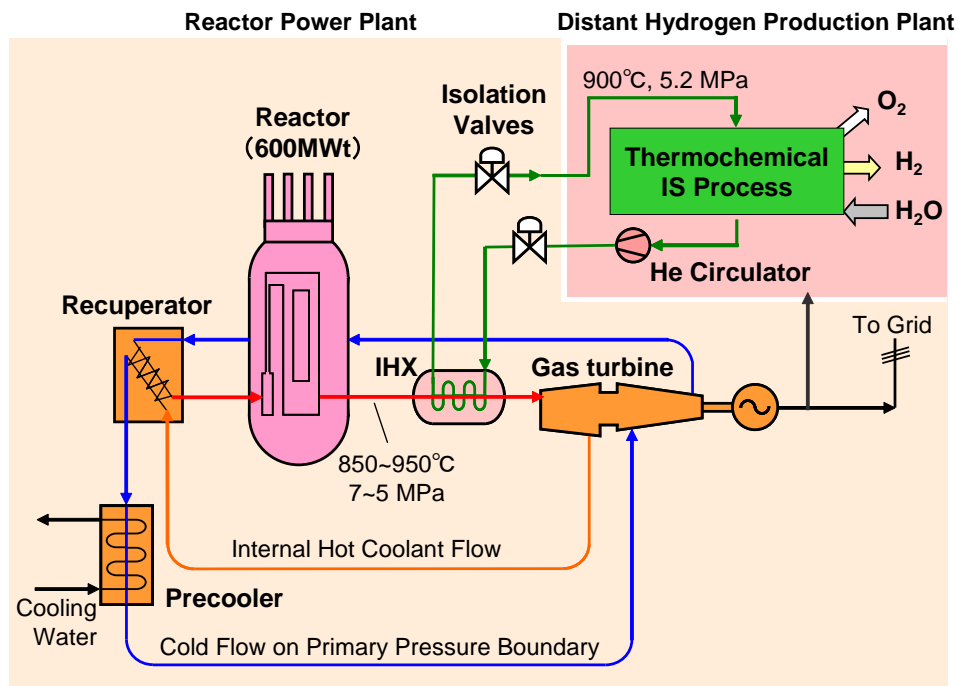

Figure B.5. HTGR-based hydrogen cogeneration process (GTHTTR300C)

TABLE B.2: GTHTTR300C parameter for hydrogen cogeneration and storage

Reactor thermal power	MWth	600
Reactor outlet temperature	°C	950
Gross power generation	MWe	204

Reactor plant elec. load	MWe	6
H ₂ production rate	t/d	67
	Nm ³ /h	31,800
H ₂ plant heat consumption	MWth	170
H ₂ plant elec. consumption	MWe	27.6
H ₂ production efficiency	%	50.1
H ₂ liquefaction elec. consumption	MWe	20.1
Total elec. used for H ₂ production & liquefaction	MWe	48.2
Replacement interval	Year	10-20

Hydrogen production cost is estimated assuming the following site condition:

- The system is a centralized large-scale nuclear hydrogen cogeneration production system sited in Japan.
- Hydrogen is produced is supplied to adjacent industrial user (e.g., oil refinery or chemical plant) on the site.
- Alternatively, an at-gate cost is also given for liquefied and stored hydrogen product, ready to be transported by pipeline or trucks to the users.
- Hydrogen production process is the thermochemical S-I process.
- The cogeneration plant arrangement is GTHTR300C as shown in Figure B.6.

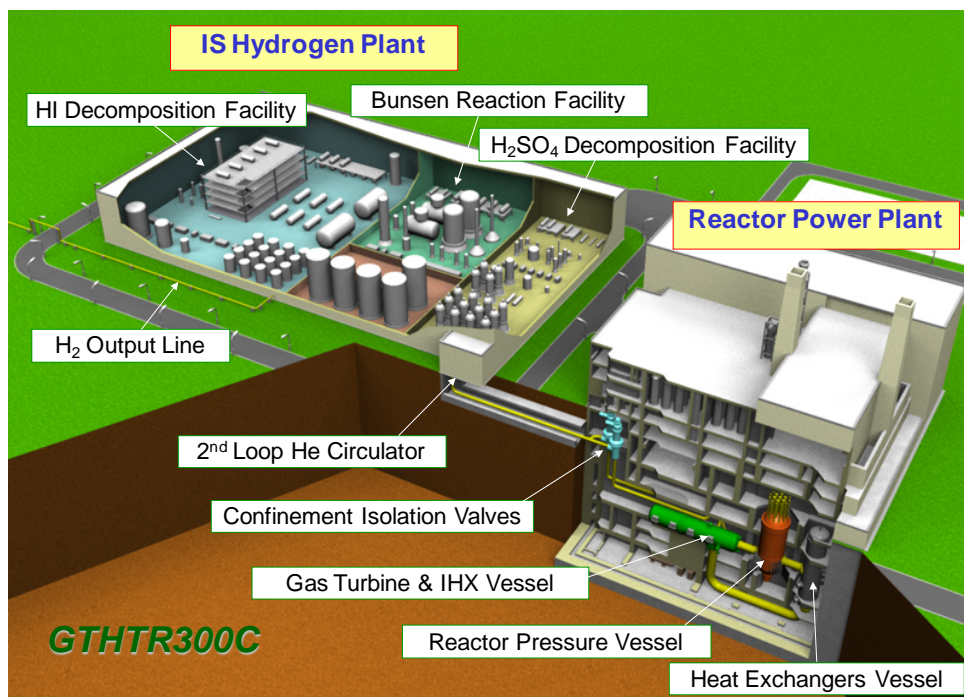

Figure B.6. Nuclear hydrogen cogeneration plant arrangement (GTHTR300C)

Table B.3 lists the financial parameters used in the cost estimation. Discount rate, interest, and property tax are typical values to assess the cost of utility nuclear reactors in Japan. Since the life time of hydrogen plant is 20 years, the cost of one-time replacement of hydrogen plant is considered during the reactor life time.

TABLE B.3. FINANCIAL PARAMETERS

Plant load factor	90%
Reactor plant life time	40 years
Depreciation period	16 years
Residual value	10%
Hydrogen plant life time	20 years (one replacement required)
Depreciation period	10 years
Residual value	10%
Discount rate	3.0%
Interest rate	3.0%
Property tax rate	1.4%

The estimated costs for nuclear plant (power and heat), hydrogen plant, hydrogen storage and transportation as reported [Suzuki 2017] are summarized below:

Nuclear plant cost:

- Thermal rating 600 MWt
- Thermodynamic efficiency 50.4% power generation
0.2% hydrogen production
- Electrical rating 204 MWe
- Capacity factor 90%
- Overnight capital cost US\$456 million
- Construction period 4 years
- Fuel cost US\$10.9/MWh
- O&M costs US\$7.4/MWh
- Decommissioning cost (% of capital cost) US\$1.4/MWh (0.7% of capital-yr)

Costs of nuclear electricity and heat (cogenerated in nuclear plant):

- | | Electricity | Heat |
|----------------|--------------|-------------|
| • Capital cost | US\$11.6/MWh | US\$8.2/MWh |
| • Fuel cost | US\$12.2/MWh | US\$5.6/MWh |
| • O&M cost | US\$8.2/MWh | US\$5.7/MWh |

- Total cost US\$32.0MWh US\$19.4/MWh

Hydrogen plant cost

- Hydrogen production rate 22,500 t/year
- Thermal energy required 170.0 MWt
- Electricity required 27.5 MWe
- Overnight capital cost US\$427 million
- O&M costs US\$0.21/kg-H2
- Decommissioning cost (% of capital) 10%/capital

Hydrogen cost (\$/kg-H2):

- Capital cost (include only hydrogen plant capital cost, \$/kg) US\$0.58/kg
- Energy cost
 - Total US\$1.47/kg-H2
 - Electrical energy US\$0.31/kg-H2
 - Thermal energy US\$1.16/kg-H2
- Other operating costs for hydrogen plant US\$0.21/kg-H2
- Cost of H2 production US\$2.26/kg-H2

Hydrogen storage and transportation

- Onsite hydrogen storage capacity 26,915 kg
- Compressor/liquefier electricity requirement 277,000 kWe
- Overnight capital cost US\$2,127 million
- Operating cost US\$122 million (5.7%/capital)
- Cost of onsite liquefaction/storage US\$0.65/kg-H2
- Cost of liquefied H2 at plant gate US\$2.91/kg-H2

B.3. Hybrid production system by HTGR

In a preliminary study, the ability of GTHTR300C to absorb unsteady power changes of various time scales in renewable energy for the purpose of grid stability is evaluated in a hybrid system arrangement shown in Figure B.7.

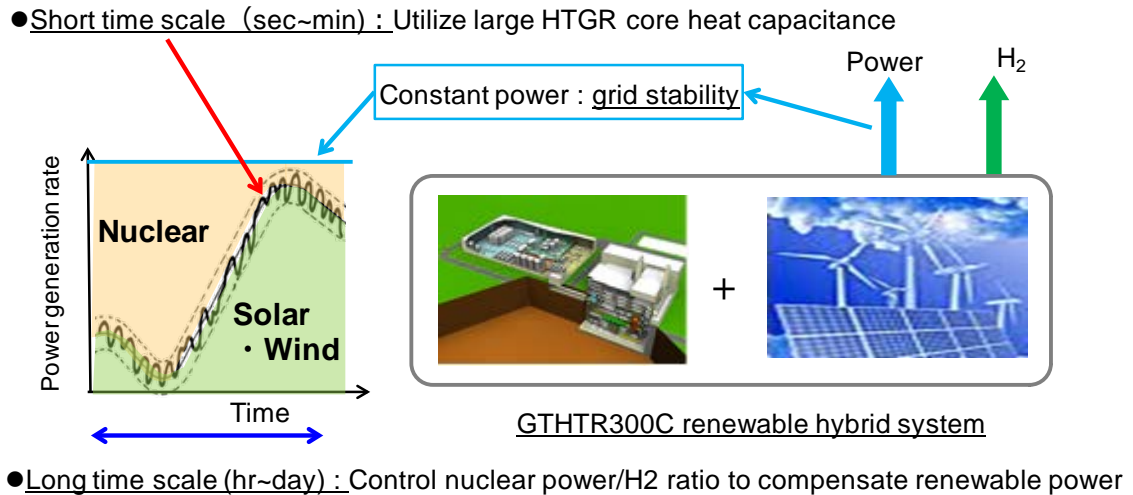

Figure B.7. HTGR renewable energy hybrid system for grid stability

Variations in hour and day time scale

In response to renewable power generation variations in hour and day time scale associated with solar system and often with wind system, the following strategies are employed for the control of nuclear plant designed to maximize nuclear plant economics while minimizing undesired impact of the frequent load-following on nuclear reactor:

- (a) Maintain constant reactor thermal power operation
- (b) Minimize transient thermal stress in reactor internal components
- (c) Minimize transient thermal stress in turbine blades
- (d) Maintain the high thermal efficiency of power generation

Accordingly, the following four control methods are integrated in the design of an automated control system for the GTHTR300C (Figure B.8):

- (a) Reactor coolant inventory control
- (b) Turbine inlet temperature control
- (c) IHX heat rate control
- (d) Reactor outlet temperature control

In response to the renewable power variation, nuclear reactor helium coolant is taken in or out of the primary circuit using coolant inventory control system. Simultaneously, IHX heat rate for the hydrogen plant is adjusted by secondary helium flow rate. In addition, load follow control valve is adjusted to keep turbine inlet temperature unchanged. This sequence of control is evaluated by RELAP5 simulation with the results

in Figure 9. As seen, the reactor power and power generation efficiency are kept constant at all time as intended.

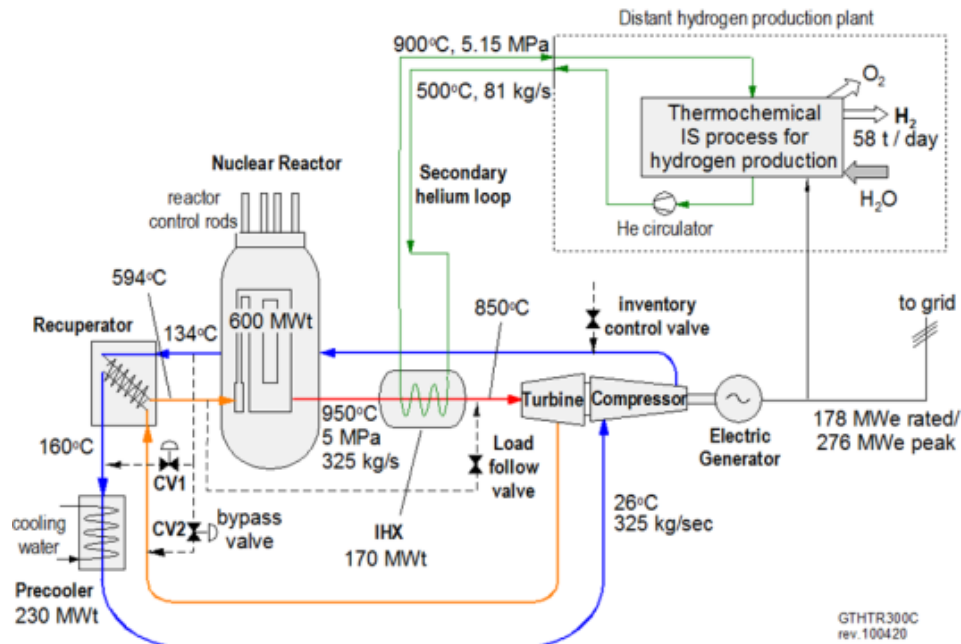

Figure B.8. Basic control scheme for GTHT300C

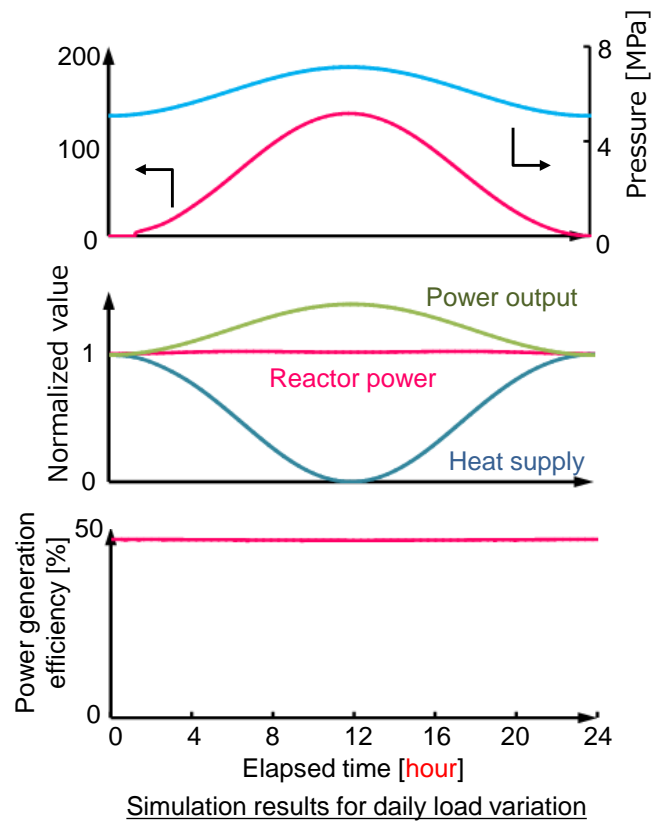

Figure B.9. Reactor response to daily renewable power generation variation

Variations in minute and second time scale

The operation strategy for the nuclear reactor to accommodate renewable power generation variation in minute or second time scale associated mainly with wind system take the advantage of intrinsic design feature of the HTGR core having a huge thermal capacitance due to massive amount of graphite used in the reactor core. For example, the core of the 600 MWt HTGR has a thermal capacity of 373 MJ/K.

In addition, turbine speed is kept constant due to large grid connection. In case of absence of a large grid, turbine speed will be maintained by turbine flow bypass (CV1). Furthermore, the control power control rods are not moved in response to small changes of reactor outlet coolant temperature to be encountered assuming that renewable power disturbance at short time scale is limited within $\pm 20\%$ of nuclear rated power.

Figure B.10 is the simulation of nuclear reactor operation to renewable power change at the minute scale and Figure 11 is the simulation of the same to the second scale. As can be seen, the reactor fission thermal power remains essentially constant at all time where the power generation of the reactor is varied by the extraction and storage of the heat in the reactor core to increase or decrease turbine power generation output. The power generation efficiency is slightly changed because of the turbine bypass used to maintain turbine speed, instead of assuming connection to large external grid.

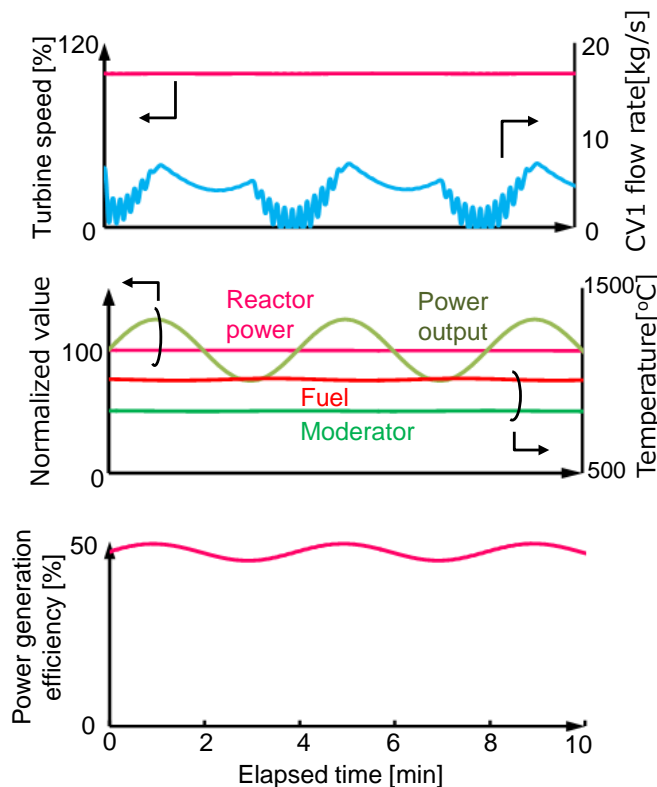

Figure B.10. Reactor response to renewable power generation variation of minute scale

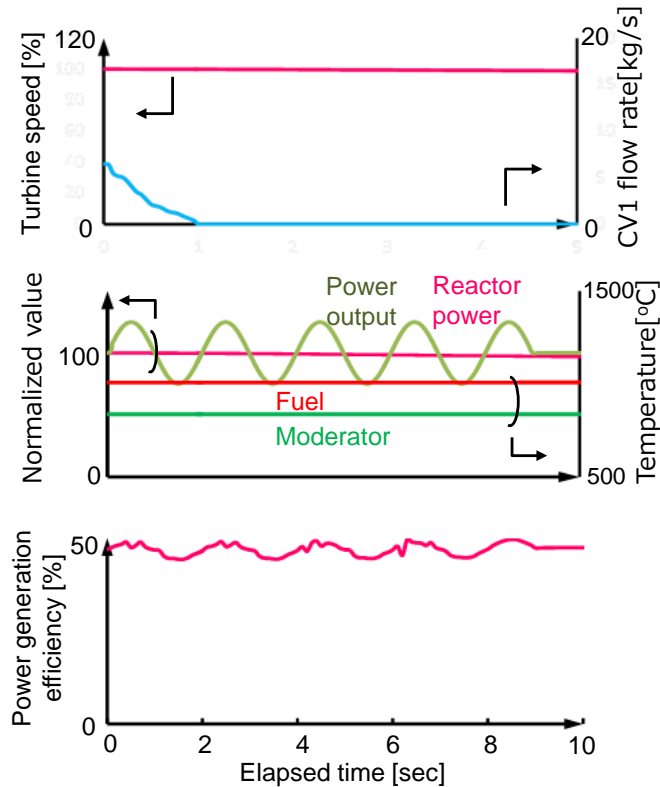

Figure B.11. Reactor response to renewable power generation variation of second scale

References

- Fujikawa, S. et al., 2004. Achievement of reactor-outlet temperature of 950oC in HTTR, Nucl. Sci. Tech. 41(12) 1245-1254 (2004)
- HTTR, 2004. Topic Issue on Japan's HTTR, Nucl. Eng. Des. 233(2004)
- Kasahara, S. et al., 2017. Conceptual design of iodine-sulfur process flowsheet with more than 50% thermal efficiency for hydrogen production, Nucl. Eng. Des. 2017.
- Kunitomi, K. et al., 2007. JAEA's VHTR for Hydrogen and Electricity Cogeneration: GTHTTR300C," Nuclear Engineering and Technology, 39(1), 9-20 (2007).
- M. Takei, et al., 2006. Journal of Nuclear Science and Technology of Japan, Vol. 5, No. 2, p.109-117 (2006)
- Suzuki, Yan, et al., 2017. Economics evaluation of nuclear hydrogen production with GTHTTR300C. Journal of Nuclear Science and Technology of Japan, submitted (2017)
- Saito, S., et al., 1994. Design of High Temperature Engineering TestReactor (HTTR). JAERI, 1332 (1994).
- Sato, H., et al., 2014 GTHTTR300 — a nuclear power plant design with 50% generating efficiency, Nucl. Eng. Des. 275, 190–196(2014)

- Yan X, 2011. Nuclear Hydrogen Production Handbook, CRC Press, Florida, USA, 2011
- Yan X., et al., 2014 A Hybrid HTGR System Producing Electricity, Hydrogen and Such Other Products as Water Demanded in the Middle East, Nucl. Eng. Des. 271(2014).
- Yan, X. et al., 2016 GTHTTR300 cost reduction through design upgrade and cogeneration, Nucl. Eng. Des. 306, 215-220 (2016)
- Yan, X. et al., 2017 HTTR-GT/H₂ test plant – system design, Nucl. Eng. Des. (2017)

Appendix C. Case Studies of Global Hydrogen Demand/Supply from Low-Carbon Resources Toward 2050

Case 1

A global projection of CO₂-free hydrogen energy supply and demand toward 2050 was studied and evaluated using a global and long-term intertemporal optimization energy model (GRAPE) under severe CO₂ emission constraints (Y. Ishimoto, 2015). CO₂-free hydrogen is assumed to be produced in all global regions and transported to other regions by electrolysis by power from low carbon power generation sources (solar, wind and hydro, but no nuclear energy), and by syngas processes with fossil fuels of low grade coal and natural gas with CCS.

The assumptions to utilize hydrogen are;

(a) Power Generation

Efficiency of hydrogen fired power plant: the same as natural gas fired power plants (approximately 57% at LHV basis).

Capital cost: 1960USD/kW

Capacity factor: 85%

Advanced hydrogen fired power plant with only hydrogen and oxygen after 2030.

Efficiency: 63.4% (in 2030), 64.5% (in 2050)

Capital cost: 2542USD/kW[2]

Capacity factor: 85%

(b) Delivery cost

For transport and stationary use: 703\$/toe (equivalent to 2020 DOE target)[3]

Delivery loss of hydrogen: 10% for transport and stationary use, 0% for power generation

For Japan, the higher costs are assumed mainly due to regulations.

For transportation: 5,226 in 2020 and 1,455\$/toe after 2030

For stationary use: 1,713 in 2020 and 750 \$/toe after 2030

(c) LDV (Low Duty Vehicle) type

FCV, hydrogen ICE, Biofuel ICE, EV are deployed after 2020.

Tank to wheel efficiency of FCV: 57%

Cost (USD/vehicle) 46,048 in 2020, 31,990 in 2030

(d) Hydrogen CHP

Stationary fuel cell (FC), Hydrogen gas turbine CHP (H2GT), hydrogen gas engine CHP (H2GE) [4]

CHPs are deployed after 2020.

Electricity and heat from FC are constrained up to 50% of the residential and commercial demand and hot water demand, respectively.

Electricity and heat from CHP in industry is constrained up to those of industry demands.

(e) Direct combustion

Hydrogen is assumed to be mixed with natural gas up to 20 vol % .

The above set of conditions to fifteen regions world energy optimization model has yielded approximately 900Mtoe/year of hydrogen demand globally under the climate policy case of CO₂ constraint in 2050, which is reduction by half worldwide (Fig.1). It was assumed that hydrogen is mainly produced from lignite gasification with CCS and electrolysis by means of hydro and wind electricity. 20% of global primary energy supply is used for hydrogen production in 2050. A major part of hydrogen is utilized in the transportation sector especially for LDVs and trucks

in 2050 (Fig.1). In the transportation sector, the share of hydrogen is 20% in 2050. CCS used for hydrogen production contributes 11% of CO2 reduction in 2050 (Fig.2).

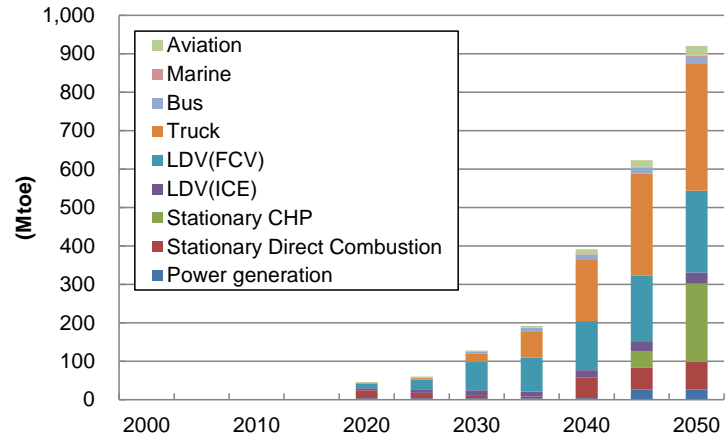

Fig.C.1. Share of global hydrogen demand in the climate policy case.

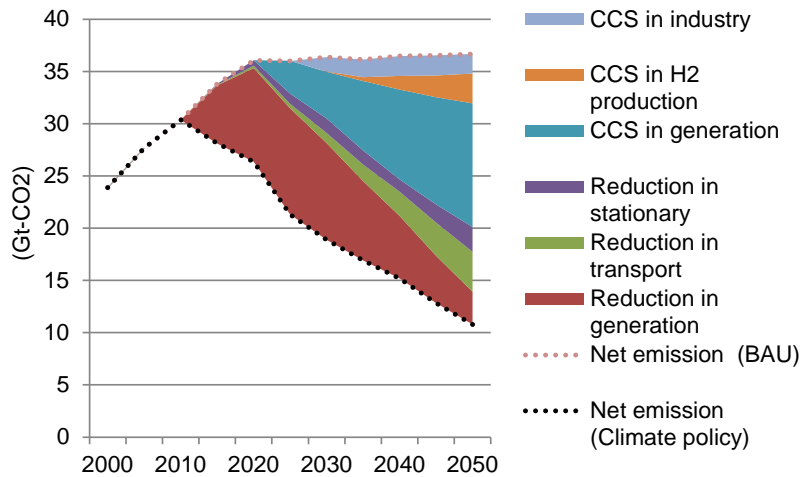

Fig. C.2. CO2 emission reduction contributions in the world

The above analysis focuses mainly low grade coal utilization for hydrogen source and, power generation with CCS and vehicle fuel as hydrogen usage. Therefore the above results are caused by the favorable conditions of prices of coal and huge availability of CCS, and with limitation to nuclear utilization, even though hydrogen price is more than double of oil in oil equivalent base.

If we assume use of nuclear power, the story will be different. An example of nuclear hydrogen system with steel industry is described and proposed in the following section, and the essential components of its nuclear hydrogen system can replace the coal process with problematic CCS of the above world energy system.

Case 2

The above study focuses on hydrogen utilization for power and transportation, and industry through CHP. But, as for the case of Japan in FY2014, more than one third of CO2 emission of 426 million tons per year was due to industry. Steelmaking is the biggest emitter in the industry by 190 million tons which is about 15% of total CO2 emission by Japan, almost close to the emission of transportation sector of 17%. Major source of CO2 is blast furnaces which utilizes cokes made of coal to reduce iron ore to steel. Carbon or fossil fuels are used for iron ore reduction

Annual Emission by Japan in FY 2014

Total Greenhouse gas	1,364 million tons	
CO2	1,265	100%
CO2 energy related	1,189	
Industry total	426	33.7%
Steel	190	15%
Chemical	67	5%
Cement	40	3%
Transportation	217	17%

Currently, steelmaking by blast furnaces with cokes is most common due to large scale production capability and longtime experiences, but direct reduction by hydrogen has less practice perhaps due to economics. If we replace cokes by hydrogen, CO2 reduction effect is most apparent. The idea is the combination of high temperature reactor, direct water decomposition process utilizing high temperature media from nuclear reactor and shaft furnace with hydrogen replacing blast furnace. One such study (Dr. X.L. Yan et al in 2012) is based on 600 MWt GTHTR300C (Gas Turbine High Temperature Reactor of 300 MWe for Cogeneration) designed by JAEA and using IS process for hydrogen production by water splitting.

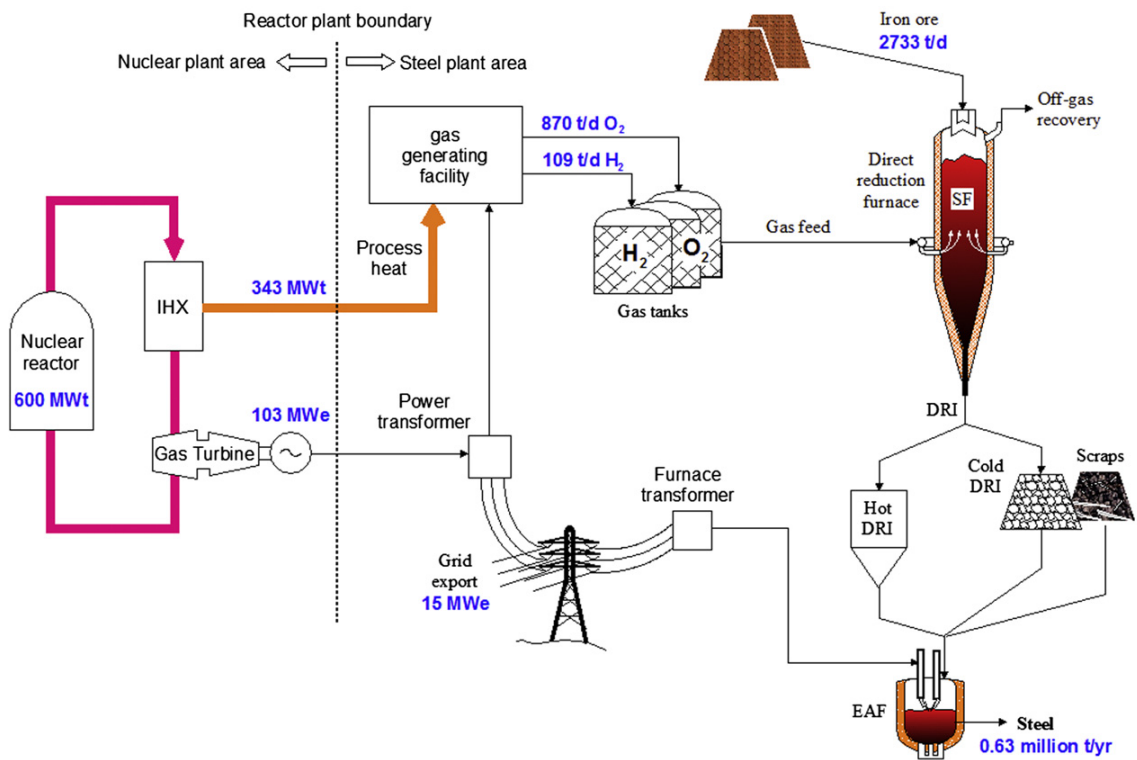

Fig. C.3. Schematic of GTHTR300C nuclear steelmaking system based on a unit of nuclear reactor

Basic plant parameters of the nuclear steel system based on 600 MWth HTGCR are summarized below.

Plant parameters	Values
Reactor power	600 MWt
Coolant outlet temperature	950 _C
Coolant pressure	5.2 MPa
Turbine inlet temperature	750 _C
Heat generation	343 MWt @ 900 _C
Power generation	103 MWe
Hydrogen production	109 t/d
Oxygen production	870 t/d
Steel production	628 kilo-t/yr
Steel cost	US\$628/t-steel
CO2 emission	13.8 kg/t-steel

According to the balance of the above system, about 57% of nuclear heat to produce hydrogen by water splitting process (IS) and the other 43% for power production. But almost 90% of electricity produced is used by electrolysis in the IS, and electric arc furnace which treats direct reduction ingot from shaft furnace to make steel of 628,000 tons per annum. Some oxygen is byproduct from the process but power to export is small, 15 MWe.

In recent years, Japanese steel annual production stays at around 80 million ton. It is not realistic to assume all the blast furnaces to be replaced by shaft furnaces with HTGCR, of course. But about 130 sets of the above configuration can theoretically eliminate about 15% of Japanese CO₂ emission.

References

- [1] Ishimoto Y. et al., Sensitivity Analysis of Global Hydrogen Demand from Low-Carbon Resources toward 2050. Hydrogen Power Theoretical and Engineering Solutions International Symposium 2015, Toledo, Spain. 6-9 September 2015
- [2] NEDO, Report of WE-NET Subtask 3, NEDO-WE-NET-9431 (1996) (in Japanese, Abstract in English available).
- [3] US DOE, Fuel Cell Technologies Program Multi-Year Research, Development and Demonstration Plan (2014)
- [4] International Energy Agency, Energy Technology Systems Analysis Program, Technology Brief E04 Combined Heat and Power.
- [5] X.L. Yan et al. Study of a nuclear energy supplied steelmaking system for near-term application/ Energy 39 (2012) 154e165

Appendix D: Reactor Heat Storage Options for Base-Load Reactors with Steam Cycles for Variable Electricity and Steam Output

Energy markets are changing with the need for dispatchable electricity. There are two storage options to match energy demand with energy production using the full production capacity of high-capital-cost low-operating-cost nuclear, wind, and solar: work and heat. Work and heat are fundamentally different—the basis of much of power engineering that is about converting heat into electricity. Photovoltaic solar and wind produce electricity, a type of work. These technologies logically couple to work storage devices include pumped hydro (gravitational energy), batteries (chemical energy) and flywheels (kinetic energy). Nuclear and solar thermal systems produce heat that is then converted into electricity (work). While nuclear reactors and solar thermal systems can produce electricity that is then stored, thermal energy storage is potentially one to two orders of magnitude less expensive than storing work. This creates the option to couple nuclear plants to heat storage for variable energy production.

Heat storage can be coupled to any type of reactor. However, heat storage options have only been explored in any detail for coupling to light-water reactors (LWRs)—the current technology. We describe options that are under development to store heat from reactors at times of low electricity prices to produce added electricity when needed while the reactor operates at base-load to minimize total energy costs to society. Most of these options can also store heat for later use by industry. Some of these technologies have been deployed in solar thermal power systems [Kuravi, 2013] while other technologies are primarily in the research stage. A recent workshop [Forsberg, 2017a] at MIT addressed heat storage coupled to LWRs that provides the basis for considering such options

D.1. Reactor Constraints

Economic and technical considerations impose constraints on LWRs and any other reactor with heat storage.

Constant full reactor output. To minimize costs of energy production and minimize operational challenges, the high-capital-cost low-operating-cost reactor should be operated at full power at all time. The steam from the reactor can be divided between the main turbine and the heat storage system.

Minimum electricity to the grid. For the power plant to maintain its capability to rapidly send 100% of its rated capacity to the grid, the main turbine must remain online, which requires a certain minimum steam flow to the turbine even when the energy storage system is being charged. Typically minimum power to the grid is near 30%. However, in many existing nuclear plants instabilities in the balance of plant (BOP) limit the minimum power to the grid to about 60% to 70% implying 30% to 40% of the steam is going to the storage system. With new plants or changes in existing plants, the minimum power level can be much lower. If the main turbine is shut down, it may be hours before it can be put back on line.

There are several implications of operating the power conversion system at part load and the reactor at full power. First, the power plant can respond to rapid changes in electricity price to maximize revenue. Second, the plant can provide some auxiliary services such as frequency control. There are costs. The efficiency of the main steam plant goes down as the load goes down (Fig. D.1).

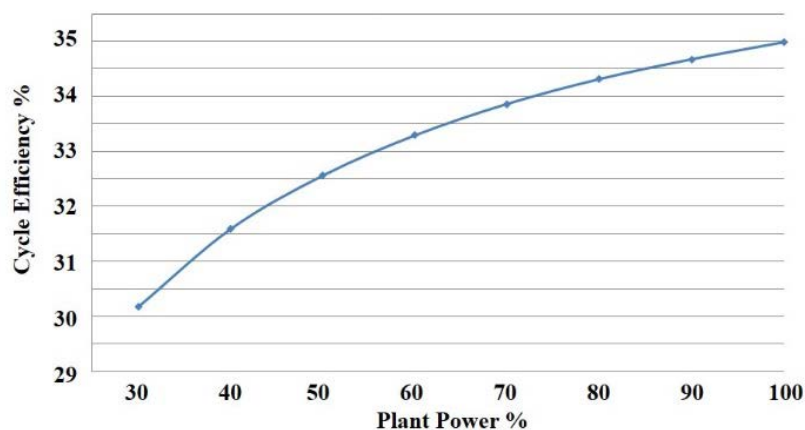

Fig. D.1. Typical 1200 MWe Pressurized Water Reactor Plant Cycle Efficiency vs. Power Level.

Courtesy of Westinghouse Corporation

- *Maximum electricity to the grid.* This is equal to the base-load capacity of the power plant plus the power output from the energy storage system. For some technologies this output can be 2 to 3 times the base-load electricity output. It is a design variable.

The other consideration is how to couple the LWR to the heat storage system. There are two broad sets of options with many variants. In Europe and Asia a number of LWRs produce steam for electricity and off-site customers, so there is considerable real-world experience in nuclear plants producing electricity and exporting heat [IAEA, 2017].

Stand-alone Storage Systems. With this option steam is diverted before the high-temperature turbine and sent to the storage system that has its own power generation system. Condensate water is returned to the reactor. The steam is diverted before the high-temperature turbine because steam from the reactor is at a constant pressure and temperature. Steam diverted from other locations in the turbine hall has variable temperature and pressure depending upon plant operations.

There is relevant experience in the United States about what is required to do this. About a decade ago, the Fort Calhoun Nuclear Power Plant did detailed engineering and cost studies, including discussions with the Nuclear Regulatory Commission, on diverting some of its steam to a nearby Cargill industrial plant with return of the condensate water to the reactor. The conclusion is that this was practical, economic, and had no significant impact on safety. The project did not go forward for other reasons. In some other countries steam is sold to industrial customers—identical to what is required.

Integrated Storage Systems. With this option steam is diverted to storage at times of low demand and heat is sent back to the turbine hall at times of high demand to produce added electricity. The main turbine is used to produce the added electricity. This option has two advantages.

- Incremental capital cost to the power cycle for added electricity output is significantly lower than with a stand-alone power system coupled to heat storage.
- The main turbine is always operating, which enables fast response to changing electricity demand.

There are disadvantages. There are practical limits on the peak power relative to base-load power—perhaps 20% higher. The peak turbine efficiency varies with load so that efficiency will be lower at either base-load or the peak power level. Last, this option is easy to design into a new plant but the ability to economically modify an existing plant depends upon the specific plant.

The characteristics of LWR steam cycles provide multiple options on how to integrate heat storage into the power cycle. Some of those options are shown in Fig. D.2 [Forsberg, 2017a]. Up to a third of the steam from the reactor is diverted from the turbines in different locations to feed-water heaters to improve plant efficiency. The different feed-water heaters operate at different temperatures. Stored heat can be sent back as steam to the main turbine or to the feed-water heaters to allow more primary steam to the turbines. Design considerations will be further addressed in Section D.3.

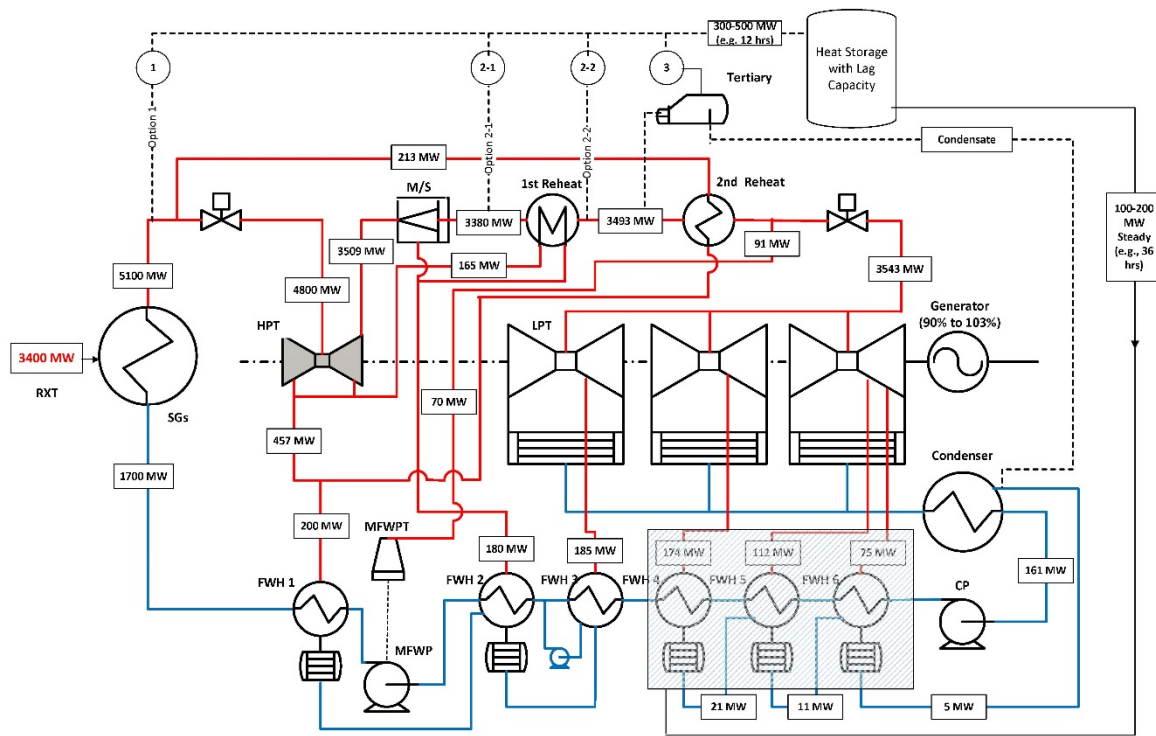

Fig. D.2. PWR Steam Plant with Selected Options for Steam Removal and Return to Turbine Plant

Heat storage can be coupled to any type of reactor. However, heat storage options have only been explored in any detail for coupling to light-water reactors (LWRs)—the current technology. The workshop focused on LWRs because they are the dominant reactor type worldwide. The same storage technologies apply to all other water-cooled reactors with steam cycles and, with some constraints, to other reactors with steam cycles.

D.2. Thermal Storage Options

Six classes of storage technology options that couple to LWRs were examined, where steam is the input to the storage system... Some of these technologies have been deployed in solar thermal power systems [Kuravi, 2013] while other technologies are primarily in the research stage. Most new utility-scale solar thermal power systems [Harvey, 2017] include heat storage to avoid selling electricity at times of low prices. The storage times for different technologies vary from hours to seasons.

D.2.1. Steam Accumulators (Direct hot water/steam storage)

A steam accumulator is a pressure vessel nearly full of water that is heated to its saturation temperature by steam injection (Fig. D.3). Heat is stored as high-temperature, high-pressure water. In addition to its fairly high thermal conductivity, liquid water has a high volumetric heat storage capacity of up to 1.2 kWh/m³ [Medrano et al., 2010]. When steam is needed, valves open and some of the water is flashed to steam and sent to a turbine [LaPotin, 2016], producing electricity, while the remainder of the water decreases in temperature.

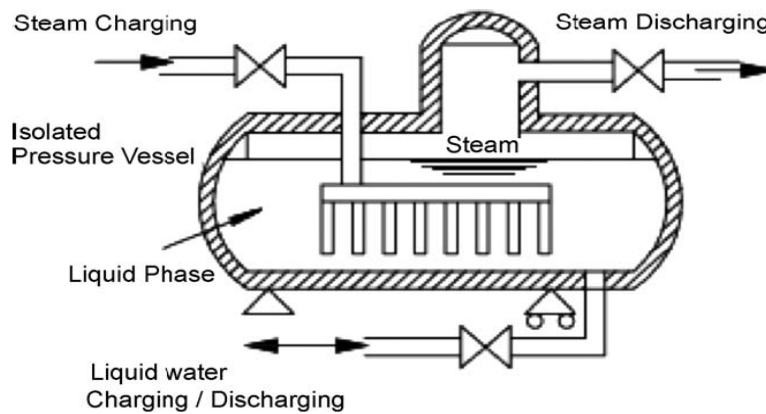

Fig. D.3. Steam Accumulator Schematic

Steam accumulators have been used as pressure buffers in steam plants for over a century. The first large steam accumulator built to produce peak electricity was the Charlottenburg Power Station. It was built in Berlin in 1929 with a peak electricity output of 50 MWe and a storage capacity of 67 MWh. The steam was provided by a coal-fired boiler and the accumulator had a separate turbine. This accumulator had 16 tanks each 4.3 meters in diameter and 20 meters high (Fig. D.4). There are multiple commercial suppliers of steam accumulators—but not at the size that would be associated with a LWR.

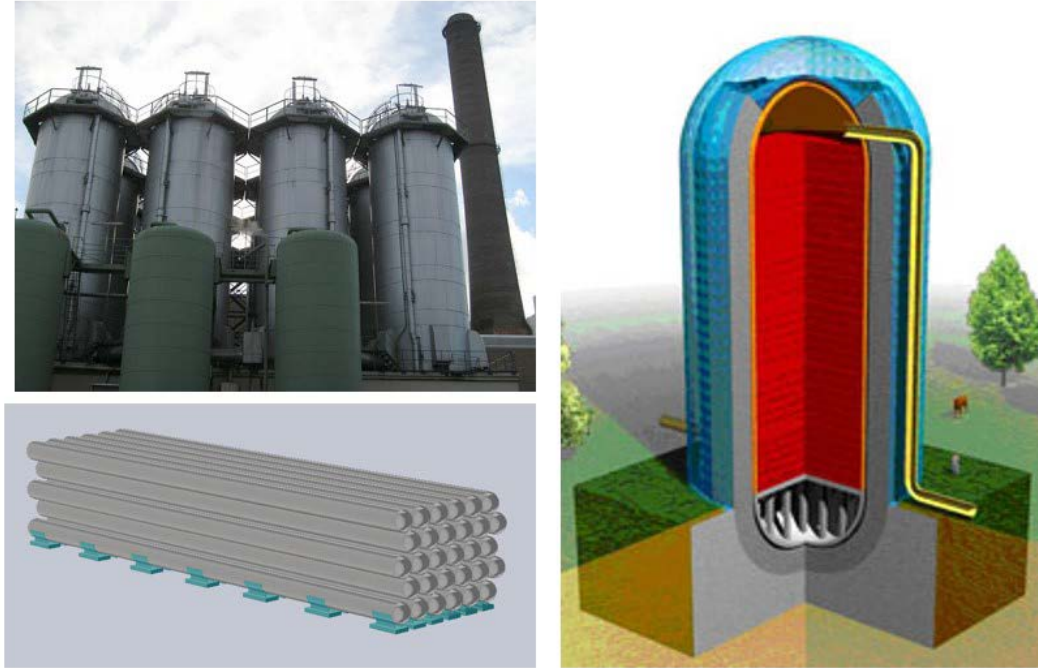

Fig. D.4 Alternative Accumulator Options: Steel Vessel Charlottenburg Power Station Accumulators Built in Berlin in 1929 (Upper Left), Proposed Pipe Rack Accumulator (Lower Left) and Prestressed Concrete Vessel (PCV) (Right, Proposed Adele PCV for Adiabatic Compressed Air Storage System [Zunft, 2014]; Schematic (right) courtesy of Zublin).

Steam accumulators have been installed in many concentrated solar power plants. The characteristics of some of these systems are shown in Table D.1. Steam accumulators are well-suited for CSP designs where steam is generated in pipes located at the foci of parabolic or Fresnel reflectors [Steinmann, 2006; Hirsch, 2014]. At the PS-10 and PS-20 plants near Seville, Spain, steam accumulators are coupled to the steam loops for heat storage, allowing them to produce electricity at times of high prices and low sunlight [Kuravi, 2013]. The operating temperatures and pressures of the solar power systems are close to those in LWRs (up to 400 °C, 100 bar).

Most of the energy in a steam accumulator is stored as pressurized hot water because the energy storage density is higher. For a 100 MWh of electricity storage with steam delivered from 70 to 20 bars, one needs to store the equivalent of about 1000 tons of steam (286°C, 70 bar) that would occupy 27,000 m³. The same energy is stored in 7900 m³ of pressurized hot water or a reduction in storage volume by 3.4.

Table D.1. Solar Power Accumulators [Han, 2009; NREL, 2017]

Name	Location	Online	Type	HTF	Outlet [°C/MPa]	Power [MW _e]	Energy		
							Cap. [hours]	Sensible TES	Latent TES
PS10	Sevilla, Spain	2007	CSP Tower	Steam (DSG)	250/4.5	11	0.5	N/A	Steam acc.
PS20	Sevilla, Spain	2009	CSP Tower	Steam (DSG)	250/4.5	20	0.5	N/A	Steam acc.
DAHAN	Beijing, China	2012	CSP Tower	Steam (DSG)	400/4.5*	1	1	Mineral oil	Steam acc.
Khi Solar One	Upington, South Africa	2016	CSP Tower	Steam (DSG)	530/4.5*	50	2	N/A	Steam acc.
eLLO	Llo, France	(2018)	CSP Linear Fresnel	Steam (DSG)	285/7.0	9	4	N/A	Steam acc.

There are two classes of accumulators. The variable pressure (Ruths) accumulator is a single tank accumulator with sliding pressure during operation. It is the primary type of steam accumulator in current use. There is a more complex expansion accumulator that may be of interest for very large accumulators but is not generally used. The expansion accumulator involves two tanks: an accumulator tank that operates at constant pressure and an evaporator tank that delivers constant pressure steam. During discharge hot pressurized water is transferred from the accumulator tank to the expansion tank while cold water is added at the bottom of the accumulator tank to maintain a constant pressure with a thermocline separating the hot and cold water.

Steam accumulator performance can be improved by adding other heat storage materials to the system. Phase-change materials (PCM) like sodium nitrate salts can be added within or around the stored water–vapor mixture to increase the total heat capacity of the system. During charging, heat is stored by melting the PCM (enthalpy of fusion), and it is released back into the water–vapor mixture during discharge, re-solidifying the PCM. Additional heat could be stored in sensible heat storage materials (e.g., high-temperature concrete) for preheating condensate water or for reheating or superheating steam from the accumulator. Reheating may be necessary in some designs to improve the steam quality that feeds into the turbine [Birnbaum et al., 2010]. A demonstration project for these concepts was built at the Litoral de Almería coal-fired power plant in Spain [Laing, 2011] to support steam accumulators for solar thermal power systems.

There have been limited studies of coupling steam accumulators to nuclear power plants for load following. Early studies [Gilli, 1970; Gilli, 1973] of such accumulators coupled to LWRs were done in the 1970s when the Arab oil embargo raised oil prices—the fuel used for peak power production. The University of Texas has recently conducted a series of studies on the use of accumulators. This included

steam accumulators [Lane, 2016; Bisett, 2017] that can provide heat to the feed-water heaters in the nuclear plant and boost the power output of the main nuclear steam turbine. Mann [2017] examined the economics in the context of the Texas electrical grid to determine under what conditions the economics were favorable.

The defining feature of a steam accumulator for nuclear applications is the required heat storage capacity—significantly larger than for other applications. This will not change the technology for the power cycle but may change the technology used to store the hot pressurized water. Historically, steel vessels have been used. For very large accumulators there are two other options that may have lower costs per unit volume (Fig. D.4).

- *Steel pipe.* Recent studies have proposed kilometers of large steel pipe in racks inside an insulated building to avoid insulation of individual racks. Steel pipe used in pipelines is manufactured in very large quantities that will minimize manufacturing costs.
- *Prestressed concrete reactor vessel.* This would be a single large vessel. There has been recent work in Germany in development of such vessels as a component of an adiabatic compressed air storage system (Project Adele) at higher pressures and temperatures than in steam accumulators. The basis for that work is the lower projected costs for high volume storage at pressure. This work is directly applicable to steam accumulators.

D.2.2. Heat Storage (oil, salt, etc.) In Secondary Low-Pressure Media

Sensible heat storage [Fitzhugh, 2016; Edwards, 2016; Frick, June 2017; Frick, October 2017] involves heating a second fluid with steam or hot water, storing that second hot fluid at or near atmospheric pressure, and using that hot fluid later to produce steam or hot water that is used to produce electricity or for some other purpose. This heat storage technology is used with many solar thermal systems. A range of fluids have been used in solar systems, including oils and molten nitrate salts. There are two physical configurations: two-tank and thermocline systems. In a two-tank system, one tank holds cold fluid and one holds hot fluid, with the ratio of fill levels in the tanks indicating the state of charge. In a thermocline system, hot fluid is injected at the top of the tank, and cold fluid is injected at the bottom. In both cases, one heat exchanger is used to heat the fluid during charging and one is used to cool the fluid to produce steam during discharging. The use of two heat exchangers allows the rate of steam input into storage to be sized separately from the rate of heat output based on market

economics. In markets where electricity prices go near zero, the input heat rates may be much higher than the output rates. In solar thermal systems two-tank sensible heat storage has been demonstrated at the 100 MWh scale, and the thermocline type has been demonstrated at the 1 MWh scale.

Two separate studies have examined coupling sensible heat storage to LWRs. The North Carolina State and Westinghouse designs enable peak power capabilities 20 to 25% higher than base-load power. Both studies concluded heat transfer oils are likely to be the preferred heat transfer fluid when coupling sensible heat storage to an LWR.

The North Carolina State University studies [Frick, June 2017; Frick, October 2017] examined the use of oil heat transfer fluids for heat storage coupled to small modular pressurized water reactors for variable electricity production. The system can be scaled to any size. The analysis simulated reactor operations where the reactor operated at constant output with variable electricity to the grid. The flow sheet is shown in Fig. D.5. Organic heat transfer fluids have been used in the chemical industry since the 1920s and since the 1980s in solar thermal power systems. In this case the chosen fluid is Therminol[®]-66 that has an operational range of -2.7 to 343.3°C, a boiling point of 358°C and a heat capacity of 1.039 kWh/(m³·°C). The Nevada Solar One heat storage system uses Dowtherm[®] A, a similar heat transfer fluid, for heat storage [Kuravi, 2013].

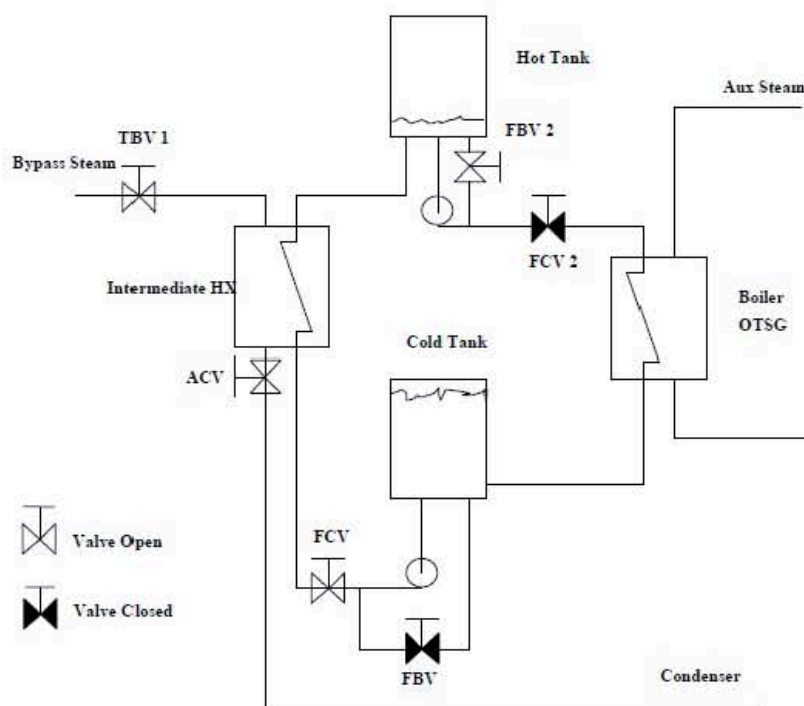

Fig. D.5. Nuclear Thermal Energy Storage System (Charging Mode)

Westinghouse [Westinghouse 2016; Forsberg, July 2017] has begun development of a sensible heat storage system for LWRs (Fig. D.6) where each storage module stores sufficient heat to generate 1 MWh of electricity. Steam heats the low-pressure oil that then transfers its heat to a heat storage module. The storage tanks have vertical concrete plates as the primary heat storage media rather than oil because concrete is much less expensive than oil as a heat storage media and the concrete plates can be manufactured locally. The hot oil flows through narrow channels between slabs of concrete. To recover the heat, the direction of oil flow is reversed. The hot oil can be used to generate steam that is sent to (1) the main reactor turbine, (2) a partial replacement for steam to feed-water heaters, or (3) a separate power system.

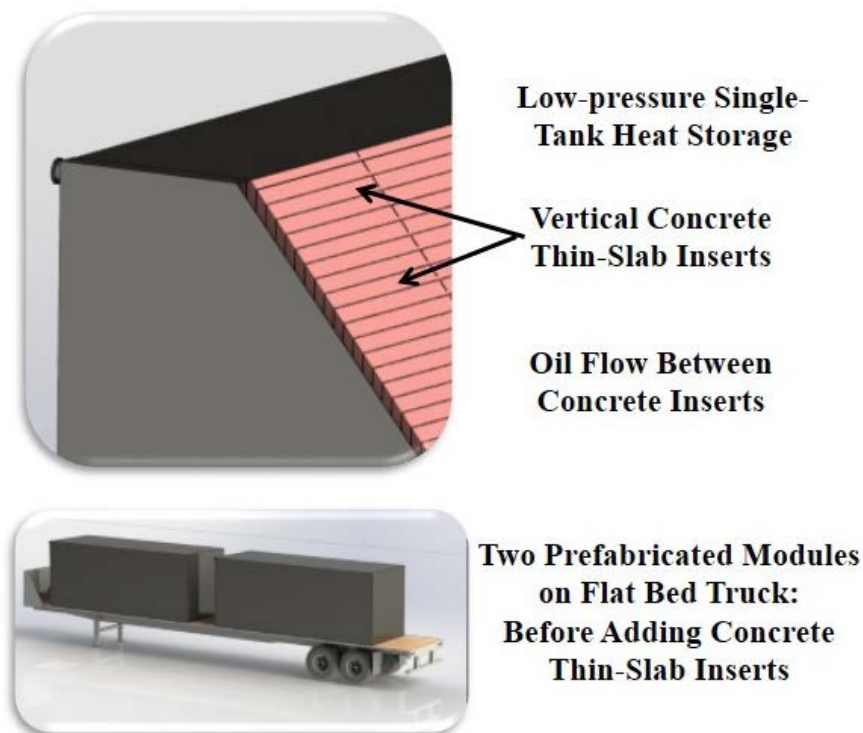

Fig. D.6. Westinghouse Thermal Heat Storage Module for 1 MWh of Electricity Storage

For existing nuclear plants the heat storage capacity would be up to 1-GWh with a heat input rate equivalent to 200 MWe and an output rate of 100 MWe. The round trip efficiency would be about 60% with options for significantly improved efficiency. Options are more limited for existing plants than for new plants. In a new plant the peak power output would be 20 to 25% greater than the base-load capacity using the main turbine for the peak power output to minimize capital costs and enable fast response. There would be a slight loss in base-load plant efficiency (~1%) for this peaking capability.

D.2.3. Cryogenic Liquid Air Storage

A cryogenic air energy storage system [Chen, 2007; Li, 2014; Ding, 2016; Highview, 2017; Forsberg, June 2017] stores energy by liquefying air (Fig. D.7). A less tightly coupled cryogenic system would use electric motors to drive the chilling process; the option exists to more tightly integrate the chilling process with the nuclear plant and provide steam for steam turbines in the air liquefaction plant. This is a common chemical industry practice because of the lower cost of steam turbines compared to large motors. During the liquefaction process, the compression heat can be stored for reuse in the power recovery (discharge) process, whereas waste cold during the discharge process can be stored for later use in the liquefaction process to reduce power consumption. The liquefied air can be stored in facilities similar to those used to store liquefied natural gas (LNG). The energy storage capacity of the liquid air reservoir and round-trip efficiency can be enhanced through the integration of a sensible/latent heat and cold storage system.

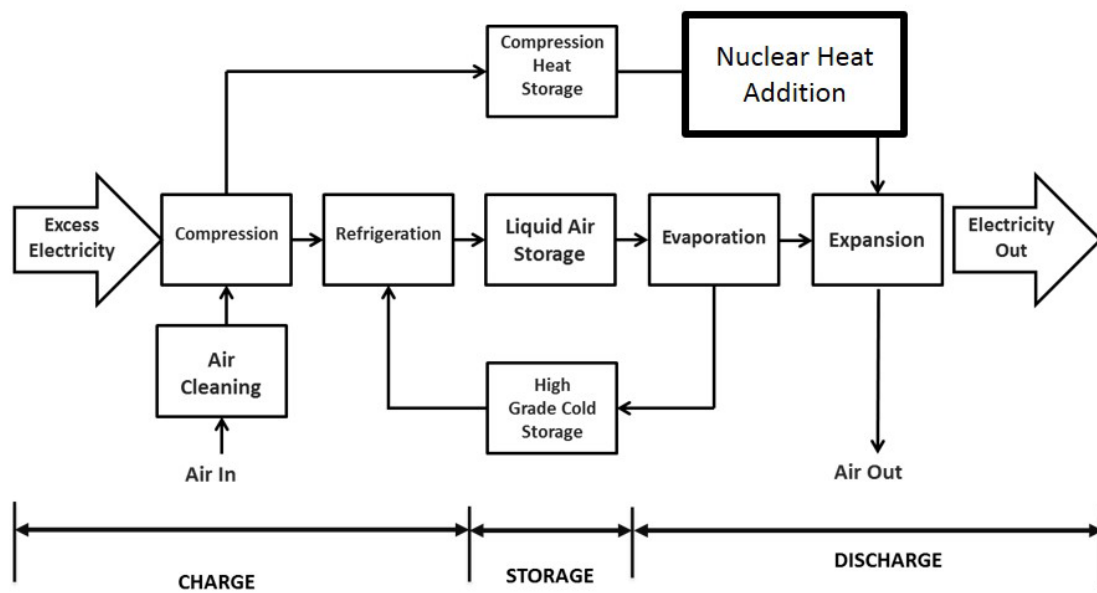

Fig. D.7. A schematic diagram of the cryogenic energy storage technology [Ding, 2016]

To produce electricity, the liquid air is compressed to high pressures, converted to a high-pressure gas using ambient heat and available waste heat, including that from the nuclear power plant tertiary side (warm cooling water), further heated in a heat exchanger using steam from the nuclear power plant secondary side, and sent through a gas turbine before being exhausted to the atmosphere. During this power recovery process, cold energy can be recovered through heat exchange for use in the liquefaction process as mentioned above.

If only warm cooling water from the nuclear plant or other low-temperature heat source is used, the estimated round-trip efficiency of a stand-alone system is around 60% [Ding, 2016]. With an integrated cryogenic-nuclear power plant system (steam to heat compressed air) the round-trip efficiency can be between 70 and 75% [Ding, 2013; Li, 2014] with a peak power up to 2.7 times the base-load power plant capacity. The reason for the high efficiency and power output is that the LWR steam is adding heat to boost the efficiency of a liquid-air cycle and is a thermodynamic topping cycle. Normally, one does not consider LWR steam to be high-temperature heat, but in a power cycle where the bottom temperature is the temperature of liquid air (-194°C ; 79°K), 270°C steam is hot.

A small pilot plant (350 kW/2.5 MWh) is in operation and a commercial non-nuclear demonstration plant (5 MW/15MWh), shown in Figure D.8, is due to be operational in July 2017, both in the United Kingdom.



Fig. D.8. Highview 5MW/15MWh Commercial Demonstration plant in Manchester Integrated with Viridor Biogas Power Plant

This storage technology is applicable to any reactor type. What changes is the entry temperature of the air into the gas turbine—a simple change because modern gas turbines operate at temperatures far above any reactor coolant temperature.

D.2.4. Pressurized Counter-Current Condensing-Steam Solid Heat Storage

A packed-bed thermal energy storage system [Bindra, 2013; Edwards, 2016a, Edwards, 2016b] consists of a pressure vessel filled with solid pebbles with a steam valve at the top and water outlet at

the bottom. Heat is stored as sensible heat in the pebbles. At the end of a discharge cycle, the pebble bed is filled with cold water. To charge the system (Fig. D.9), steam is injected at the top of the vessel as water is drained from the bottom of the vessel. The steam condenses as the cold pebbles are heated. Because of the extremely good heat transfer of condensing steam, the steam condensation occurs in a small band, resulting in hot pebbles above the condensation zone and cold pebbles below the condensation zone. At the end of the charging cycle all pebbles are hot and are in a steam environment.

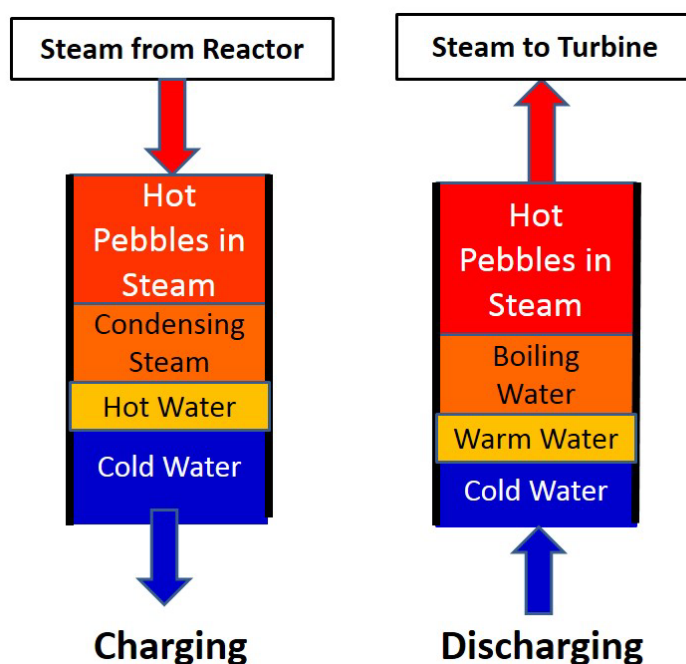

Fig. D.9. Operation of Pressurized Counter-Current Heat Storage

During the discharge cycle water is added at the bottom of the vessel. The hot water is converted into steam by the hot pebbles and sent to a turbine to produce electricity. Because boiling is highly efficient, heat transfer occurs in a small zone from bottom to top with the steam leaving the vessel as hot steam as it flows through the remainder of the hot packed bed.

In theory this should be the most efficient heat storage system in terms of round-trip efficiency. The heat storage system directly uses steam with no temperature losses in a heat exchanger in either direction—steam in and steam out. Packed beds are more thermodynamically efficient than other storage systems because they operate in a counter-current mode—the hottest steam sees the hottest pebbles. A sharp hot-to-cold front with small dimensions is only possible with a saturated-steam input, where the very high heat transfer of condensation and boiling occurs over a very small zone in the bed.

This is not true for superheated steam and other systems where the length of the heat transfer zone becomes excessively long relative to the dimensions of practical systems. There has been limited experimental work. Figure D.10 shows some recent experiments with a packed column and the sharp line of condensation.

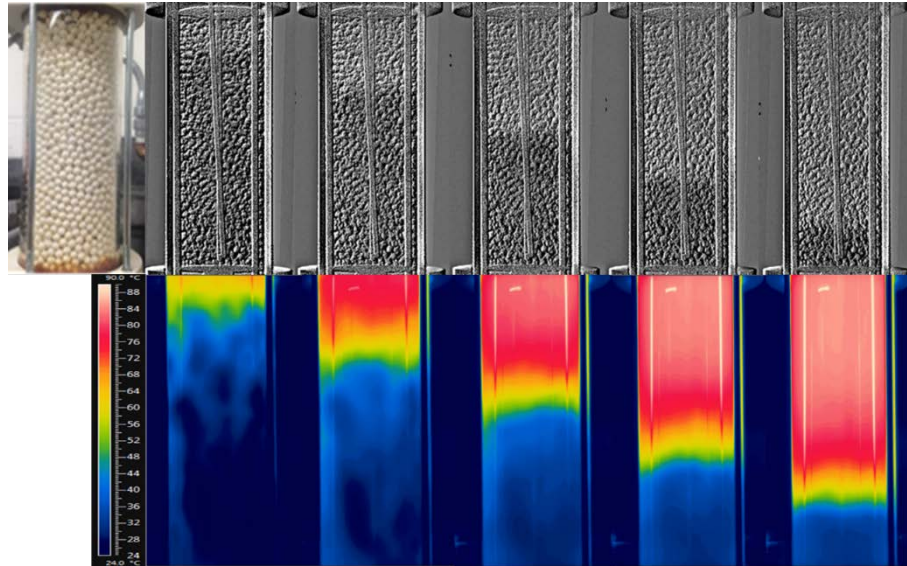

Fig. D.10. Atmospheric Steam as Heat Transfer Fluid and an Alumina Packed Bed as Storage Media, X-ray and IR Images Every 10 Seconds [Bindra 2017]

The design options for packed-bed systems, including the range of suitable pebble materials and sizes, and the impacts of pebble choice on dynamic performance, are only partly explored. The storage economics is likely limited to hourly and daily cycles because of the cost of the pressure vessel. This storage technology is applicable to water cooled reactors with steam cycles but would not be applicable to higher-temperature reactors with very high-temperature steam cycles. The higher storage system performance is dependent upon steam condensation and boiling in a small zone.

D.2.5. Atmospheric-Pressure Crushed-Rock Heat Storage

A hot rock energy storage system [Forsberg, April 2017] is similar in concept to a packed bed energy storage system except that it operates at atmospheric pressure. A volume of crushed rock with air ducts at the top and bottom is created (Fig. D.11). To charge the system, air is heated using a steam-

to-air heat exchanger delivering heat from the reactor, then the hot air is circulated through the crushed rock, heating the rock. To discharge the system, the airflow is reversed, and cold air is circulated through the crushed rock. The discharged hot air can be used to (1) produce steam for electricity or industry or (2) hot air for collocated industrial furnaces to reduce natural gas consumption.

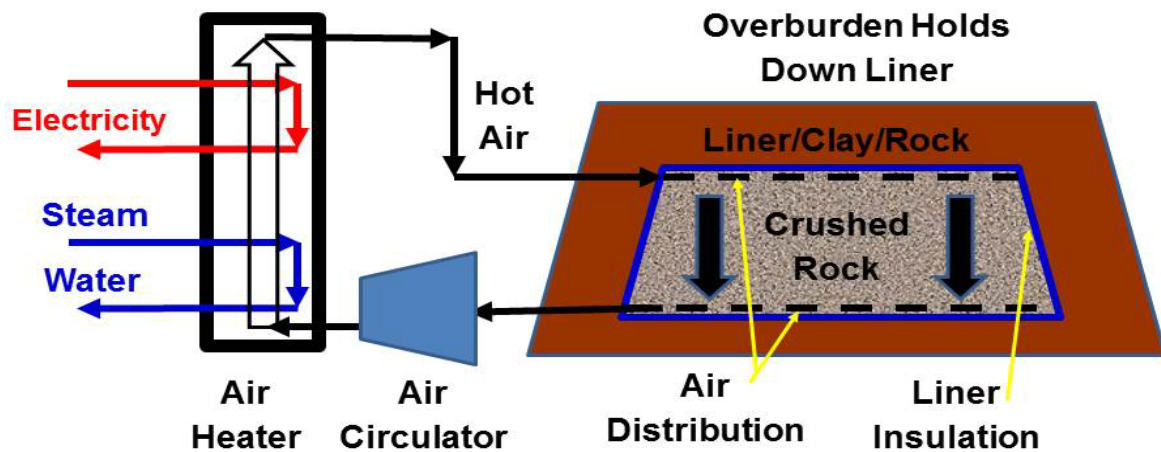

Fig. D.11. Hot Rock Storage with Steam and Electric Input

Heat storage systems are only charged at times of very low electricity prices. There is the option with this system to first heat the air with a steam-air heat exchanger and then further heat the air with electric resistance heating. LWR steam peak temperatures are near 300°C—well below the temperature limits of the crushed rock. Higher temperatures improve system efficiency and reduce costs. This can substantially boost rock temperatures, and the efficiency of converting hot air back to electricity, and reduce capital costs. Near-atmospheric operating conditions increase safety and reduce storage costs.

There is ongoing work [Forsberg, July 2017b] on heating firebrick or rock to high temperatures at times of low electricity prices using electric resistance heating. Air would be blown through the hot rock to provide hot air to industrial furnaces and steam plants.

A variant of large hot-rock systems is under development by the shale oil industry (Red Leaf Inc.) to produce oil. In that system the rock is crushed oil shale and heated hot gases are circulated through the rock to decompose solid kerogen into liquid and gaseous hydrocarbon fuels. For that system the rock pile will be about 30 meters high. Much of the technology required for hot rock heat storage is being developed by such projects.

Only limited studies have been done of this option. The economics may allow hourly, daily, and weekly storage. The longer storage times may be possible due to the very low incremental heat storage cost for crushed rock—far lower than any of the previous options that have been discussed. As such, this technology can address the weekday-weekend storage challenge where energy demand goes down on weekends but the production of wind, solar and nuclear does not if these facilities are operated at their full capacity. It is a storage technology that could potentially receive capacity payments for assured generation of electricity. With proper selection of rock for the expected peak temperatures, this storage system should be able to couple to most other reactors. The possible exception may be very high temperature reactors where finding suitable rock for such high temperatures may be difficult.

D.2.6. Nuclear Geothermal Heat Storage

Heat Storage

Geologic heat storage systems [Lee, 2010; Lee, 2011; Forsberg, 2012; Forsberg, 2013] combine the features of an enhanced geothermal energy facility with thermal energy storage. Thermal energy is stored (Fig. D.12) underground by injecting hot water heated by the reactor from the surface into the rock reservoir; heat is primarily stored in the rock, and heat is recovered by water flowing through the rock back to the surface for electricity production in a conventional geothermal plant. Under certain circumstances, there may be the option to use carbon dioxide [Kulhanek, 2012] as the heat transfer fluid. This is the only heat storage option that is a candidate for hourly through seasonal energy storage because of the extremely low cost of the storage media—hot rock.

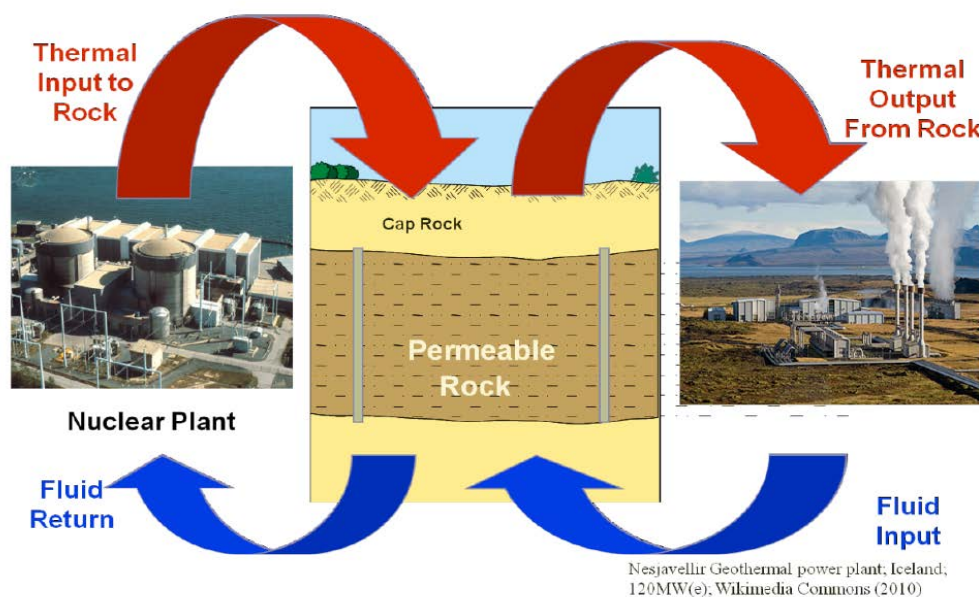

Fig. D.12. Nuclear Geothermal Heat Storage

It is not possible to insulate rock 500 to 1000 meters underground. There is always the slow loss of heat by conduction into surrounding rock. However, heat losses are proportional to the surface area of the storage zone while heat storage capacity is proportional to the volume. Heat losses vary by the square of the storage reservoir size while heat storage varies by the cube of the storage reservoir size; thus, heat losses decrease as the system size increases (Fig. D.13). The minimum heat storage is a tenth of a gigawatt year—30 to 40 GWd of heat if heat losses are to be limited to a few percent of the heat being stored. As a consequence, this system would be designed for hourly to at least weekly (weekday/weekend) storage. The minimum required scale matches nuclear plants or very large solar thermal systems.

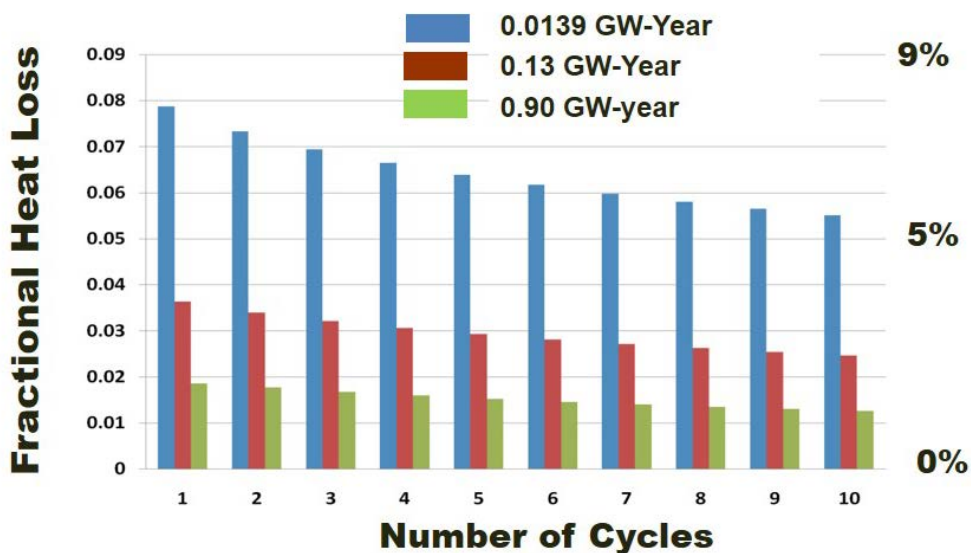

Fig. D.13. Fractional Energy Losses vs. Cycle for Three Reservoir Sizes

Geothermal heat storage would couple to LWRs but not reactors with higher-temperature steam cycles. As water temperatures increase in rock, different elements in the rock dissolve into the water or precipitate from the water. The practical implications are that LWRs are near the peak allowable temperatures for water-based geothermal systems—higher temperatures create conditions where rock dissolution and precipitation may block pores and channels required for efficient hot water flow through the rock.

Geothermal power plants have historically had relatively low efficiencies [Moon, 2012]. A nuclear geothermal power plant has two differences relative to traditional geothermal power plants that may improve efficiency and reduce costs. First, the power output will be hundreds of megawatts versus tens of megawatts with gains in efficiency associated with larger equipment and more optimized equipment. This includes three-stage and possible four-stage flash power plants that are more efficient than two-stage flash systems but require more equipment. Second, the reservoir will have much cleaner hot water than a typical geothermal power plant. In most geothermal plants the hot water or steam contains large quantities of carbon dioxide and other gases that lower steam cycle efficiency—including the need to remove large quantities of non-condensable gases from the condenser. In a nuclear geothermal system these gases and other impurities are “washed out” of the rock in the first few cycles of operation because the same rock is used again and again.

Heat can be added in two ways. The first option is to pump cold water from the underground geology, send it through a heat exchanger, and then inject it into the hot storage zone. There is a second option now being explored where steam is sent through a jet pump to heat the water and replace the conventional pumps. This option eliminates the temperature drops and costs associated with the heat exchanger, resulting in higher round-trip efficiencies. It avoids the issues associated with fouling the heat exchanger with geothermal water. It would provide a low-cost method to send large quantities of heat into the storage reservoir. However, it comes with the added cost of needing large quantities of clean makeup water for the reactor steam generator. Nuclear geothermal heat storage is dependent upon appropriate geology. Unlike other storage systems, it can't be built at all locations.

Earth Battery

Recent work on advanced underground energy storage systems [Buscheck, 2014; 2015; 2016; 2017] have combined underground heat storage, compressed gas storage (CO₂, N₂, or air), and potentially carbon dioxide sequestration (Fig. D.14). These are enabled by advances in the ability to characterize underground rock formations and advanced drilling techniques [King, 2012]. Controlling hydrostatic pressures can create high pressure “walls” to minimize the migration of hot water and compressed gas from the system. This enables the storage of compressed gases—a second form of geological energy storage. This implies that the energy input at times of low electricity prices may be (1) heat from reactors to create hot-water storage volume (and to heat rock) and (2) electricity from the grid to create a compressed gas storage volume. The compressed gas can be used directly as an energy storage system or to pressurize the system so that there is no need to pump hot water for heat recovery when the

geothermal plant is operating. The waste heat of gas compression can also be stored together with heat diverted from the LWR. In principal, this approach could take all of the diverted thermal energy and remaining generated electricity from an LWR nuclear power plant during periods of over-generation.

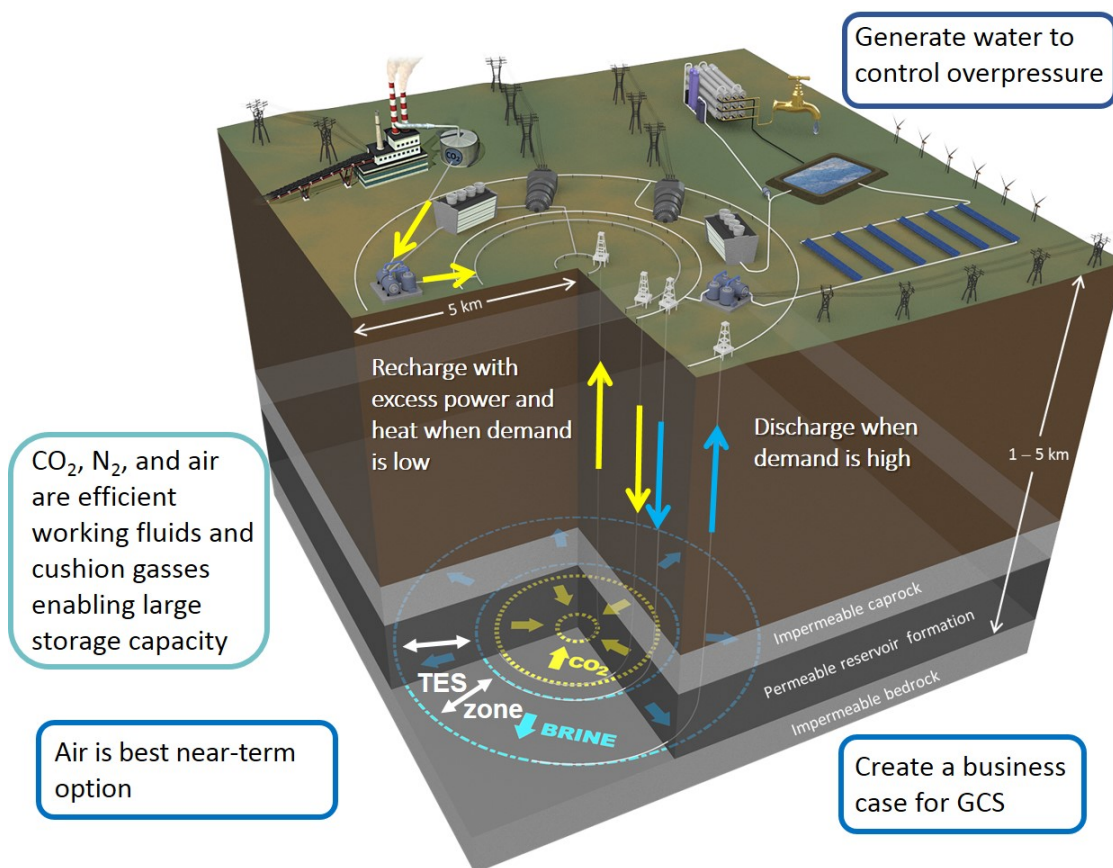

Fig. D.14. An Earth Battery System with CO₂ is Shown

Unique Characteristics

The unique feature of nuclear geothermal energy storage is the ability to enable seasonal and multiyear energy storage—and with that capability, assured generating capacity. The incremental cost of added heat storage capacity in many geologies is near zero. The primary cost of seasonal or multiyear storage is the cost of the heat. This characteristic creates the option of a strategic heat storage reserve—similar to strategic oil and natural gas storage reserves to guard against disruptions in fossil-fuel supply. In a low-carbon world those disruptions could be of biofuels (weather), hydrogen if imported, unexpected weather events such as multiyear droughts that limit hydroelectric output, and major

weather events such as large hurricanes that result in large scale damage to wind production capacity. This also implies that such a storage system could obtain capacity payments because of the assured ability to generate electricity on demand. It is the only storage system that has equivalent assured capacity to a nuclear reactor or fossil fuel plant.

D.3. Choice of Heat Storage Technology

D.3.1. Technology Characteristics of Different Storage Systems

Different electricity markets have different constraints and requirements. On the production side, large-scale solar will depress prices at times of high solar input—a daily cycle. Large-scale wind is often on a multi-day cycle with coupled daily variations that impact production and thus prices. Electricity demand has a daily cycle, a weekly cycle (weekday and weekend), and a seasonal cycle. Each reactor thermal storage technology has its own characteristics (Table D.2)—rate of charging and associated costs (\$/MWt), round-trip efficiency, cost of storage (\$/MWh), rate of discharge and cost of associated energy conversion (\$/MWe). The preferred storage technology will depend on the cost of the technology and on the specific market.

Table D.2. Relative Storage Option Characteristics

Property	Accumulator	Latent Heat	Counter-Current	Cryogenic	Hot Rock	Geo-Thermal
Storage Time						
Hours	Yes	Yes	Yes	Yes	Yes	Yes
Weekly	?	?	?	?	Yes	Yes
Seasonal	No	No	No	No	No	Yes
Heat Input Method/Rate	Direct Steam/Fast	Heat Exchanger (HX)/Medium	Direct Steam/Fast	HX Medium	HX Medium	Direct Steam/Fast or HX
Output versus Input	Variable	Variable	Variable	High	Low	Low
Deployment Status	Near Term	Near Term	Mid Term	Mid Term	Mid Term	Longer Term
Capital Cost: Heat input	Very Low	Medium	Very low	High	Medium	Low or Medium
Capital Cost: Incremental Heat Storage	High (High Pressure)	Medium	High (High Pressure)	Medium	Very Low	Very Low

Capital Cost: Heat-to-Electric Output	Low to Medium	Low to Medium	Low to Medium	Low (Gas Turbine)	Low to Medium	Medium to High
Round Trip Efficiency	Medium	Medium	High	Medium	Medium	Low

The cost of heat input into a storage system depends on whether steam is the input or heat is transferred through a heat exchanger to a secondary fluid. Because of the cost of heat exchangers, storage systems with the option of direct steam input (accumulators, geothermal, etc.) will have an advantage in markets where the electricity price collapses to very low levels for limited periods of time—such as in some markets with solar price collapse. In those markets one wants to quickly charge the storage system while the price is low.

Several of the technologies (sensible heat, hot rock and geological) may be able to participate in capacity markets with assured capability to produce electricity when needed because of their low cost of incremental heat storage (\$/MWh). The ability of the other technologies to participate in electricity capacity markets will depend upon how capacity markets are defined—the length of time that electricity must be delivered. This is in contrast to almost all other storage technologies (batteries, most but not all pumped hydro) where the incremental energy storage costs are too large for this to be viable.

Several heat storage technologies could be deployed in the next several years because the technology exists and has been deployed in other energy markets and deployment is primarily dependent upon engineering and projected economics in specific markets. This includes steam accumulators and sensible heat storage. Other storage technologies require significant research and development before large-scale deployment.

D.3.2. Operational Strategies: Differences between Heat Storage and Electricity Storage

The cost structure of most nuclear heat storage technologies are different than electricity storage technologies. Heat storage capital costs can be broken into three major components:

- *Input capital costs (\$/kW)*. This is the cost of steam into the energy storage system and measured in dollars per kW. For a steam accumulator or counter-current pebble bed system, the cost is that of valves and piping. For other systems it is the cost of a heat exchanger.
- *Storage capital costs (\$/kWh)*. This cost is proportional to energy stored. It is higher for steam accumulators where there is a pressure vessel but very low for technologies such as hot rock storage.
- *Heat-to-Electricity capital costs (\$/kWe)*. This is a significant cost. There are large incentives to use the nuclear plant turbine generator where possible because the incremental cost for

additional generating capacity is much lower than a stand-alone power generation system.

The implications of this cost structure is that it is cheap to put heat into heat storage but more expensive to convert that heat back to electricity. The likely implications are shown in Fig. D.15 for a California market where solar at certain times of year collapses the price of electricity. A heat storage system will divert as much heat to storage when the price is low—seven hours per day in this example. The heat will be converted back to electricity over 17 hours at a constant rate. This minimizes the capital costs of the expensive heat-to-electricity component of the storage system.

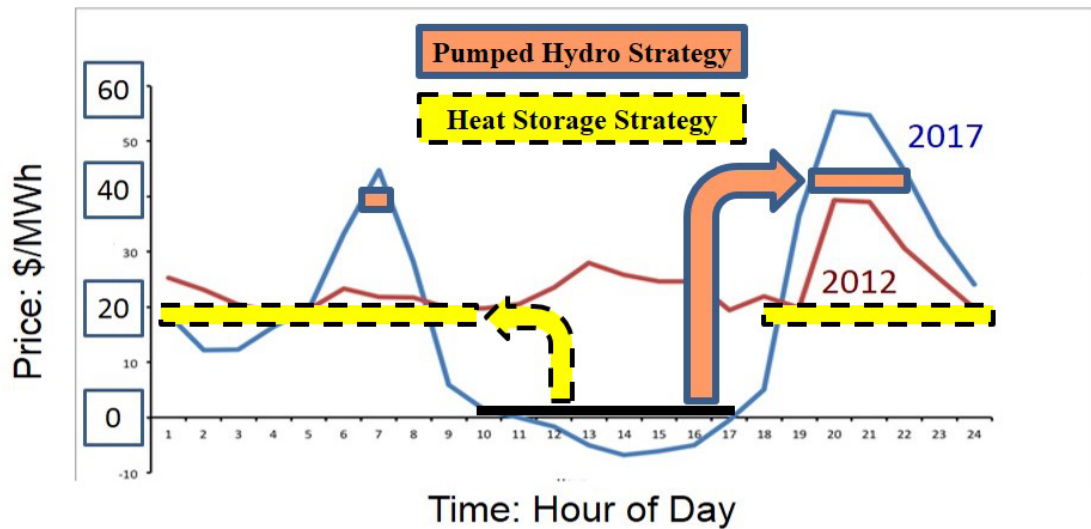

Fig. D.15. Alternative Buy and Sell Strategies for Batteries (Sell Limited Hours) and Nuclear Heat Storage (Sell Many Hours) in California Electricity Market, Spring Day Shown

A pumped hydro facility will be operated in a different mode. In a pumped hydro facility there are two major capital costs.

- Electricity input / output capital costs (\$/kWe). In most pumped hydro systems, the pump-motor to move water up the hill is operated in reverse as the turbine-generator to produce electricity. Input rates equal output rates.
- Storage capital costs (\$/kWh). The storage costs are associated with building the upper and lower water storage facilities.

With this cost structure, pumped hydro will buy and sell electricity for equal amounts of time choosing to buy when prices are lowest and sell when prices are highest. In this example this might be for 7 hours each way each day.

For existing nuclear plants this operational strategy is beneficial. In a market with large-scale solar and existing nuclear plants the profitable strategy may be to send steam to storage 7 hours per day when prices are low and produce added electricity 17 hours per day. In effect, the system would have very

high steam rates (20 to 25% of plant output) into storage (low-cost part of system) and smaller peak electricity production rates (higher-cost part of system). This strategy would minimize changes in the existing plant and in most cases little or no upgrading of the turbine-generator to produce added electricity when prices are higher. What can be done is plant specific. When viewing such a nuclear plant as a black box, the addition of storage would appear to have increased its “base-load” capacity by less than 5% with the capability to ramp down power output at times of low electricity prices. Inside the plant the reactor is operating at full capacity at all times. This capability is separate and independent of the ability of the reactor to lower its power output.

With new LWRs, there are wider choices. Limited studies suggest that with a new plant, the plant would divert up to 70% of its steam to storage at times of low electricity prices with peak output 125% of base-load capacity. The reactor would operate at all times at full load. The maximum diversion of steam to storage is partly determined by (1) the need to have the turbine running to be able to rapidly go back to full power and (2) lower efficiencies at operating at very low power capacity. Peak power limits are partly controlled by loss of efficiency if the turbine is greatly oversized.

D.4. REFERENCES

Bindra, H., et al., 2013. “Thermal Analysis and Exergy Evaluation of Packed Bed Thermal Storage Systems.” *Applied Thermal Engineering*, **52**, 255-263.

Bindra, H., J. Edwards, D. Gould, 2017. *Methods and Systems for Thermal Energy Storage and Recovery*, U.S. Patent Application No. 62/339,576 (International Patent Application No. PCT/US2017/033566)

Birnbaum, J., M. Eck, M. Fichtner, T. Hirsch, D. Lehmann and G. Zimmermann, 2010, “A Direct Steam Generation Solar Power Plant With Integrated Thermal Storage,” *Journal of Solar Energy Engineering*, **132** (3), p. 31014.

Bisett, S., A. LaPortin and E. Schneider, June 11-15, 2017, “Steam Accumulator Storage Integration into a Nuclear Power Plant,” *Transactions of the American Nuclear Society*, San Francisco.

Buscheck, T. A., et al., 2014, “Integrating CO₂ Storage with Geothermal Resources for Dispatchable Renewable Electricity”, *Energy Procedia*, **63**, 7619-7630.

Buscheck, T. A., December 2015, “Earth Battery,” *Mechanical Engineering*, **137**,
https://www.google.com/?gws_rd=ssl#q=Earth+Battery+ASME+Mechanical+Engineering+Magazine.

Buscheck, T.A., J. M. Bielicki, T. A. Edmunds, Y. Hao, Y. Sun, J. M. Randolph, and M. O. Saar, 2016. “Multifluid Geo-energy Systems: Using Geologic CO₂ Storage for Geothermal Energy

Production and Grid-scale Energy Storage in Sedimentary Basins”, *Geosphere*, **12** (3), doi:10.1130/GES01207.1.

Buscheck, T.A., J. M. Bielicki, J. B. Randolph, J.B., 2017. CO₂ Earth Storage: Enhanced Geothermal Energy and Water Recovery and Energy Storage, *Energy Procedia*.

Chen, H., Y. L. Ding, T. Peters, and F. Berger, 2007, *A method of storing energy and a cryogenic energy storage system*, WO 2007/096656

Ding, Y. L. Y. Li, Y. Jin, D. Li, G. Leng, F. Ye, Z. Sun, H. Cao, and G. Qiao, 2013, *A Peak-shaving Method for Nuclear Power Plants Through Integration with Cryogenic Energy Storage.*, CN201310279616.2.

Ding, Y.L. Y. Li, and J. Radcliffe, 2016, “Liquid Air Energy Storage.” *Storing Energy*, Trevor Letcher eds., Elsevier BV, ISBN 9780128034408.

Edwards, J. H., D. Franken, H. Bindra, and P. Sabharwall, November 6-10, 2016a, “Packed Bed Thermal Storage for Compact Light-Water Cooled Small Modular Reactors”, *Transactions of the American Nuclear Society Meeting*, **115**, Las Vegas, NV

Edwards, J., H. Bindra, and P. Sabharwall, 2016b, “Exergy Analysis of Thermal Energy Storage Options with Nuclear Power Plants,” *Annals of Nuclear Energy*, **96**, 104-111.

Fitzhugh, R. L., J. D. Richards, J. M. Schaumann, and M. J. Memmott, April 17-20, 2016, “Preliminary Design of a Thermal Energy Storage System for a Light Water reactor,” *International Congress on Advanced Nuclear Power Plants (ICAPP 2016)*, San Francisco.

Frick, K., J. M. Doster and S. M. Bragg-Sitton, June 11-15, 2017, “Control Strategies for Coupling Thermal Energy Storage Systems with Small Modular Reactors”, *Trans. American Nuclear Society*, San Francisco.

Frick, K., J. M. Doster and S. M. Bragg-Sitton, October 29-November 27, 2017, “Design of a Sensible Heat Peaking Unit for Small Modular Reactors”, *Trans. American Nuclear Society*, Washington D.C.

Forsberg, C., June 24-28, 2012, “Gigawatt-Year Nuclear-Geothermal Energy Storage for Light-Water and High-Temperature Reactors, *Proc. of International Congress on Advanced Nuclear Power Plants (ICAPP’2012)*.

Forsberg, C., 2013, “Hybrid Systems to Address Seasonal Mismatches Between Electricity Production and Demand in Nuclear Renewable Electricity Grids,” *Energy Policy*, **62**, 333-341.

Forsberg, C., D. Curtis, and D. Stack, April 2017 “Light-water Reactors with Crushed-Rock Thermal Storage for Industrial Heat and High-Value Electricity,” *Nuclear Technology*, **198**, <http://dx.doi.org/10.1080/00295450.2017.1294426>

Forsberg, C. W., et al. July 2017a, *Light Water Reactor Heat Storage for Peak Power and Increased Revenue: Focused Workshop on Near-Term Options*, MIT-ANP-TR-170, Massachusetts Institute of Technology, Cambridge, Massachusetts.

Forsberg, C., D. C. Stack, D. Curtis, G. Haratyk and N. A. Sepulveda, July 2017b. “Converting Excess Low-Priced Electricity into High-Temperature Stored Heat For Industry and High-Value Electricity Production,” *Electricity Journal*.

Gilli, P. V. and K. Fritz, October 5-9, 1970, “Nuclear Power Plants with Integrated Steam Accumulators for Load Peaking” IAEA Symposium on Economic Integration of Nuclear Power Stations in Electric Power Systems, Vienna, WB-KE-2015.

Gilli, P. V. and G. Beckman, August, 1973, “Steam Storage Adds Peaking Electricity Capacity to Nuclear Plants,” *Energy International*.

Han, W.; J. Hongguang, S. Jianfeng; L. Rumou; and W. Zhifeng, Oct. 2009. “Design of the First Chinese 1 MW Solar-Power Tower Demonstration Plant.” *Int. J. Green Energy*, **6** (5), pp. 414–425.

Highview Power Storage, 2017, *Liquid Air Energy Storage (LAES)*. <http://www.highview-power.com/>

Hirsch, T., J. Feldhoff, K. Hennecke & R. Pitz-Paal, 2014, “Advancements in the Field of Direct Steam Generation in Linear Solar Concentrators—A Review,” *Heat Transfer Engineering*, **35** (3), pp. 258–271.

Harvey, A. L., July, 2017, “The Latest in Thermal Energy Storage”, *Power*, **161** (7), 50-52.

International Atomic Energy Agency, 2017, *Opportunities for Cogeneration with Nuclear Energy*, NP-T-4.1, Vienna, Austria.

G. E. King, 2012, *Hydraulic Fracturing 101: What Every Representative, Environmentalist, Regulator, Reporter, Investor, University Researcher, Neighbor and Engineer Should Know About Estimating Frac Risks and Improving Rack Performance in Unconventional Gas and Oil Wells*, SPE 152596, Society of Petroleum Engineers.

Kulhanek, M., C. W. Forsberg, and M. J. Driscoll, January 2012. *Nuclear Geothermal Heat Storage: Choosing the Geothermal Heat Transfer Fluid*, MIT-NES-TR-016, Massachusetts Institute of Technology, Cambridge, Massachusetts.

- Kuravi, S. et al, 2013, “Thermal Energy Storage Technologies and Systems for Concentrating Solar Power Plants (Review),” *Progress in Energy and Combustion Science*, **39**, 285-319
- Laing, D., C. Bahl, T. Bauer, D. Lehmann & W. Steinmann, 2011, “Thermal energy storage for direct steam generation,” *Solar Energy*, **85** (4), pp. 627–633.
- Lane, R. E. III, *Modeling and Integration of Steam Accumulators in Nuclear Steam Supply Systems*, MS Thesis, University of Texas at Austin, December 2016.
- LaPotin, A. and E. Schneider, November 2016, “An Economic Model of a Steam Accumulator Storage System for Nuclear Power Plants”, *Transactions of the American Nuclear Society*.
- Lee, Y., C. Forsberg, M. Driscoll, and B. Sapie, June 13-17, 2010. “Options for Nuclear Geothermal Gigawatt-Year Peak Electricity Storage Systems, *Proc. of ICAPP’10*, San Diego.
- Lee, Y., June 2011. *Conceptual Design of Nuclear-Geothermal Energy Storage Systems for Variable Electricity Production*, MS Thesis, Department of Nuclear Science and Engineering, Massachusetts Institute of Technology.
- Li, Y., H. Cao, S. Wang, D. Li, X. Wang, and Y. Ding, 2014, “Load shifting of nuclear power plants using cryogenic energy storage technology.” *Applied Energy*, **113** p. 1710–1716.
- Mann, W. N. 2017. *Construction of Hybrid Nuclear Thermal Energy Storage Systems under Electric Market Uncertainty*, MS Thesis, University of Texas at Austin
- Medrano, M., A. Gil, I. Martorell, X. Potau & L. F. Cabeza, 2010, “State of the art on high-temperature thermal energy storage for power generation. Part 2—Case studies,” *Renewable and Sustainable Energy Reviews*, **14** (1), pp. 56–72.
- Moon, H and S. J. Zarrouk, November 19-21, 2012. “Efficiency of Geothermal Power Plants: a Worldwide Review,” *Proc. New Zealand Geothermal Workshop*, Auckland, New Zealand.
- National Renewable Energy Laboratory, 2017. “Concentrating Solar Power Projects.” [Online]. Available: <https://www.nrel.gov/csp/solarpaces/index.cfm>
- Schmidt, O., A. Hawkes, A. Gambhir, and I Staffell, July 10, 2017. “The Future Cost of Electrical Energy Storage Based on Experience Rates,” *Nature Energy*, **2**, Article 17110
- Steinmann, W.D. and M. Eck, 2006, “Buffer storage for direct steam generation,” *Solar Energy*, **80** (10), pp. 1277–1282.
- Westinghouse Electric Company LLC, 2016, *Nuclear Energy Storage*.

Zunft, S., S. Freund, and E. M. Schlichtenmayer, November 19-21, 2014, “Large-Scale Electricity Storage with Adiabatic CAES – The Adele-Ing Project”, *Energy Storage Global Conference*, Paris.