

# Radiative Equilibrium

- Equilibrium state of atmosphere and surface in the absence of non-radiative enthalpy fluxes
- Radiative heating drives actual state toward state of radiative equilibrium

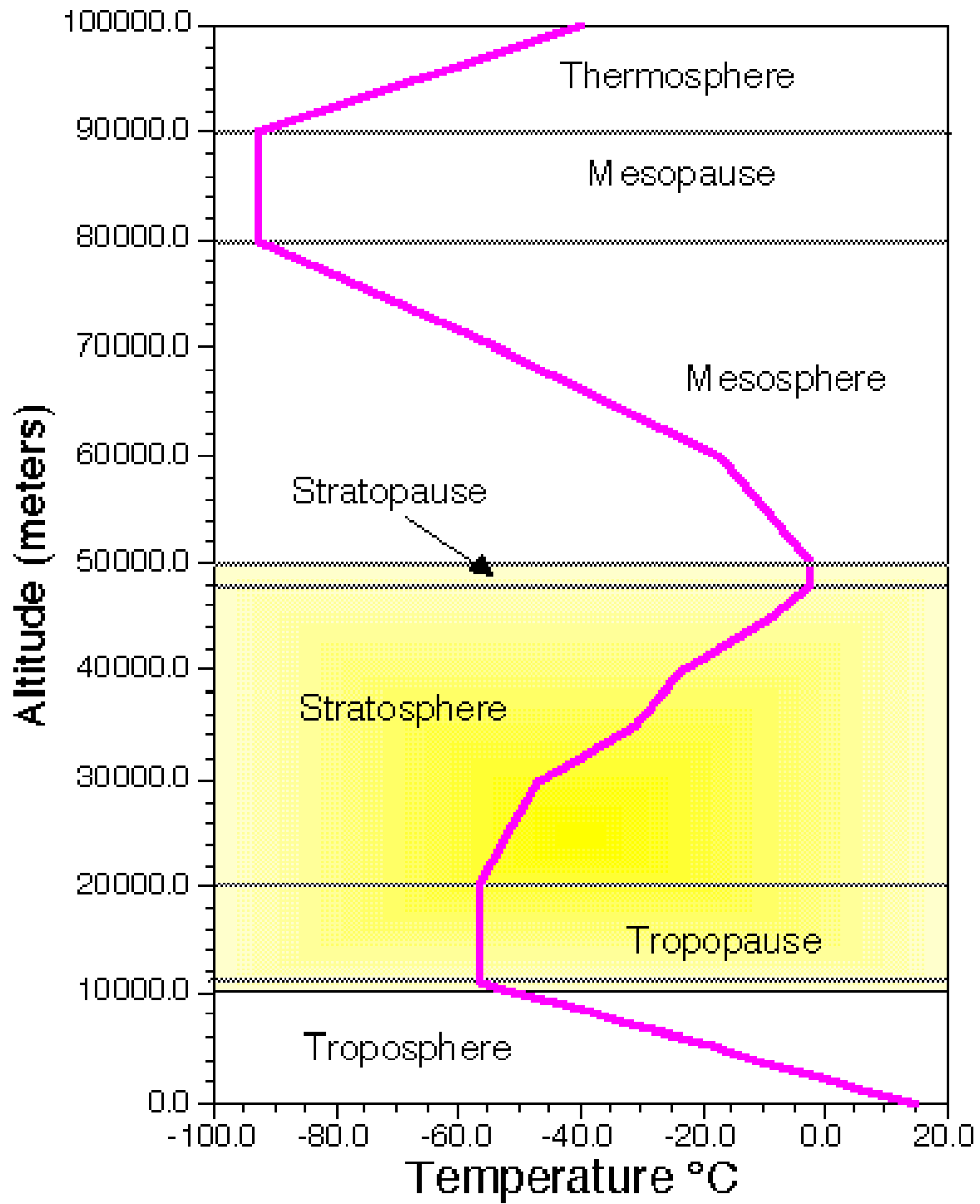

# Extended Layer Models

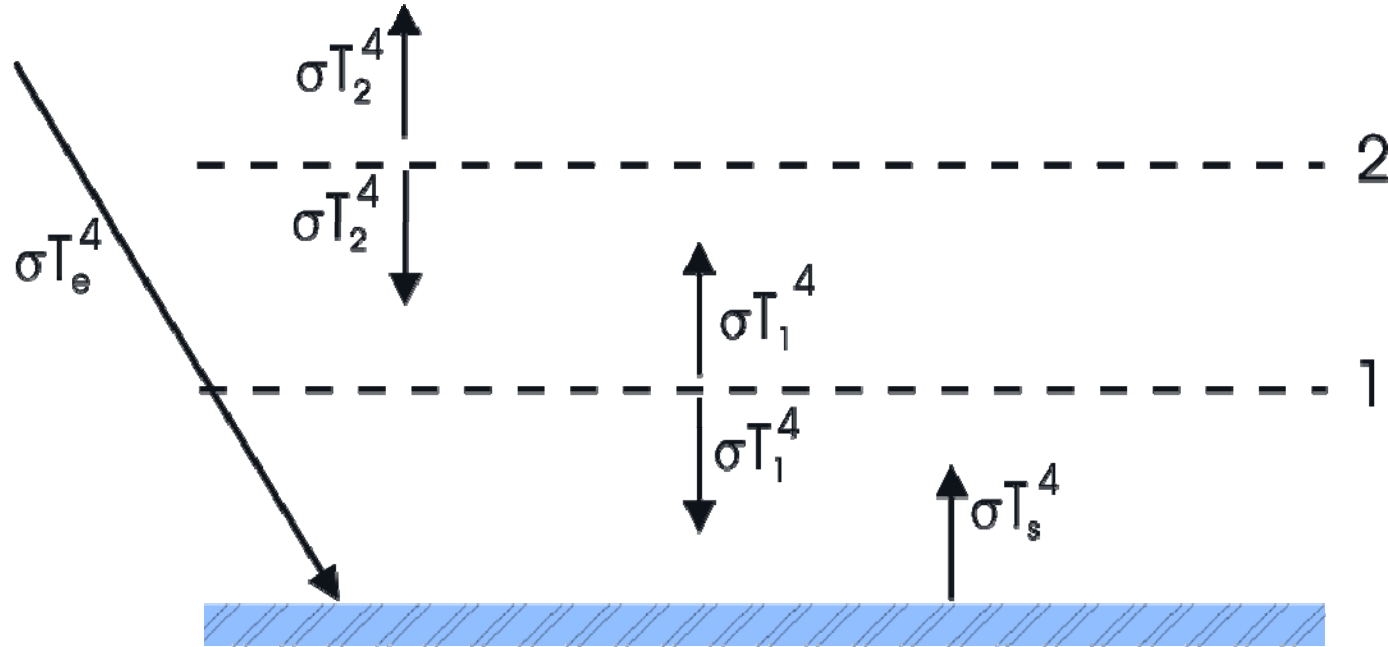

$$TOA: \quad \sigma T_2^4 = \sigma T_e^4 \rightarrow T_2 = T_e$$

$$Middle\ Layer: \quad 2\sigma T_1^4 = \sigma T_2^4 + \sigma T_s^4 = \sigma T_e^4 + \sigma T_s^4$$

$$Surface: \quad \sigma T_s^4 = \sigma T_e^4 + \sigma T_1^4$$

$$\rightarrow T_s = 3^{1/4} T_e \quad T_1 = 2^{1/4} T_e$$

# Effects of emissivity < 1

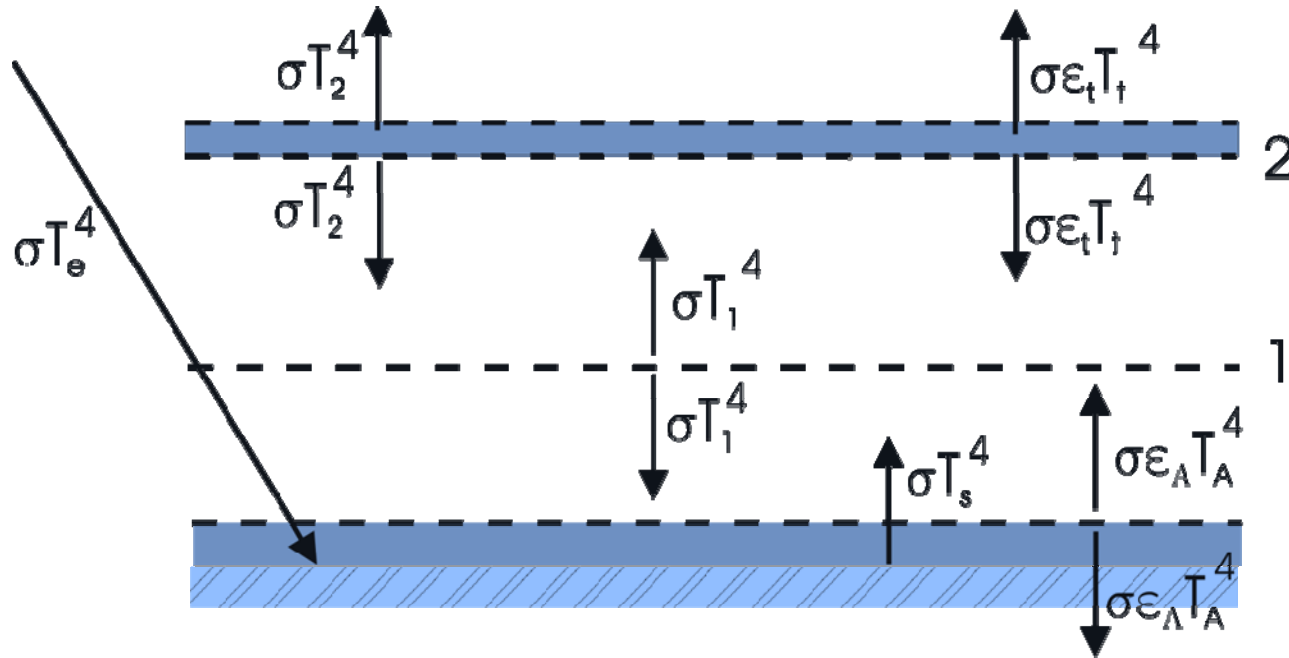

$$\text{Surface: } 2\epsilon_A \sigma T_A^4 = \epsilon_A \sigma T_1^4 + \epsilon_A \sigma T_s^4$$

$$\rightarrow T_A = \left(\frac{5}{2}\right)^{1/4} T_e \approx 321K < T_s$$

$$\text{Stratosphere: } 2\epsilon_t \sigma T_t^4 = \epsilon_t \sigma T_2^4$$

$$\rightarrow T_t = \left(\frac{1}{2}\right)^{1/4} T_e \approx 214K < T_e$$

## Full calculation of radiative equilibrium

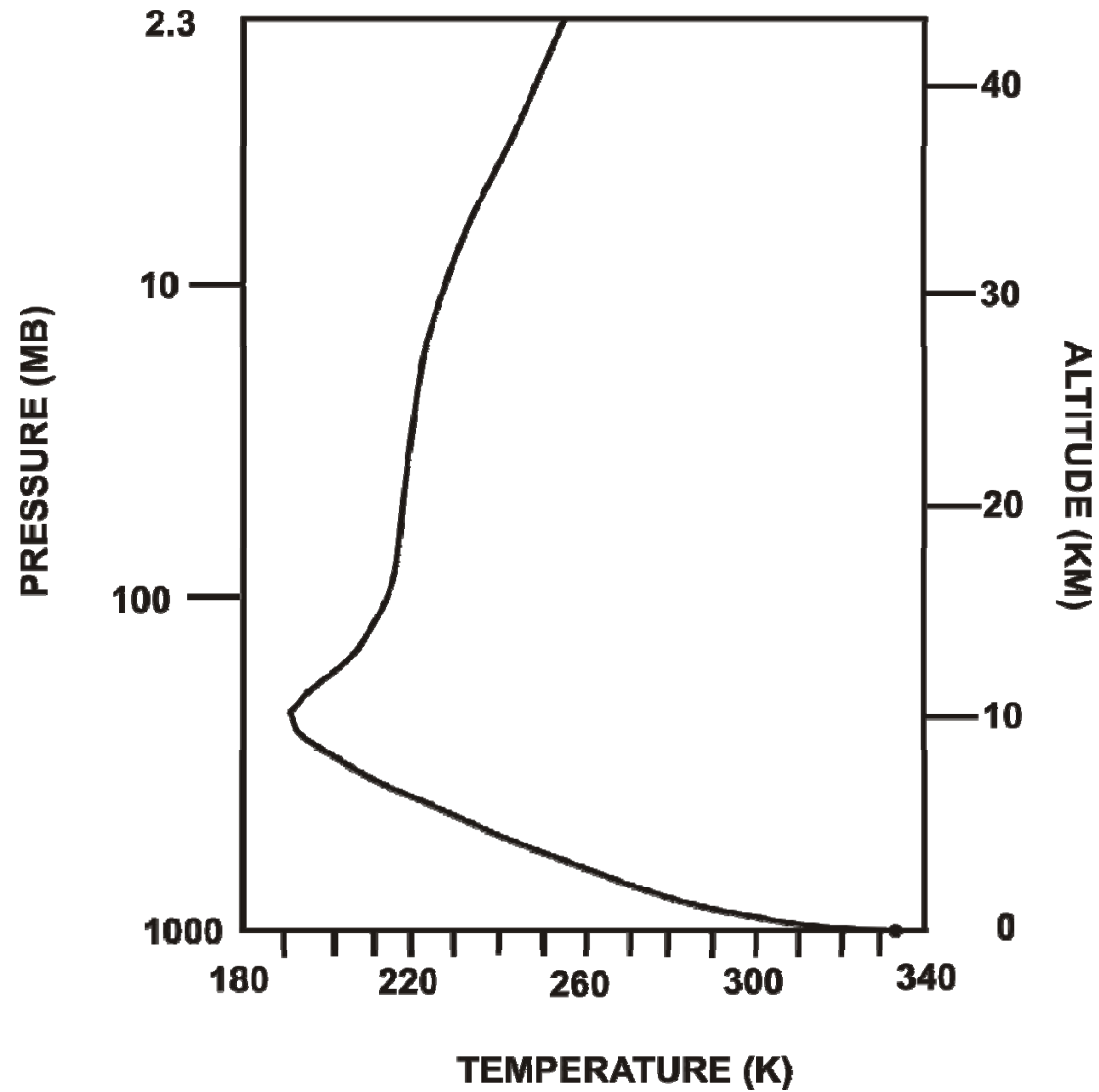

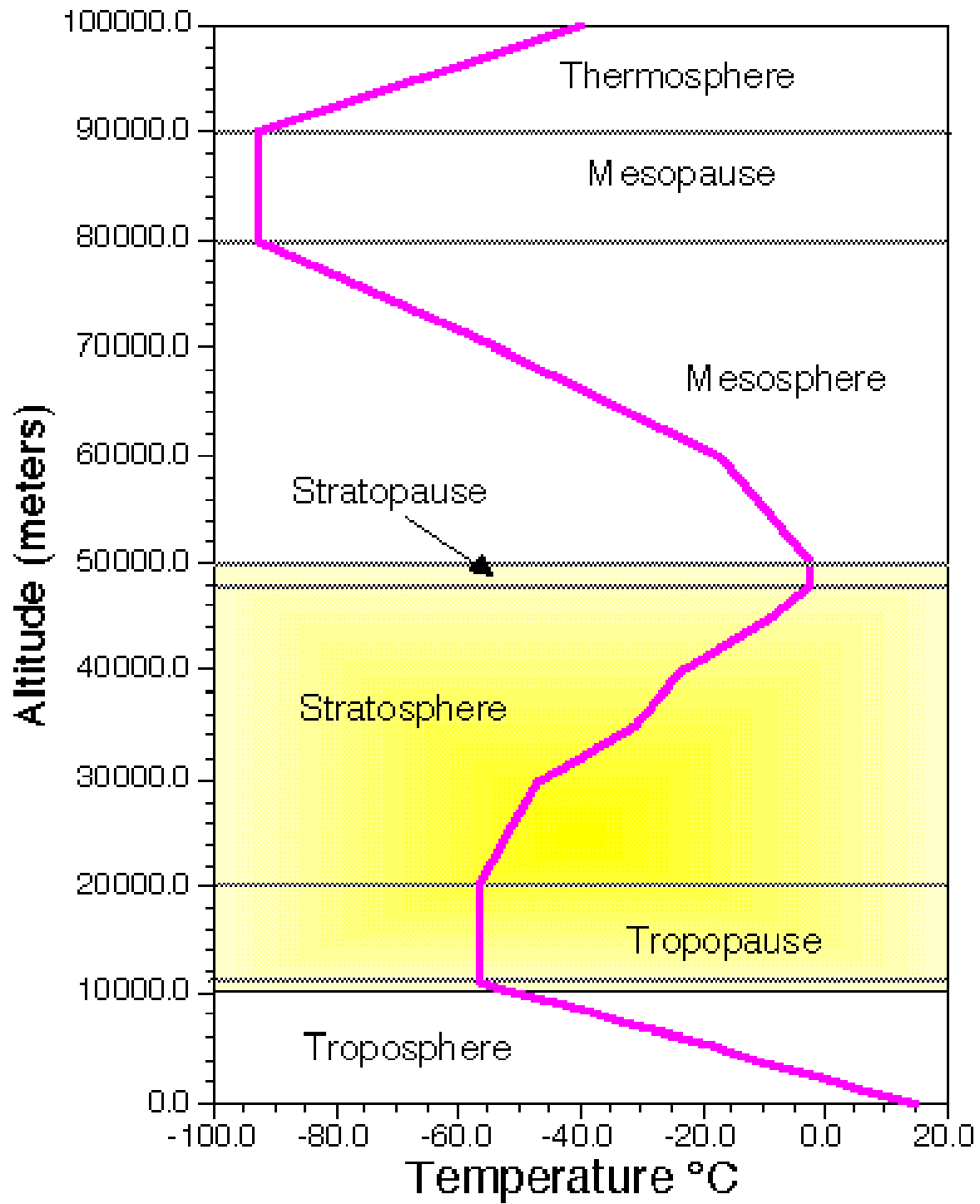

# Time scale of approach to equilibrium

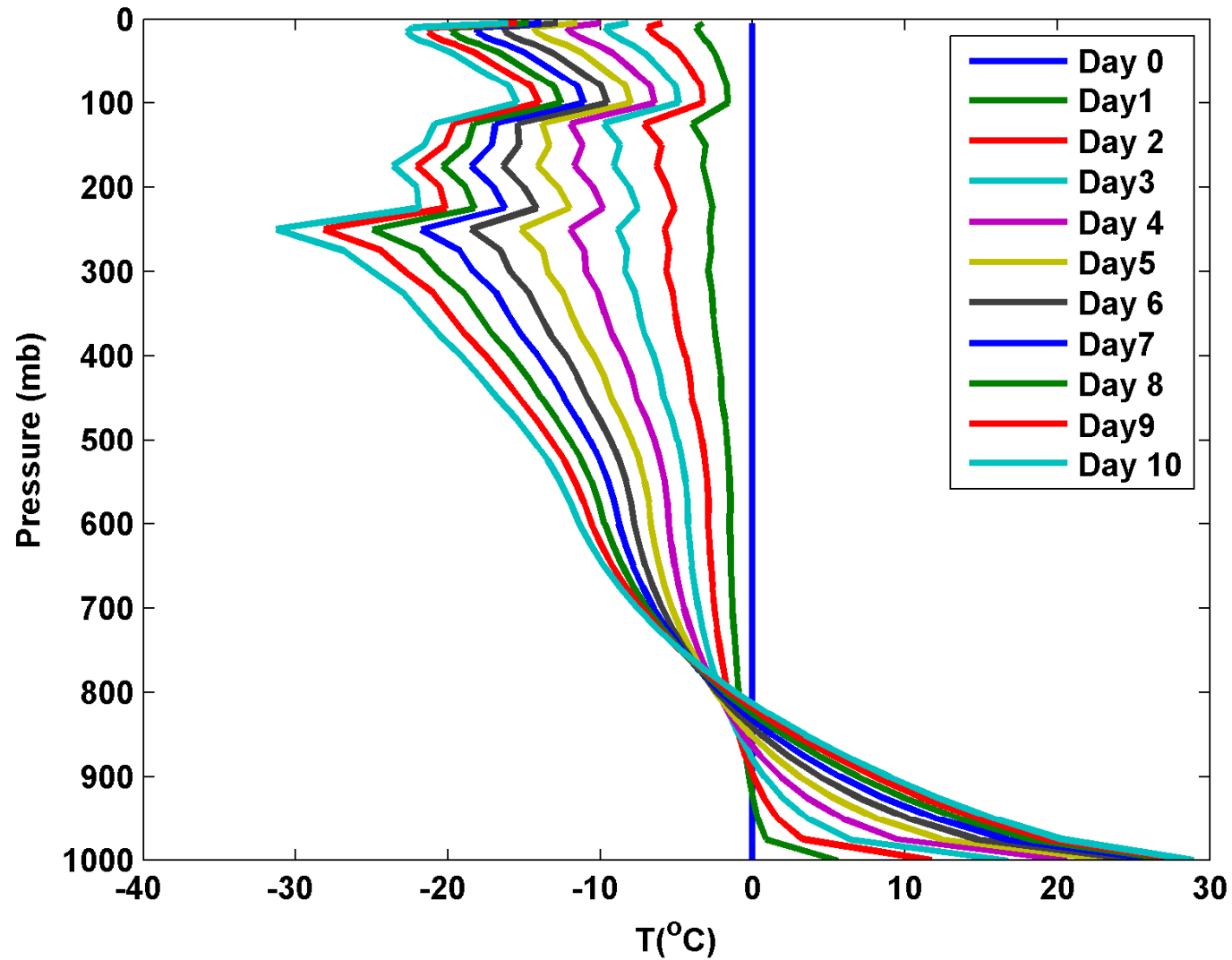

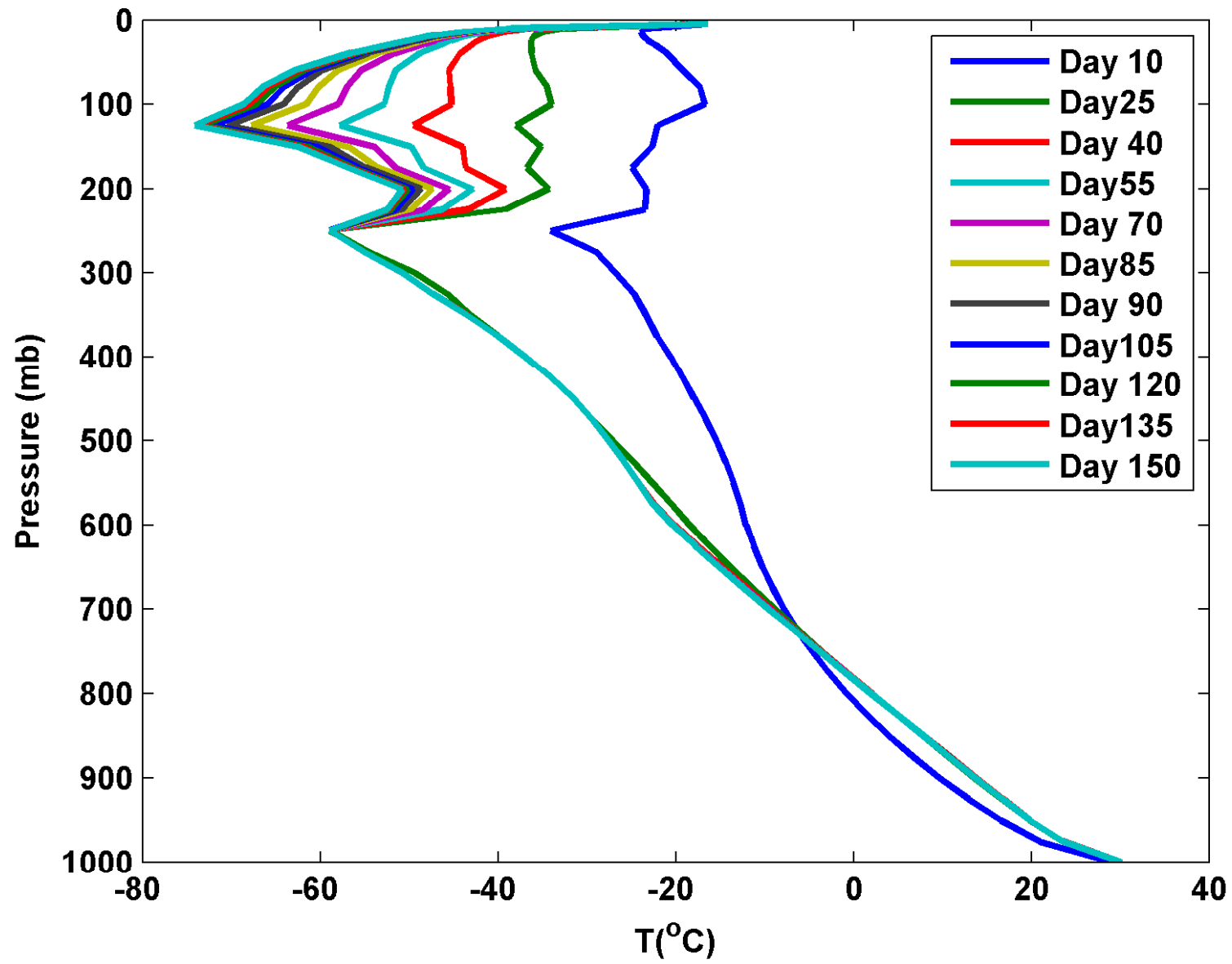



# Contributions of various absorbers

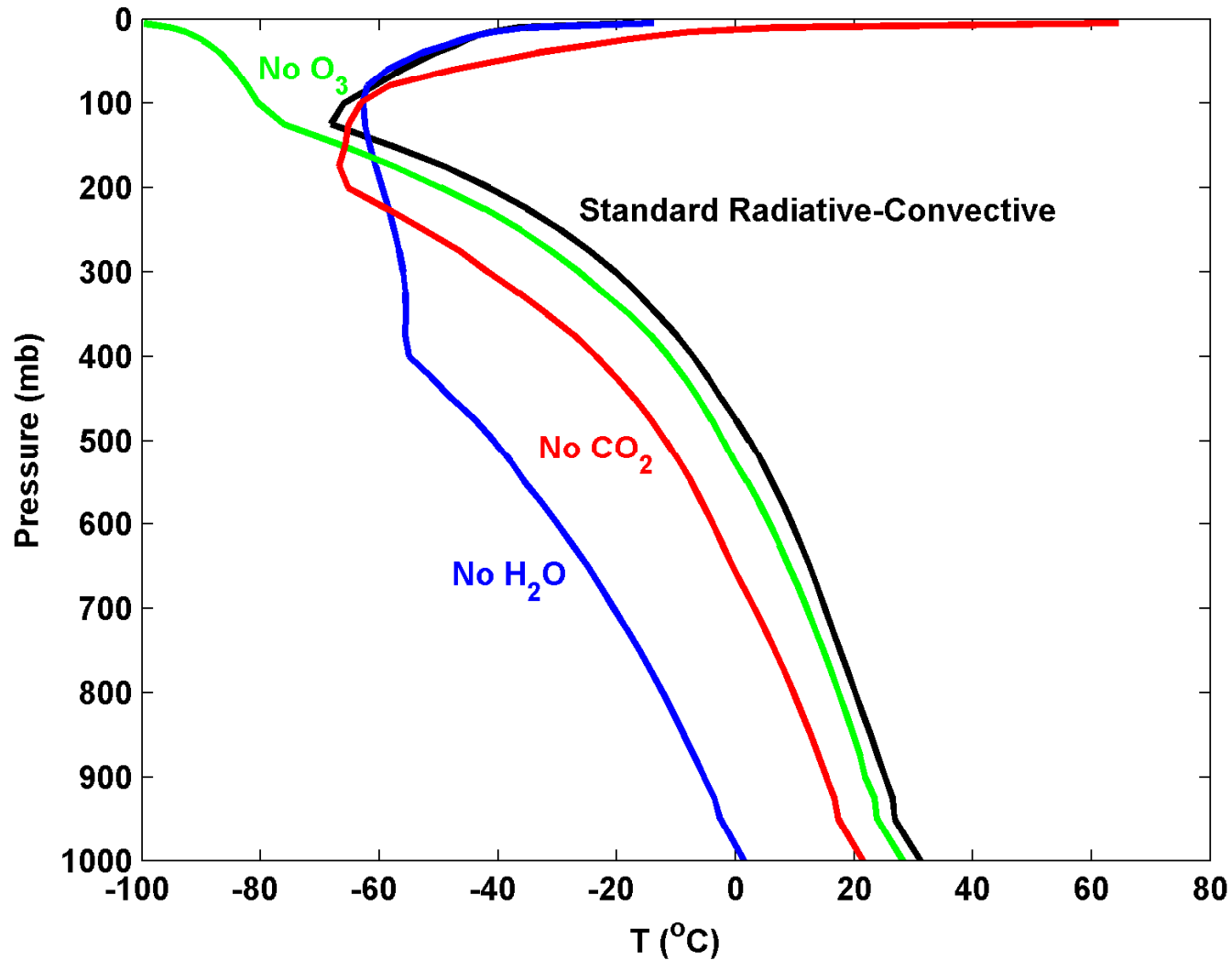

Note: All simulations have variable clouds interacting with radiation

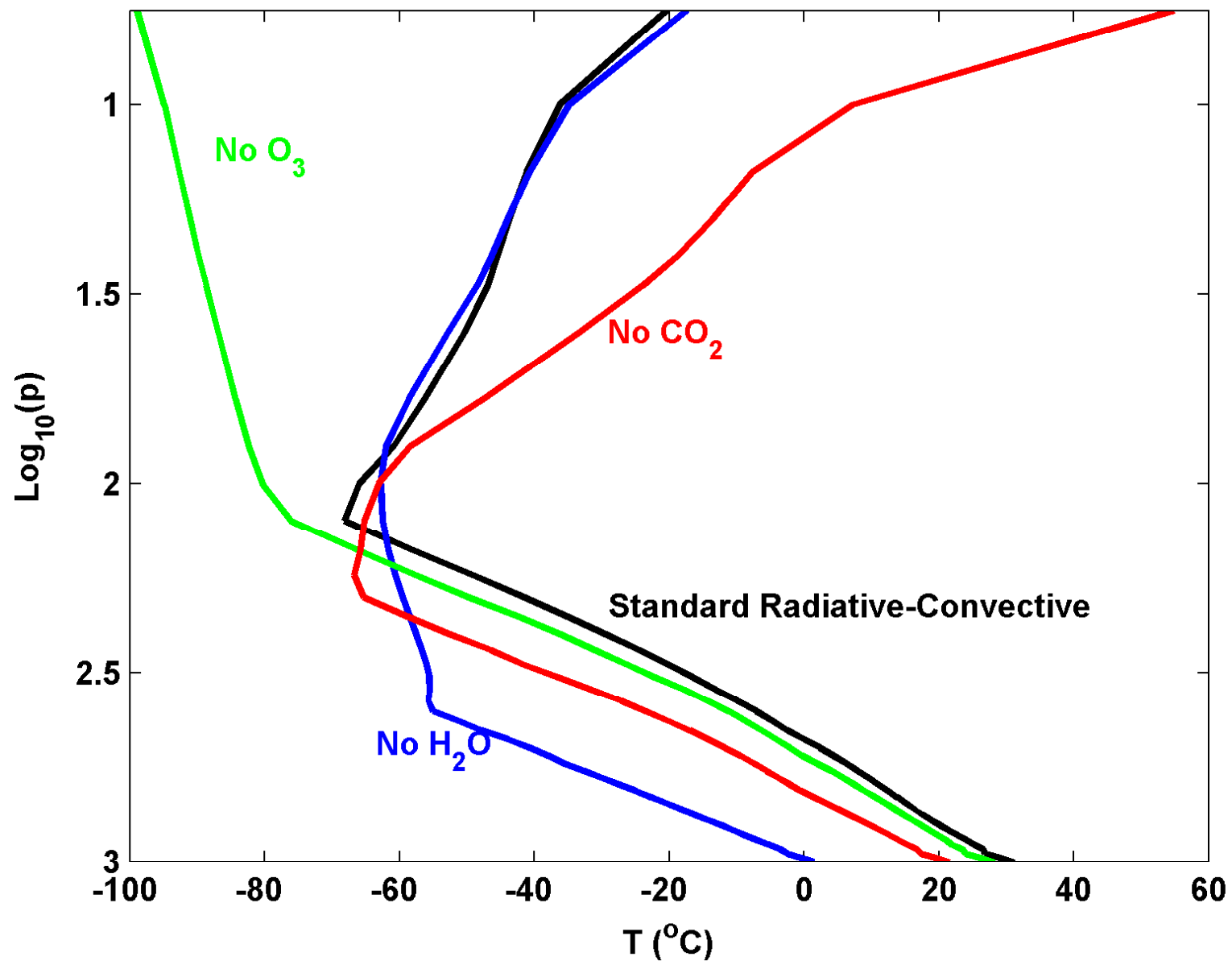

# Problems with radiative equilibrium solution

- Too hot at and near surface
- Too cold at a near tropopause
- Lapse rate of temperature too large in the troposphere
- (But stratosphere temperature close to observed)

# Missing ingredient: Convection

- As important as radiation in transporting enthalpy in the vertical
- Also controls distribution of water vapor and clouds, the two most important constituents in radiative transfer

# When is a fluid unstable to convection?

- Pressure and hydrostatic equilibrium
- Buoyancy
- Stability

# Hydrostatic equilibrium

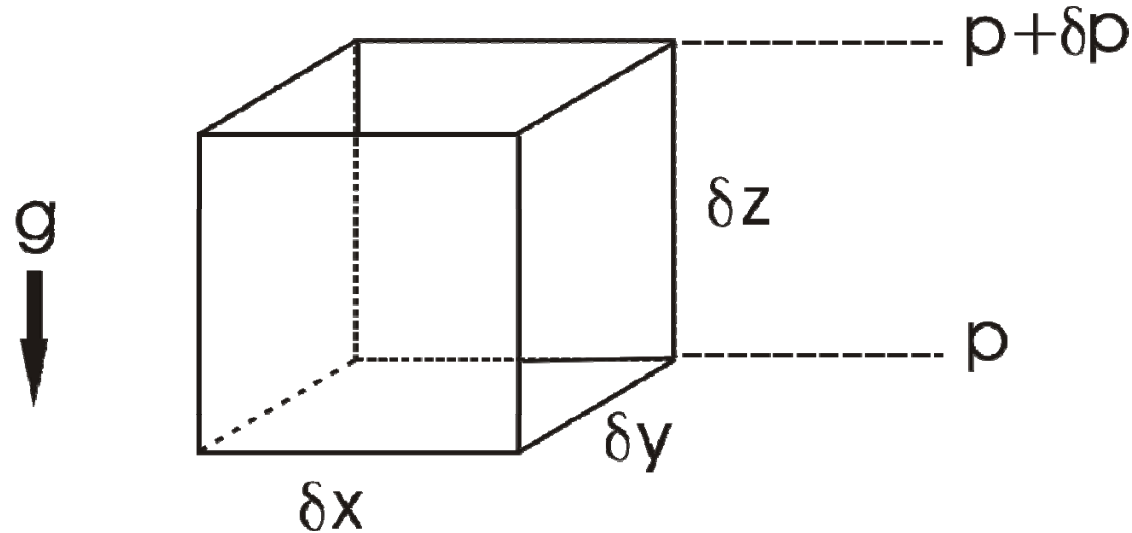

$$\text{Weight: } -g \rho \delta x \delta y \delta z$$

$$\text{Pressure: } p \delta x \delta y - (p + \delta p) \delta x \delta y$$

$$F = MA: \quad \rho \delta x \delta y \delta z \frac{dw}{dt} = -g \rho \delta x \delta y \delta z - \delta p \delta x \delta y$$

$$\frac{dw}{dt} = -g - \alpha \frac{\partial p}{\partial z}, \quad \alpha = \frac{1}{\rho} = \text{specific volume}$$

# Pressure distribution in atmosphere at rest

$$\text{Ideal gas: } \alpha = \frac{RT}{p}, \quad R \equiv \frac{R^*}{\bar{m}}$$

$$\text{Hydrostatic: } \frac{1}{p} \frac{\partial p}{\partial z} = -\frac{g}{RT}$$

$$\text{Isothermal case: } p = p_0 e^{-z/H}, \quad H \equiv \frac{RT}{g} = \text{"scale height"}$$

Earth:  $H \sim 8 \text{ Km}$

# Buoyancy

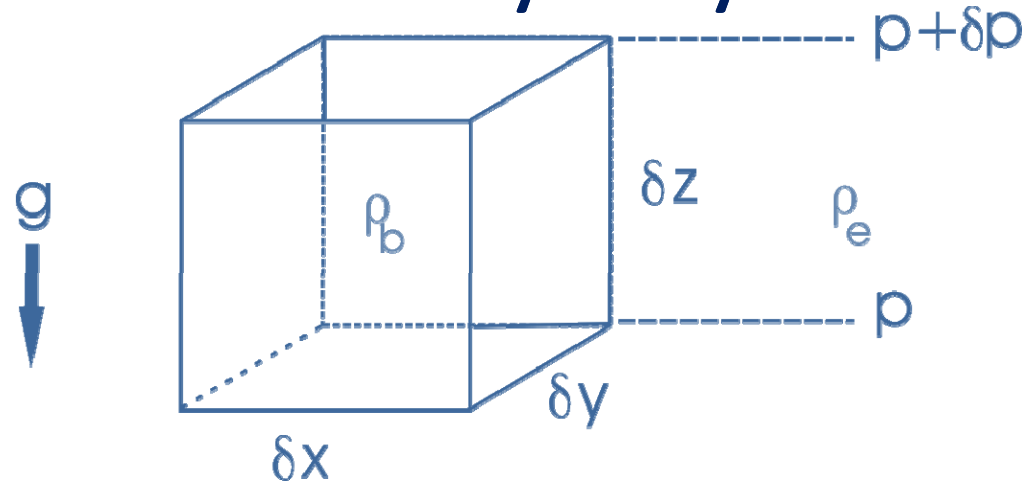

$$\text{Weight: } -g \rho_b \delta x \delta y \delta z$$

$$\text{Pressure: } p \delta x \delta y - (p + \delta p) \delta x \delta y$$

$$F = MA: \quad \rho_b \delta x \delta y \delta z \frac{dw}{dt} = -g \rho_b \delta x \delta y \delta z - \delta p \delta x \delta y$$

$$\frac{dw}{dt} = -g - \alpha_b \frac{\partial p}{\partial z} \quad \text{but} \quad \frac{\partial p}{\partial z} = -g / \alpha_e$$

$$\rightarrow \frac{dw}{dt} = g \frac{\alpha_b - \alpha_e}{\alpha_e} \equiv B$$



# Buoyancy and Entropy

Specific Volume:  $\alpha = 1/\rho$

Specific Entropy:  $s$

$$\alpha = \alpha(p, s)$$

$$(\delta\alpha)_p = \left(\frac{\partial\alpha}{\partial s}\right)_p \delta s = \left(\frac{\partial T}{\partial p}\right)_s \delta s$$

$$B = g \frac{(\delta\alpha)_p}{\alpha} = \frac{g}{\alpha} \left(\frac{\partial T}{\partial p}\right)_s \delta s = - \left(\frac{\partial T}{\partial z}\right)_s \delta s \equiv \Gamma \delta s$$

# The adiabatic lapse rate

*First Law of Thermodynamics :*

$$\begin{aligned}\dot{Q} &= T \frac{ds_{rev}}{dt} = c_v \frac{dT}{dt} + p \frac{d\alpha}{dt} \\ &= c_v \frac{dT}{dt} + \frac{d(\alpha p)}{dt} - \alpha \frac{dp}{dt} \\ &= (c_v + R) \frac{dT}{dt} - \alpha \frac{dp}{dt} \\ &= c_p \frac{dT}{dt} - \alpha \frac{dp}{dt}\end{aligned}$$

*Adiabatic :*  $c_p dT - \alpha dp = 0$

*Hydrostatic :*  $c_p dT + g dz = 0$

$$\rightarrow \left( \frac{dT}{dz} \right)_s = - \frac{g}{c_p} \equiv -\Gamma_d$$

$$\Gamma = g / c_p$$

Earth's atmosphere:

$$\Gamma = 1 K / 100 m$$

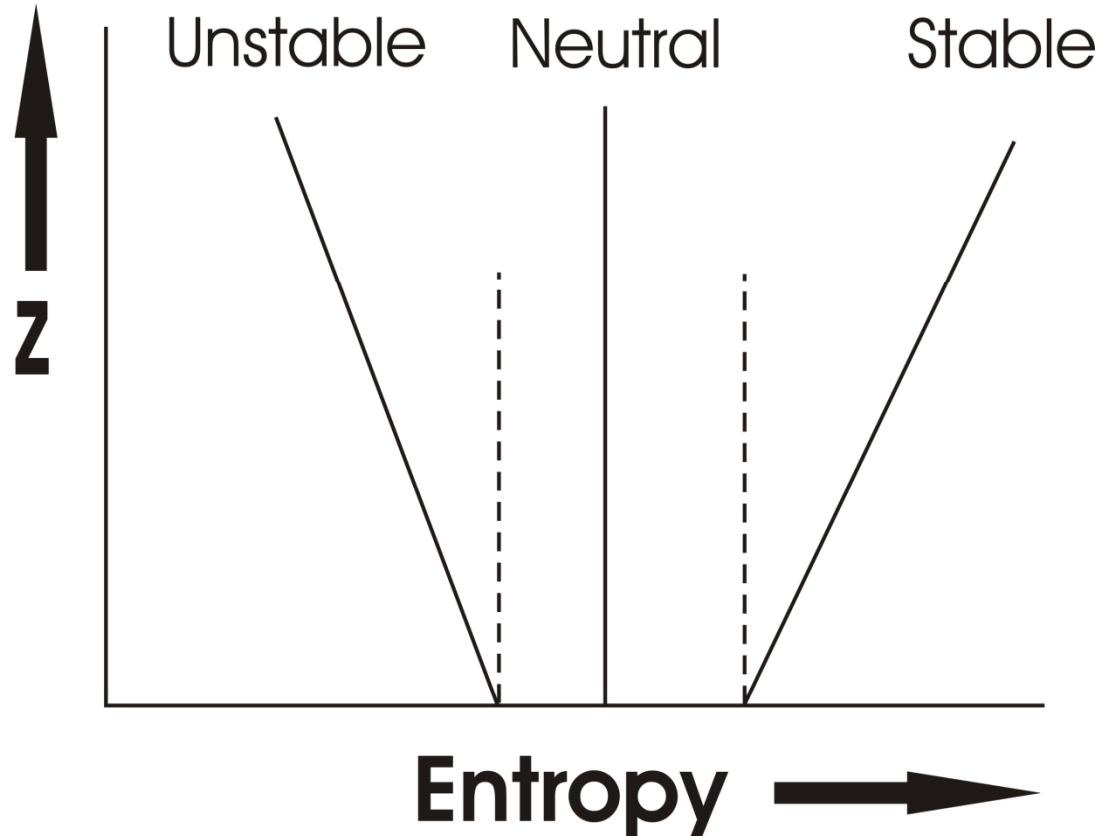

# Model Aircraft Measurements (Renno and Williams, 1995)

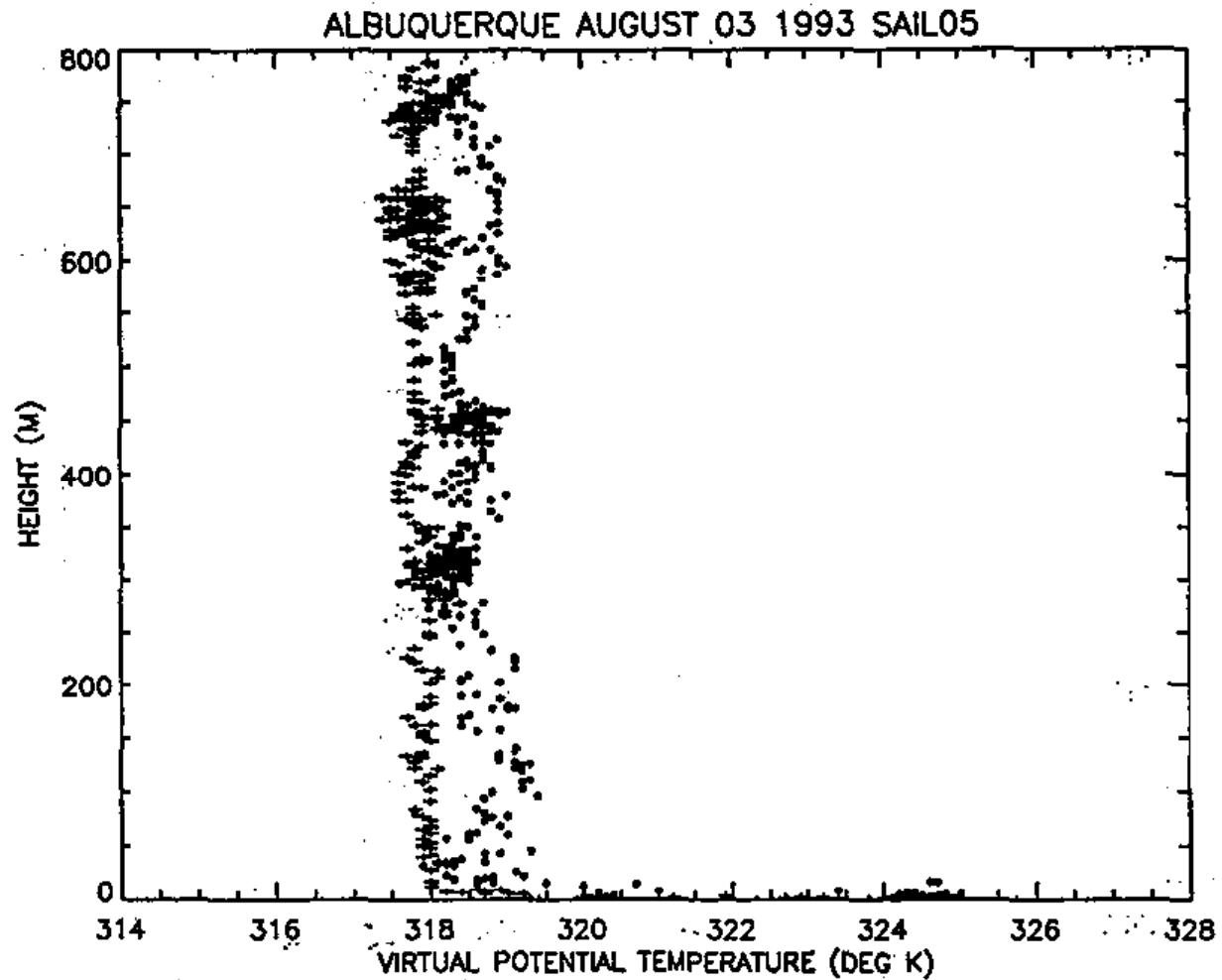

Radiative equilibrium is unstable in the troposphere

Re-calculate equilibrium assuming that tropospheric stability is rendered neutral by convection:

**Radiative-Convective Equilibrium**

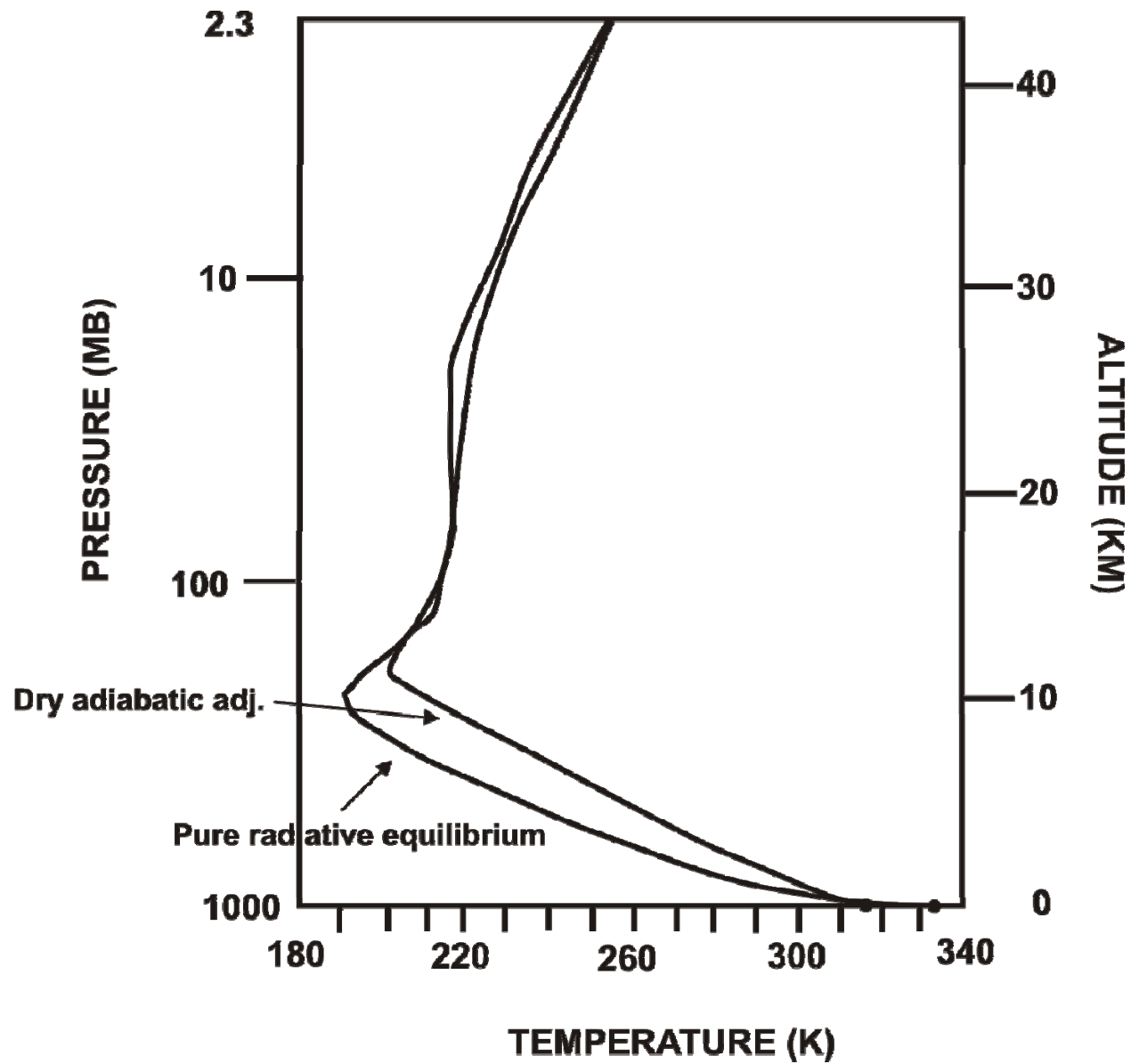

Better, but still too hot at surface, too cold at tropopause

Above a thin boundary layer, most atmospheric convection involves phase change of water:

## **Moist Convection**



# Moist Convection

- Significant heating owing to phase changes of water
- Redistribution of water vapor – most important greenhouse gas
- Significant contributor to stratiform cloudiness – albedo and longwave trapping



# Phase Equilibria

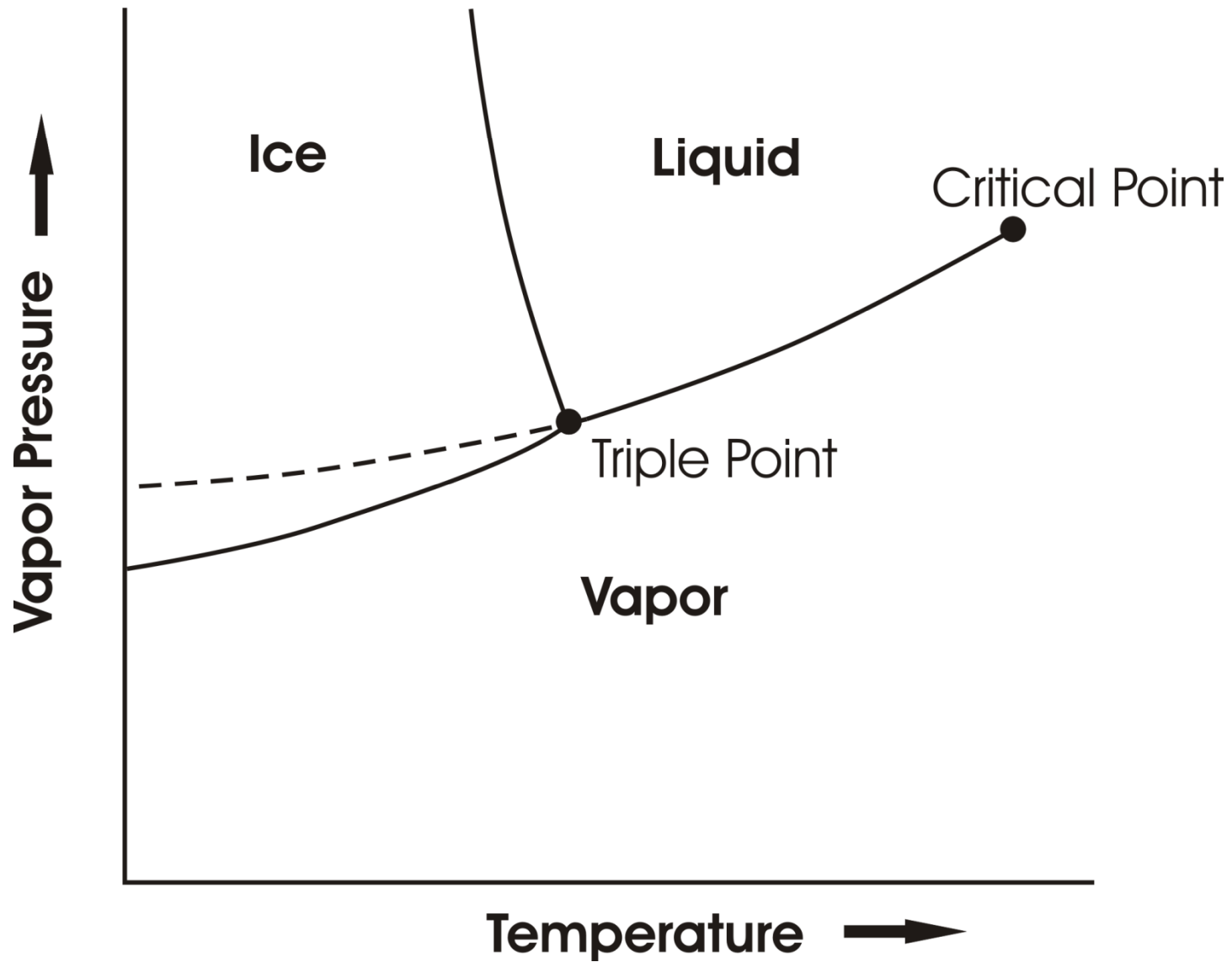

# When Saturation Occurs...

- Heterogeneous Nucleation
- Supersaturations very small in atmosphere
- Drop size distribution sensitive to size distribution of cloud condensation nuclei



# Precipitation Formation

- Stochastic coalescence (sensitive to drop size distributions)
- Bergeron-Findeisen Process
- Strongly nonlinear function of cloud water concentration
- Time scale of precipitation formation ~10-30 minutes

# Stability

No simple criterion based on entropy. But air inside ascending cumulus turrets has roughly the same density as that of its environment. It can be shown that neutral stability corresponds to the constancy of the *saturation entropy*  $s^*$ :

$$s^* = c_p \ln\left(\frac{T}{T_0}\right) - R_d \ln\left(\frac{p}{p_0}\right) + L_v \frac{q^*(T, p)}{T}$$

# Tropical Soundings

November - February

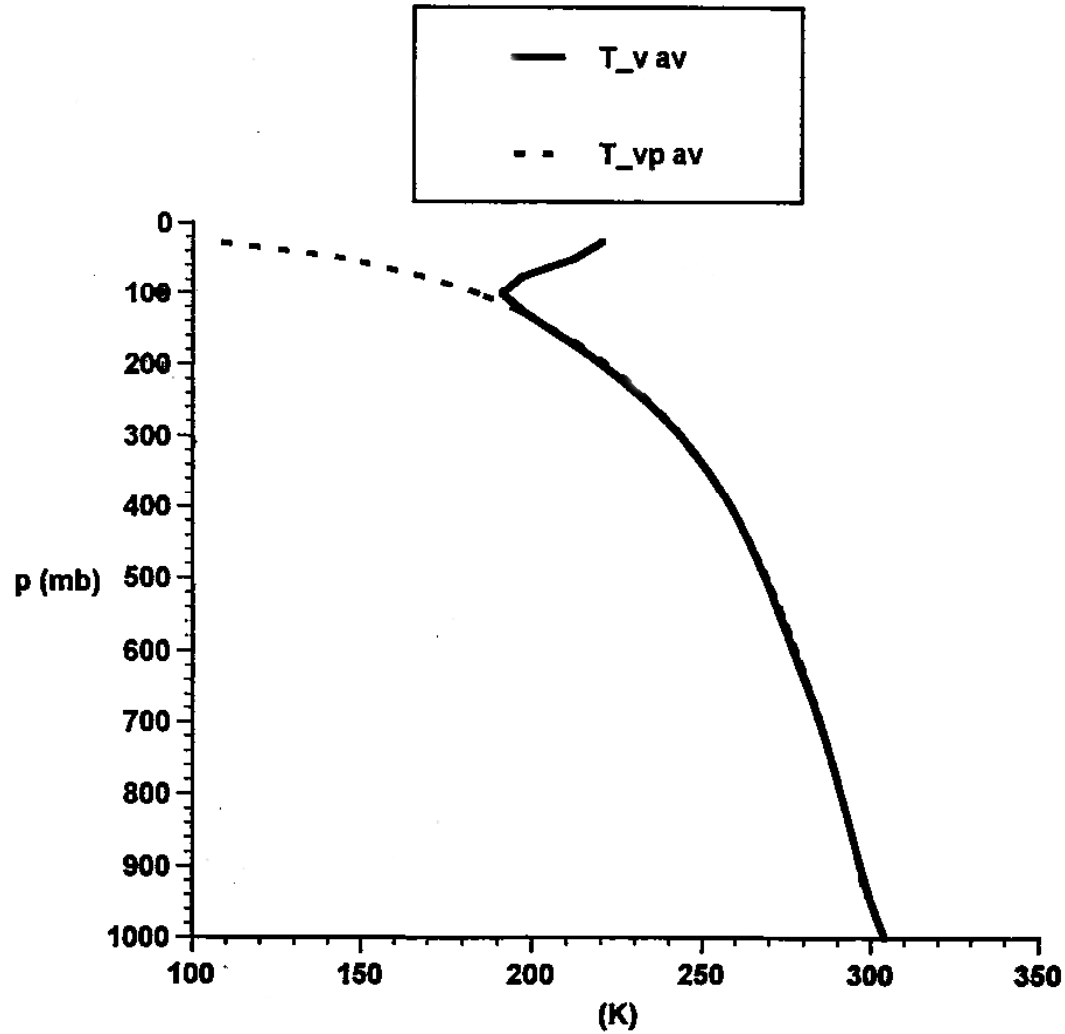

# Average density difference between reversibly lifted parcels and their environments, deep Tropics

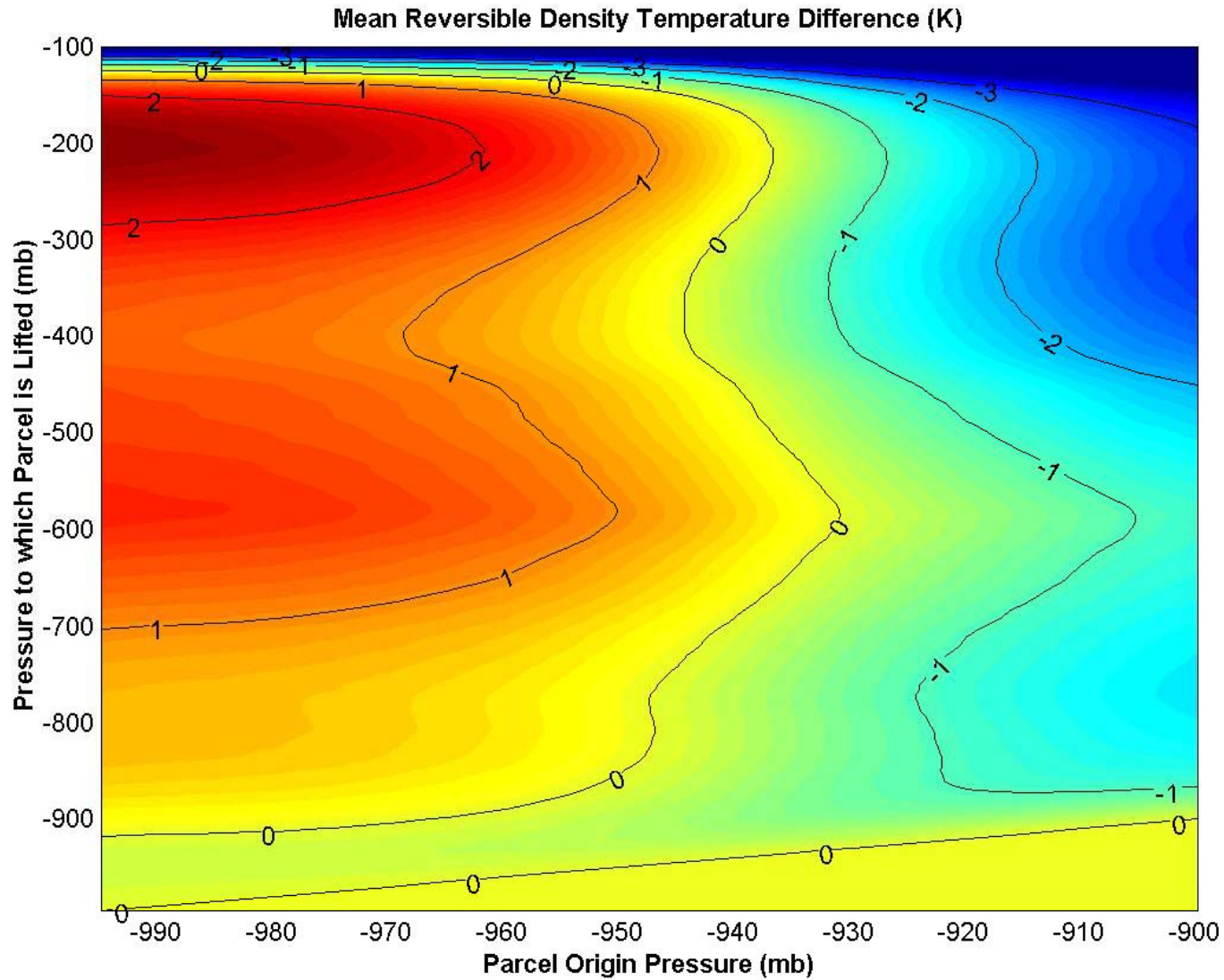

# “Air-Mass” Showers:

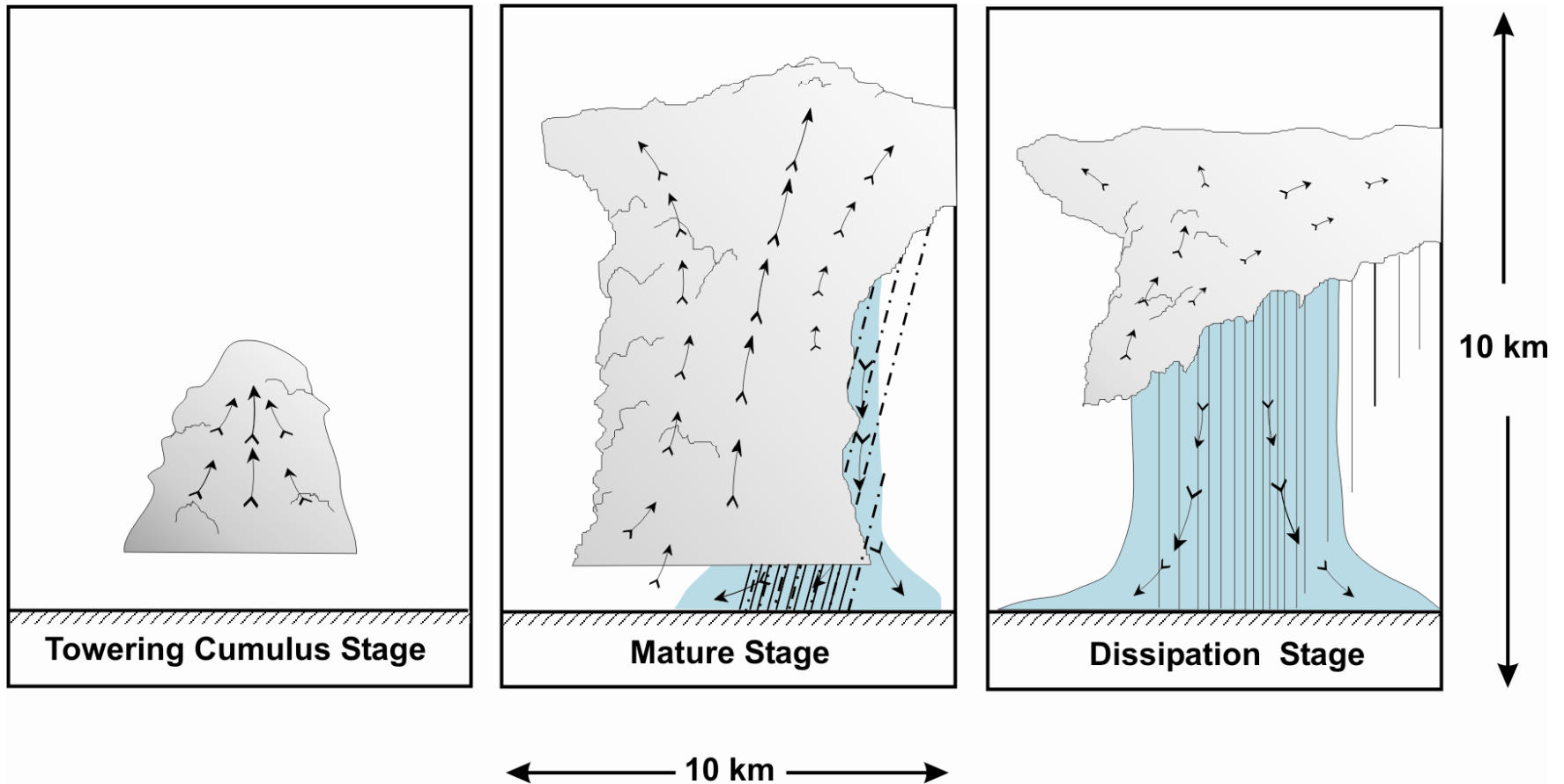



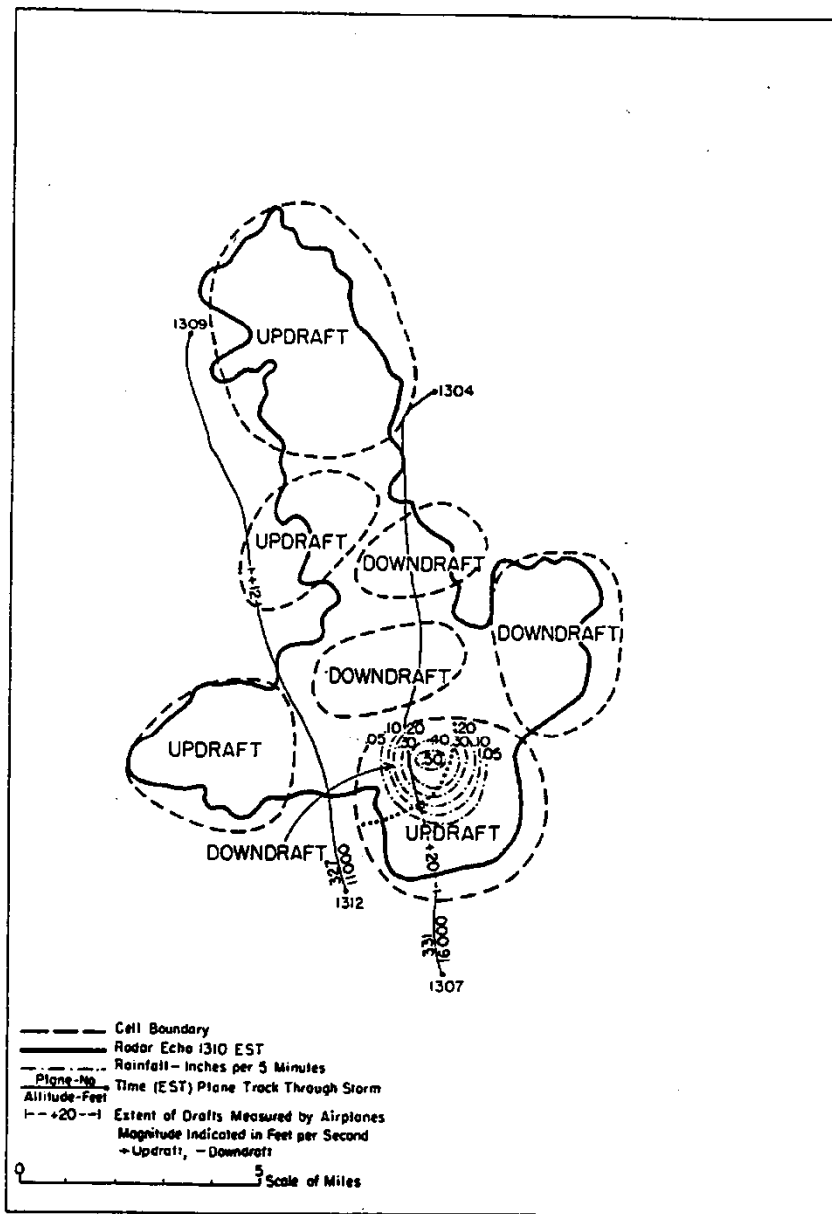

FIG. 15. Radar echo, plane paths, measured draft data, and cell outlines, 1310 EST 9 July 1946.

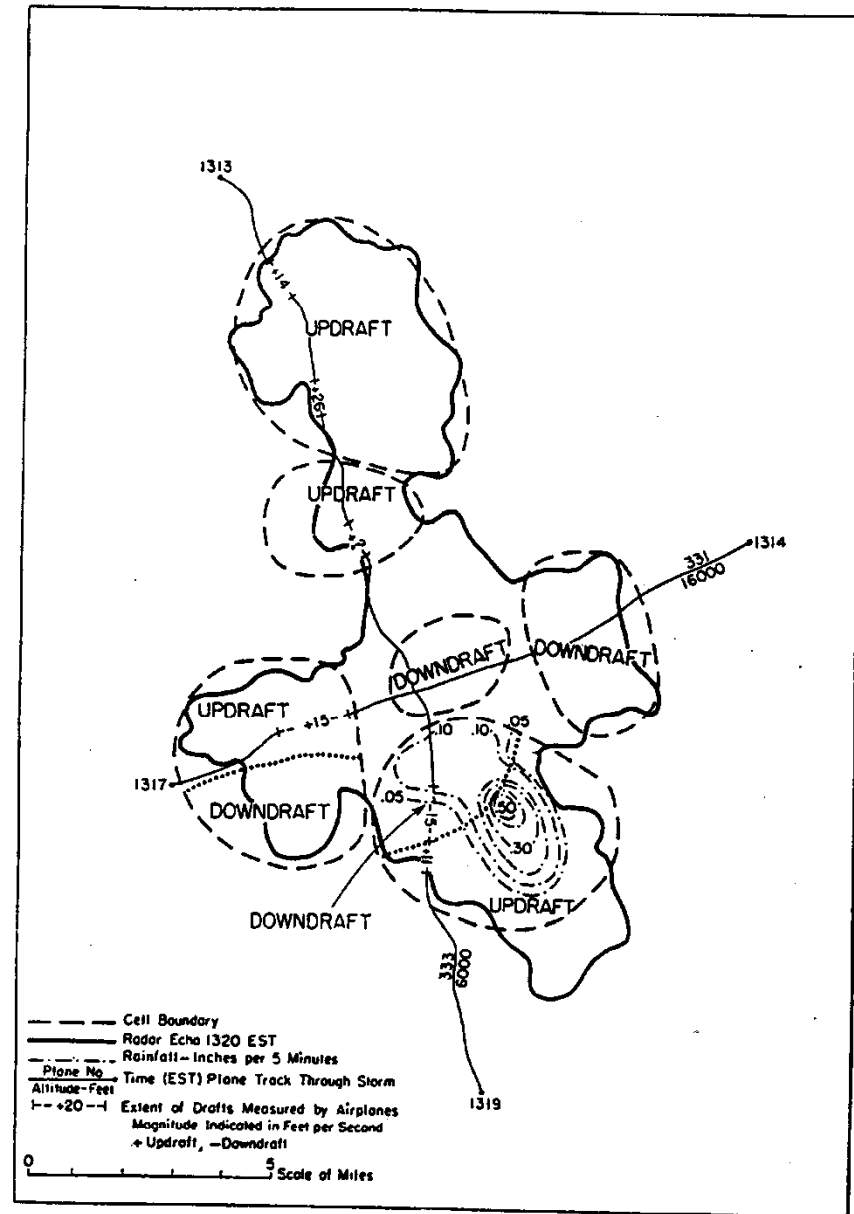
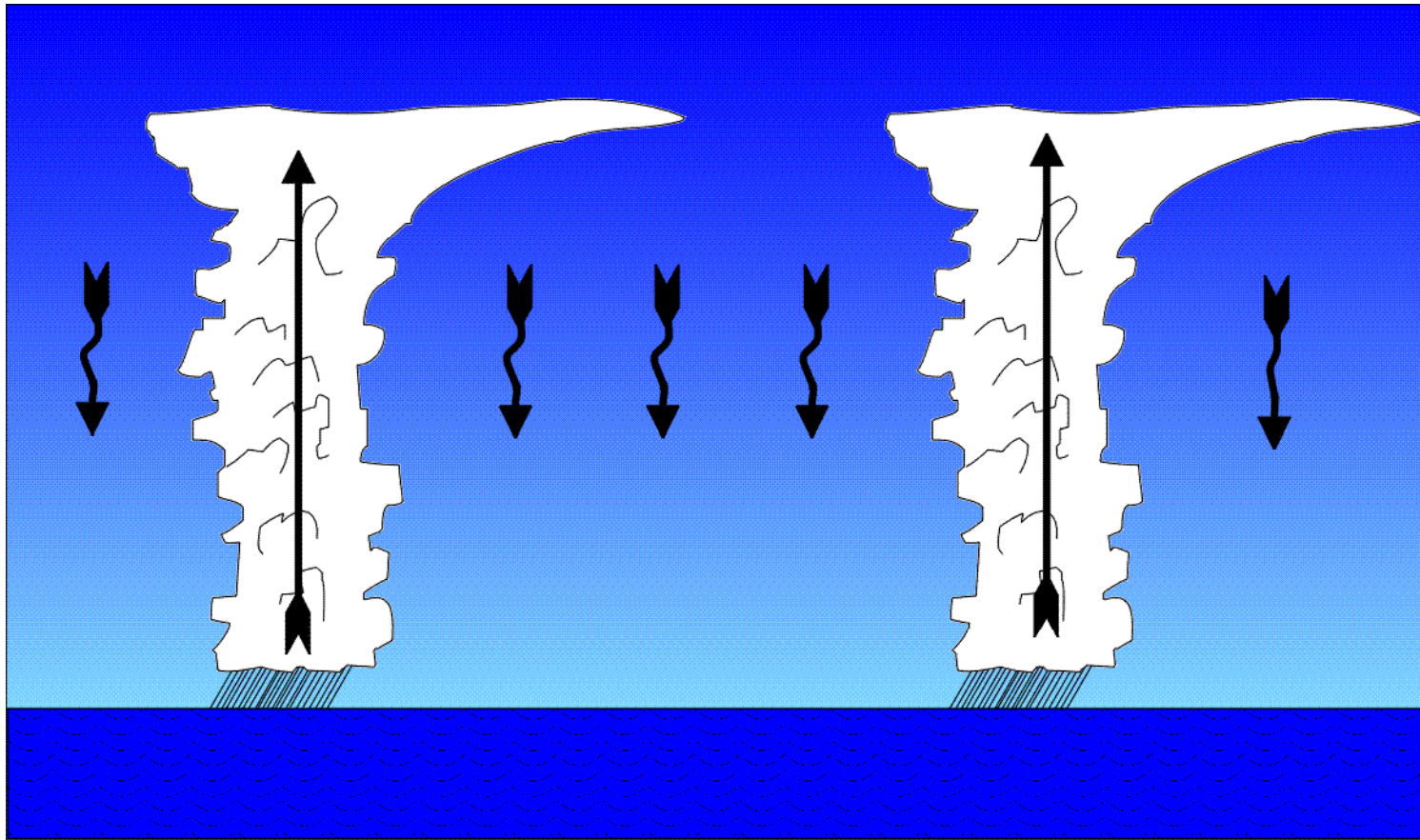

FIG. 16. Radar echo, plane paths, measured draft data, and cell outlines, 1320 EST 9 July 1946.



# Precipitating Convection favors Widely Spaced Clouds (Bjerknes, 1938)





# Properties of Moist Convection

- Convective updrafts widely spaced
- Surface enthalpy flux equal to vertically integrated radiative cooling
- $$M \frac{c_p T}{\theta} \frac{\partial \theta}{\partial z} = -\dot{Q}$$
- Precipitation = Evaporation = Radiative Cooling
- Radiation and convection *highly* interactive

# Simple Radiative-Convective Model

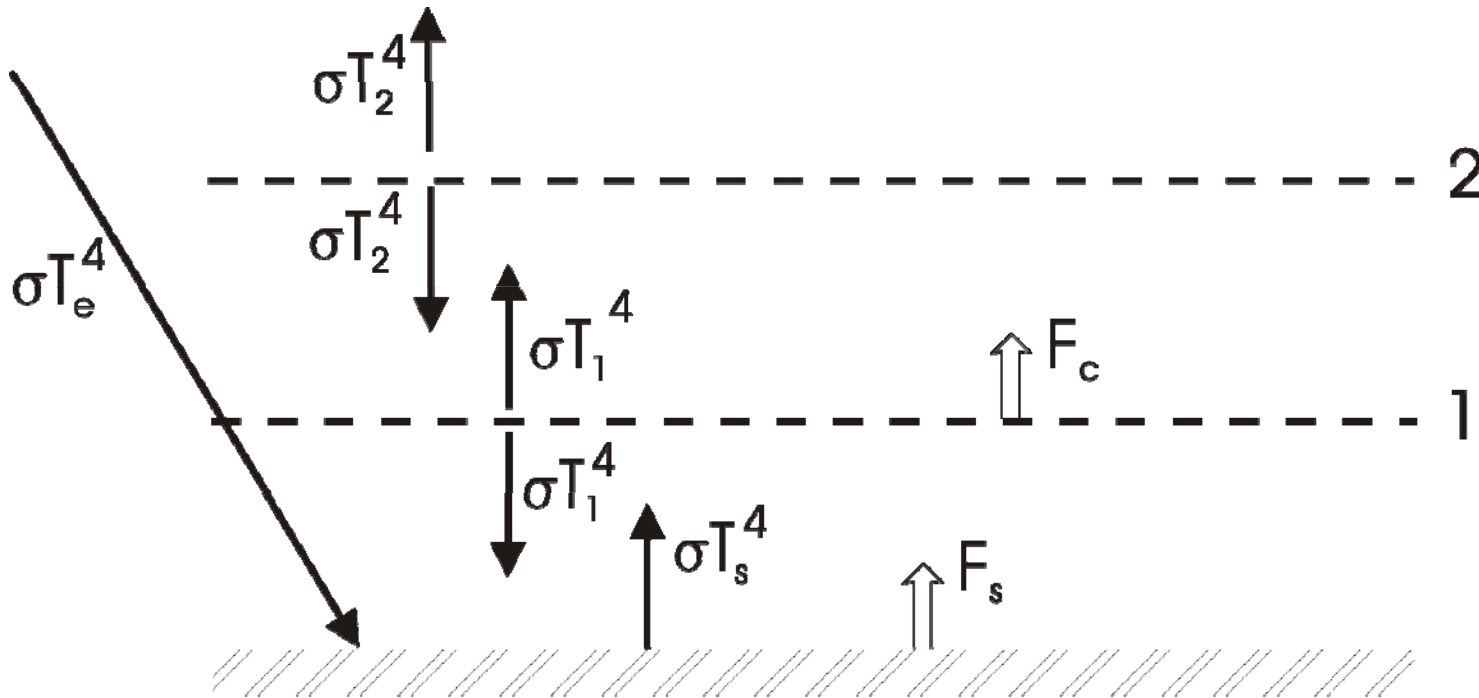

Enforce convective neutrality:

$$T_1 = T_2 + \Delta T,$$

$$T_s = T_2 + 2\Delta T$$

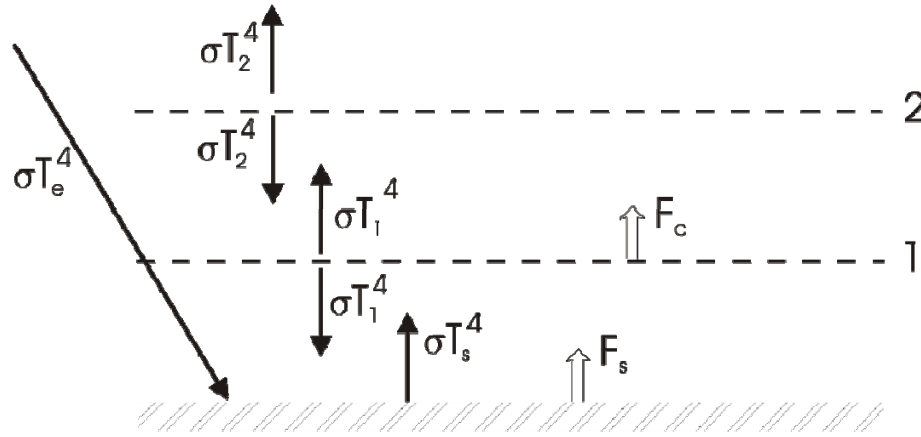

$$TOA: T_2 = T_e \rightarrow T_1 = T_e + \Delta T, \quad T_s = T_e + 2\Delta T$$

$$Surface: F_s + \sigma T_s^4 = \sigma T_e^4 + \sigma T_1^4$$

$$Layer 2: 2\sigma T_e^4 = \sigma T_1^4 + F_c$$

$$Define \quad x \equiv \frac{\Delta T}{T_e},$$

$$F_s = \sigma T_e^4 \left[ 1 + (1+x)^4 - (1+2x)^4 \right],$$

$$F_c = \sigma T_e^4 \left[ 2 - (1+x)^4 \right]$$



# Manabe and Strickler 1964 calculation:

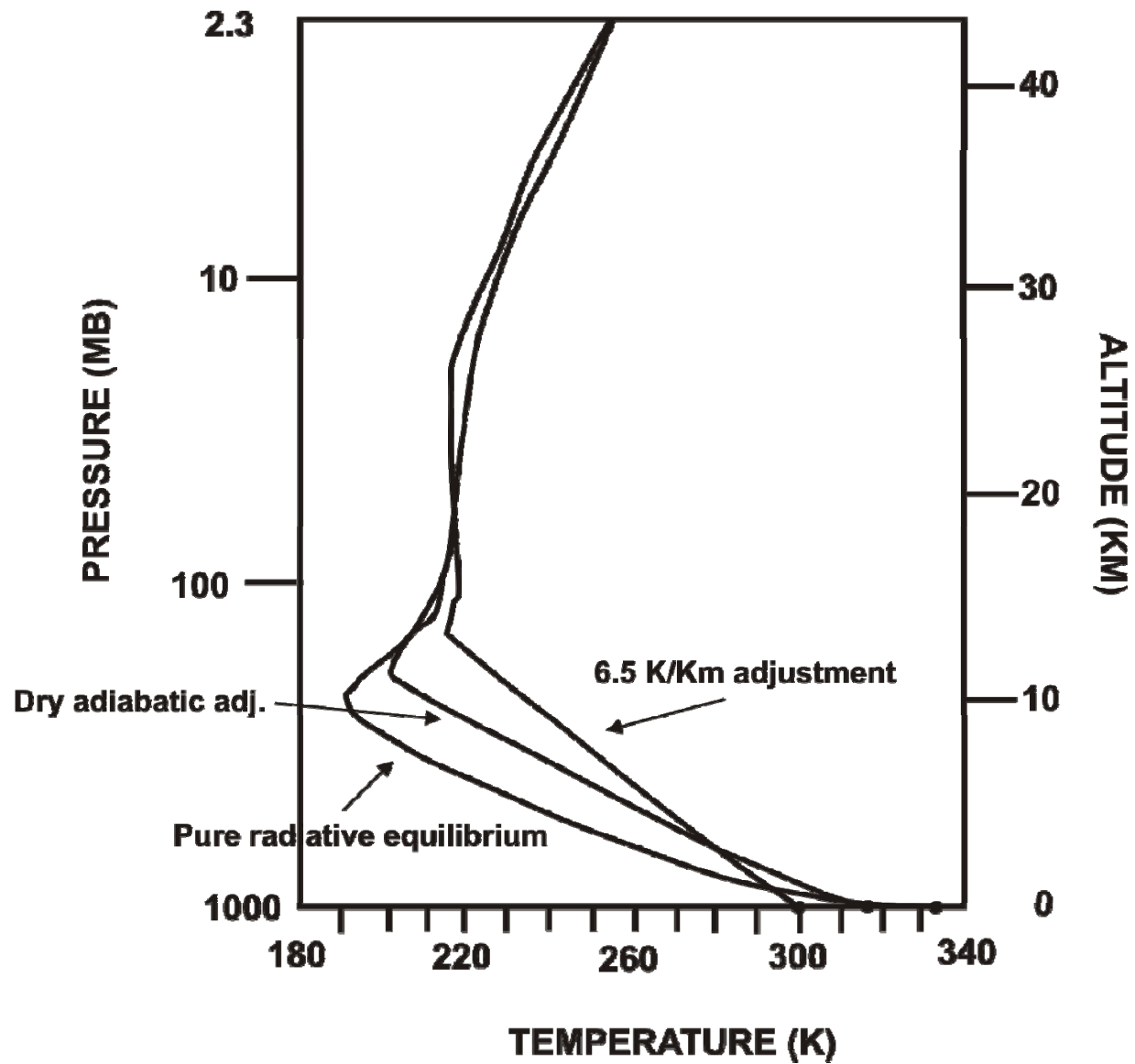



# Effect of Moist Convective Adjustment on Climate Sensitivity

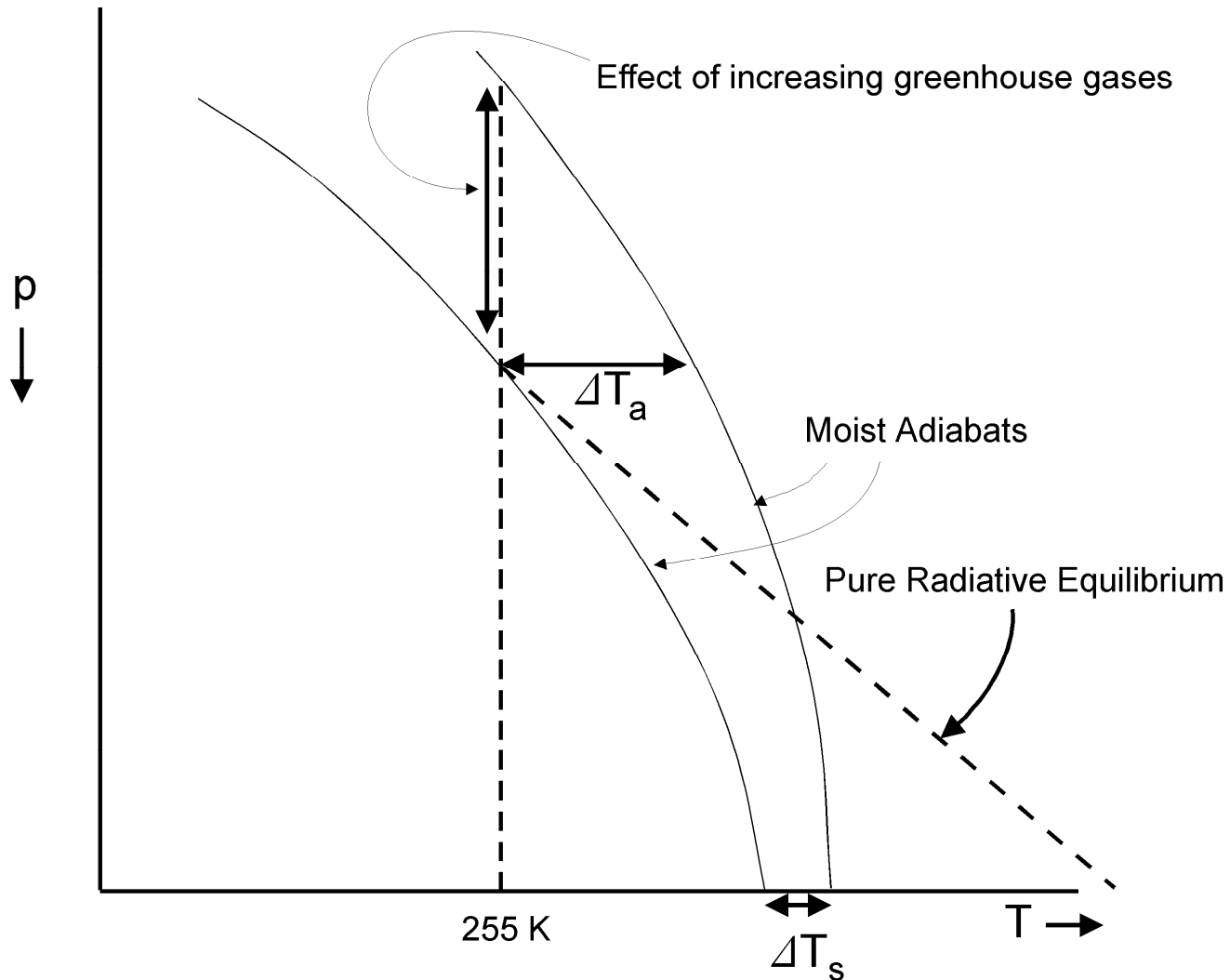

Flux of water by convection makes real problem complex

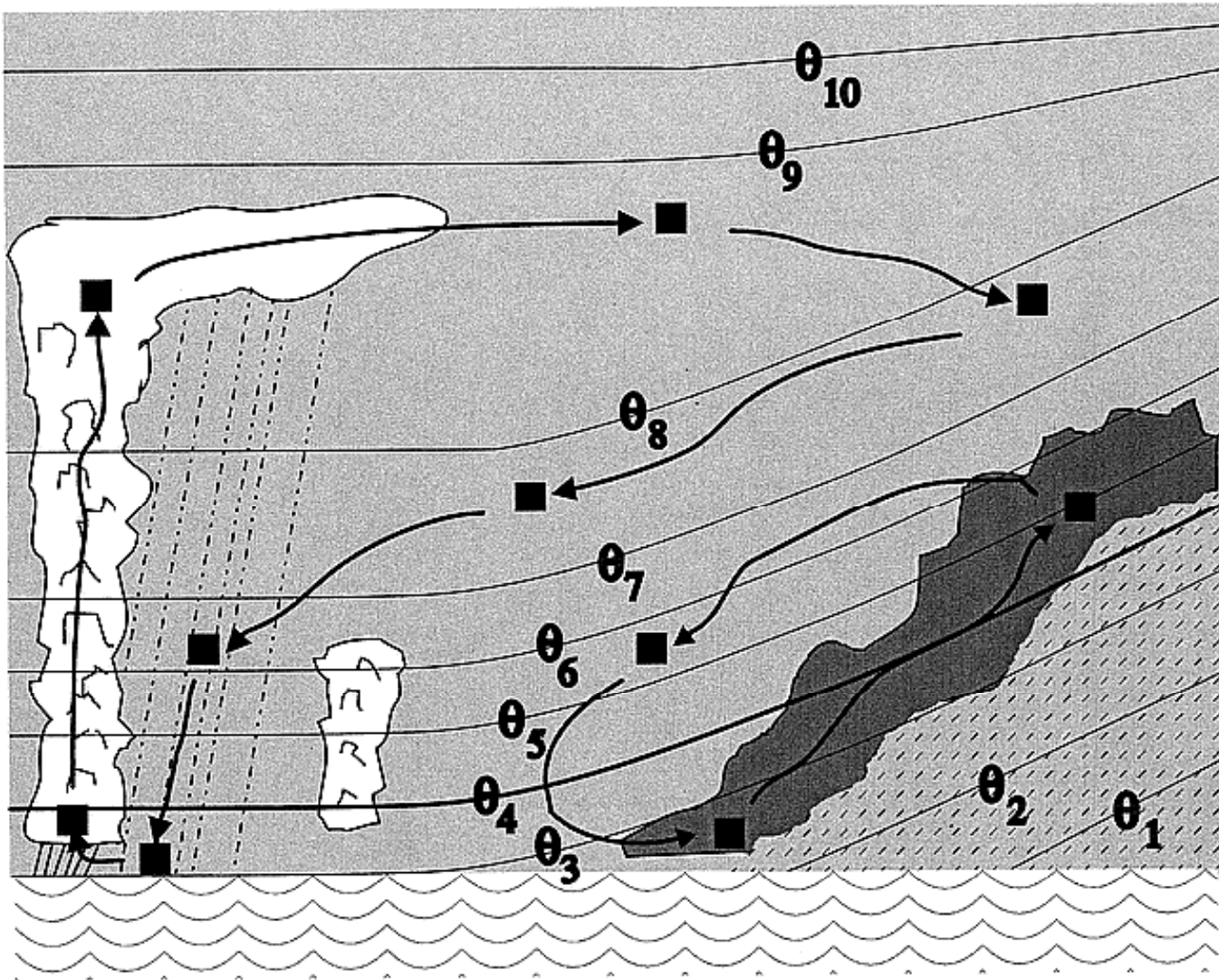



[www.ghcc.nasa.gov](http://www.ghcc.nasa.gov)

1 Sep 2000  
19:15 UTC

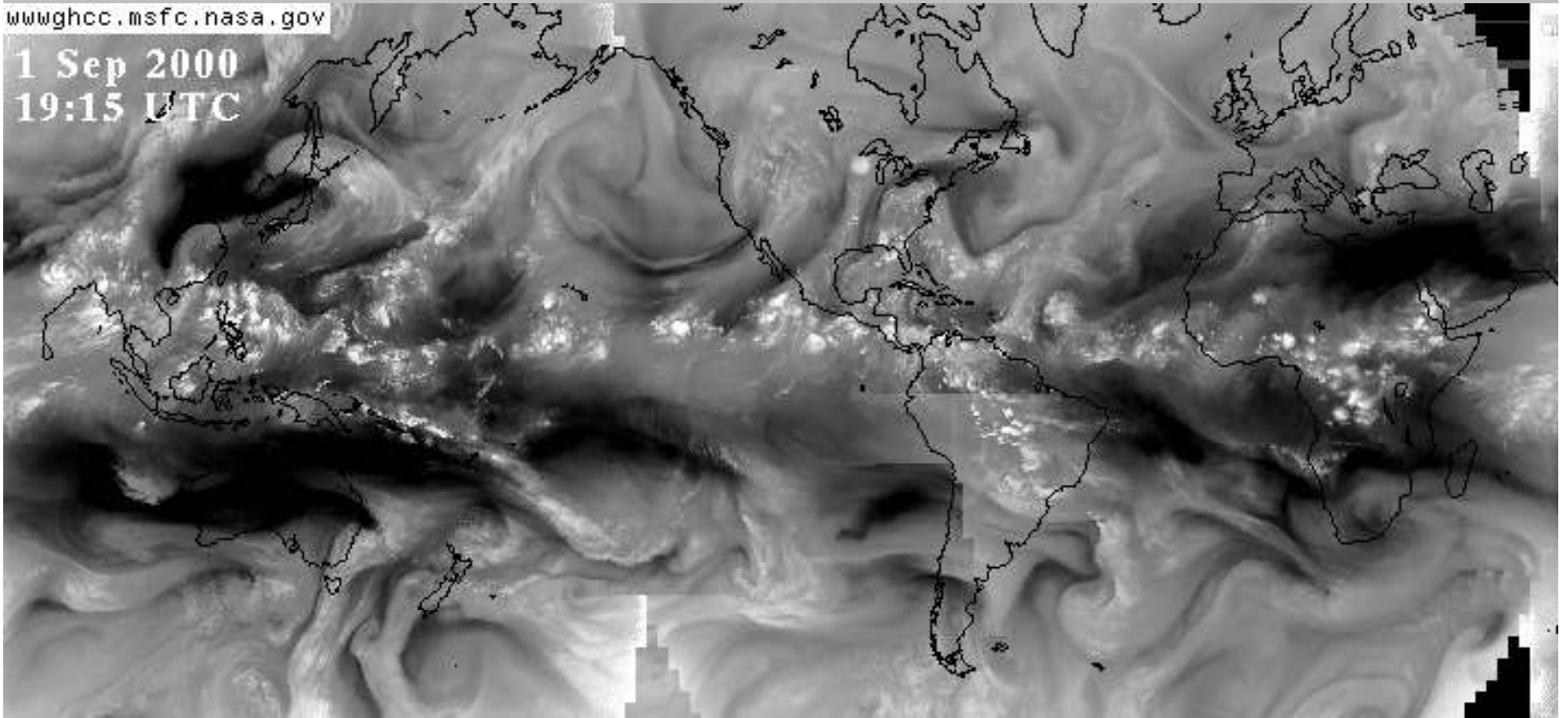



Frequency histogram of rawinsonde relative humidities from 1600 ascents at the tropical Pacific islands of Yap, Koror, Ponape and Majuro, January-May, 1994-95. Spencer and Braswell, *Bull. Amer. Meteor. Soc.*, 1997.

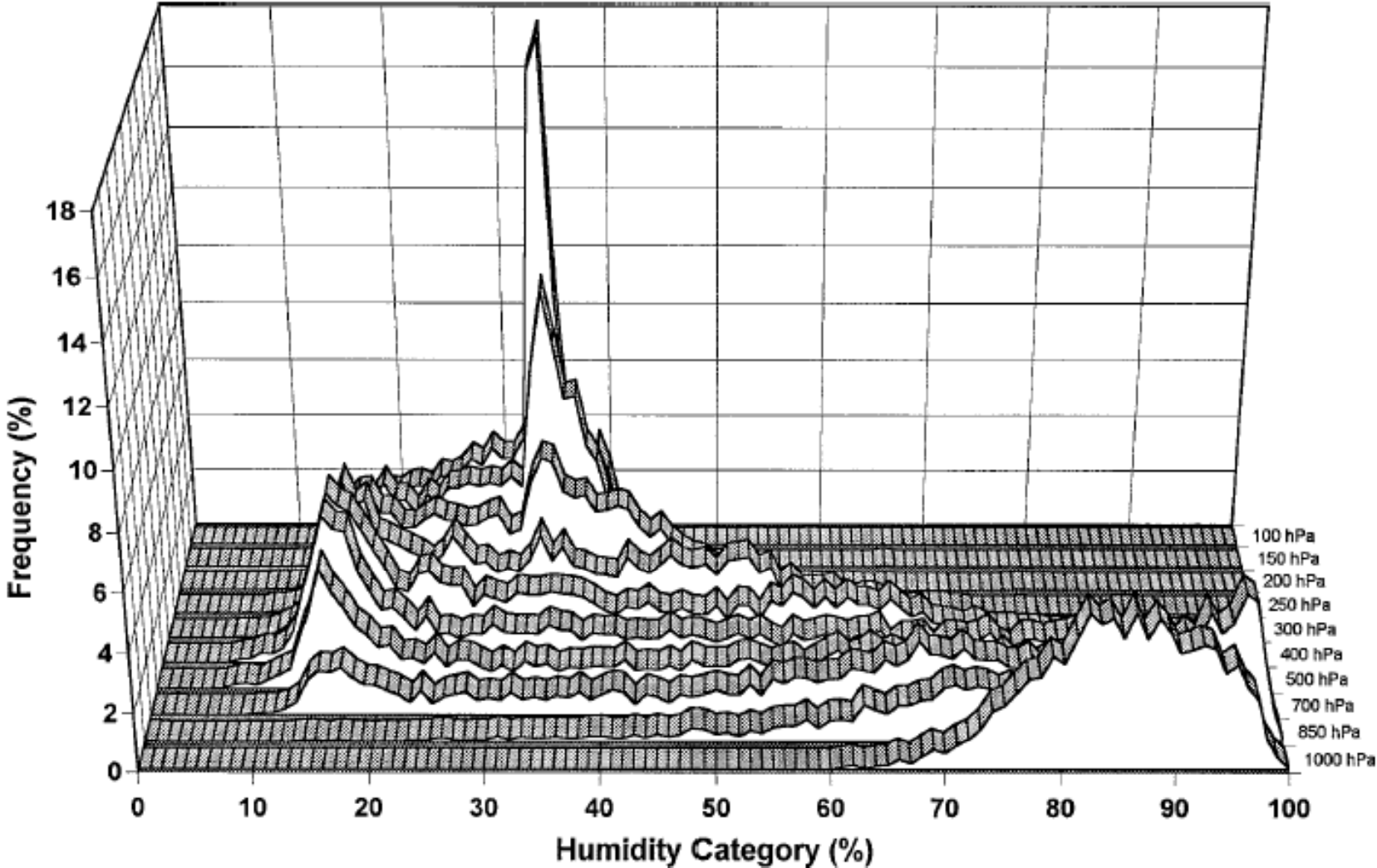

# Effects of Clouds on Radiative Transfer

- Responsible for much of Earth's albedo
- Important greenhouse effect from longwave absorption and re-emission

# Globally Averaged Energy Balance

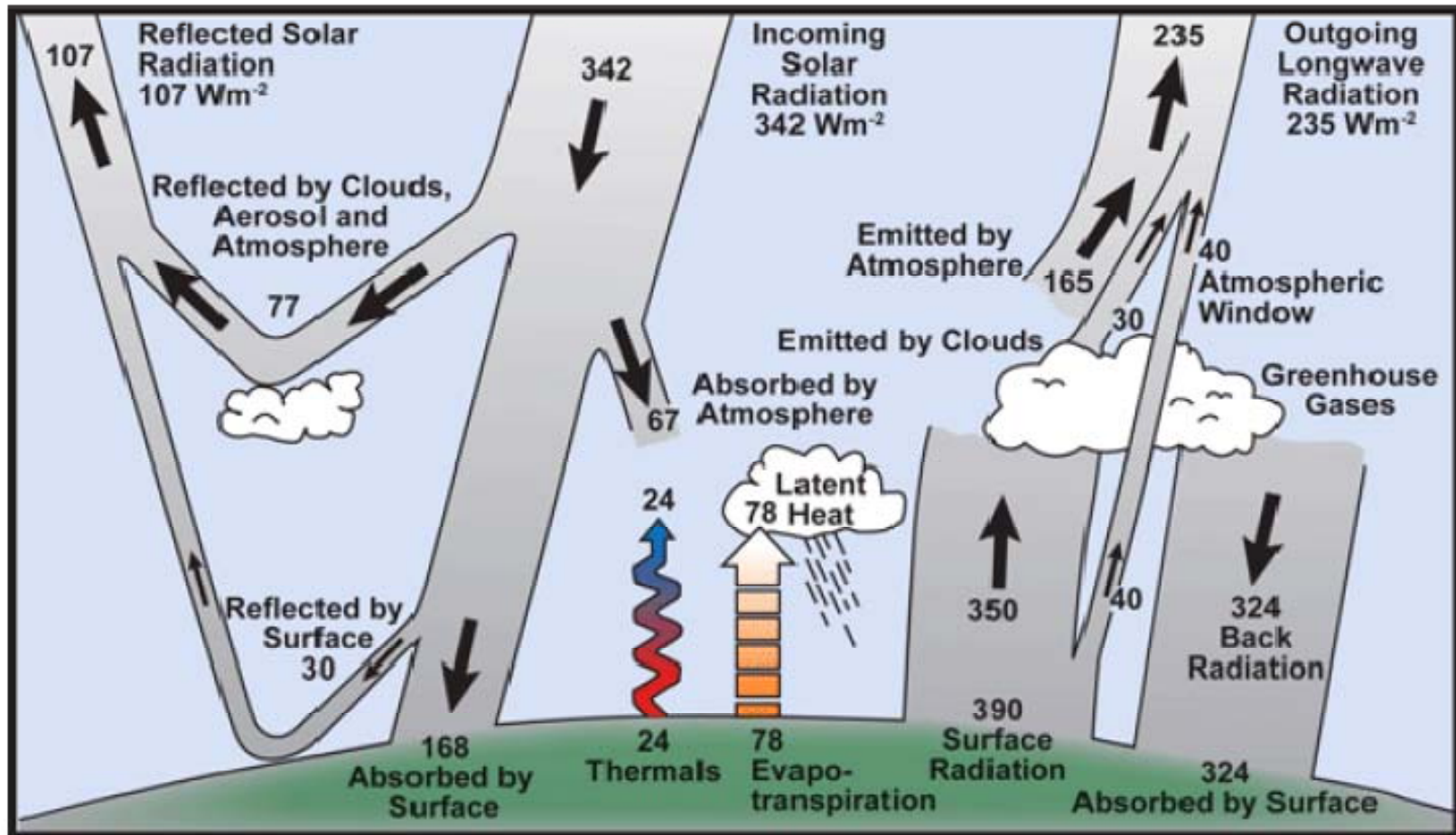

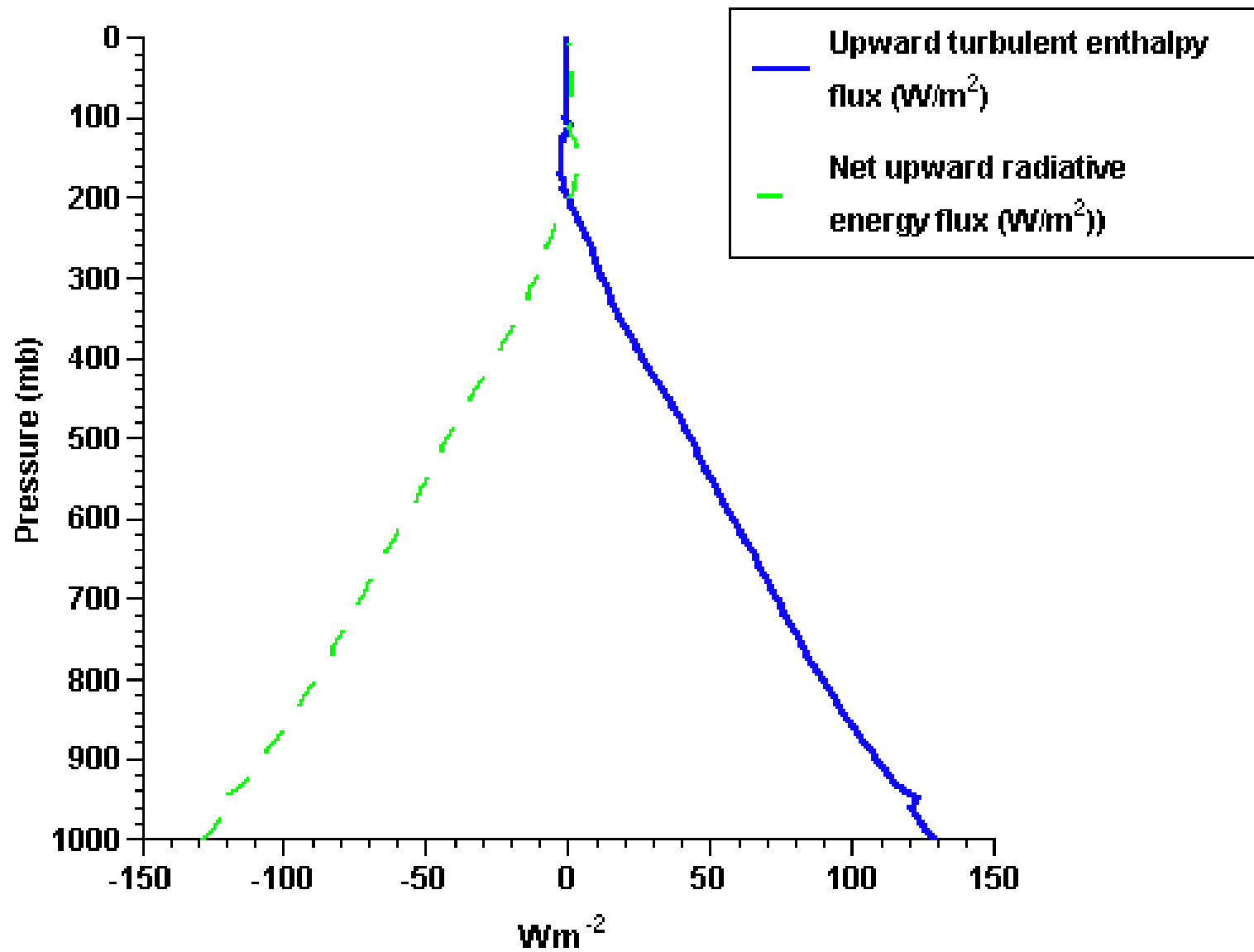



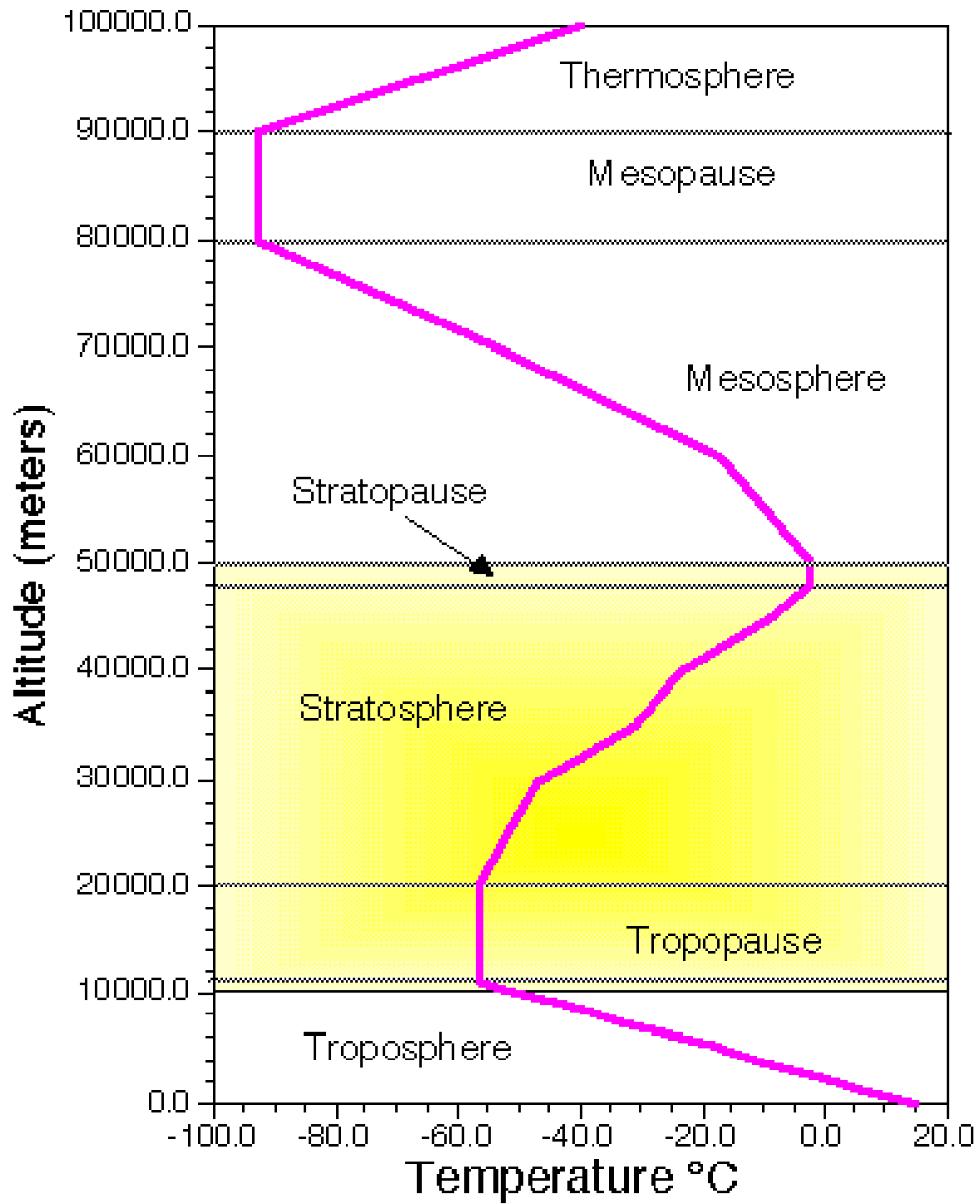

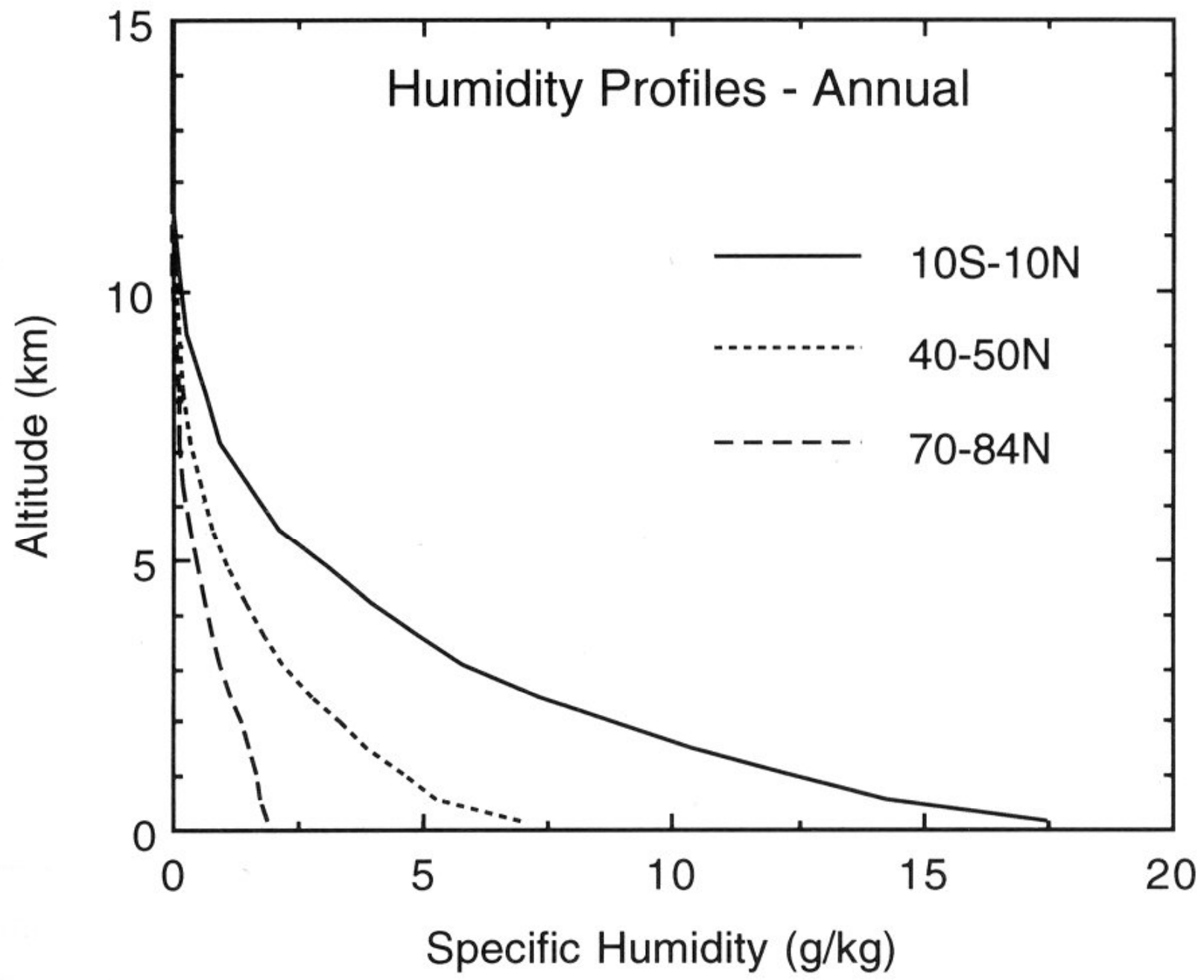

# Radiative-Convective Model

- Band-averaged radiation
- Radiation interacts with  $\text{H}_2\text{O}$ ,  $\text{CO}_2$ ,  $\text{O}_3$ , clouds
- Two-stream approximation: radiation assumed to travel vertically
- Moist convection whenever instability exists
- Convection transports  $\text{H}_2\text{O}$ , enthalpy
- Representation of layered clouds

## Open MATLAB

Type “run\_model”

- 1) Restart from last run? [n]
- 2) Interactive radiation? [y]
- 3) Interactive clouds? [y]
- 4) Interactive surface temp? [n]
- 5) Time-dependent radiation? [n]
- 6) Date-dependent radiation? [n]
- 7) Diurnal-average radiation? [n]
- 8) Annual-average radiation? [y]
- 9) Surface albedo [0.32]
- 10) Amount of CO2 [360 ppm]
- 11) End time of integration [100 days]
- 12) Graphics averaging time [1 days]
- 13) Frequency of radiation calls [3 hours]
- 14) Frequency of graphics output [2 hours]
  
- 0) Run model with current configuration.